

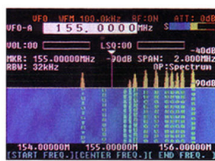

FREQUENCY MONITOR UNIT

SR2000A

HIGH SPEED FFT SIGNAL ANALYSIS



INSTRUCTION MANUAL

AOR, LTD.

TABLE OF CONTENTS

	Table of contents	1
1	Introduction	3
	1-1 Maintaining the unit	3
	1-2 Power requirements	4
	1-3 Supplied accessories	4
	1-4 Features	4
2	Control and functions	5
	2-1 Front panel controls	5
	2-2 Rear Panel	7
3	Connections	9
4	Power Switch	9
	4-1 Start up	9
	4-2 Powering down	9
5	Operations of the SR2000A	9
	5-1 Display	9
	5-2 Key commands	13
6	Monitoring Modes	14
	6-1 Basic operations – VFO mode (manual mode)	14
	6-1-1 Setting up the monitoring frequency	14
	6-1-2 Setting up the receive mode	17
	6-1-3 Audio Gain Control	18
	6-1-4 Squelch control	18
	6-1-5 RF attenuator and preamplifier settings	19
	6-1-6 Mute volume and open squelch (monitor).....	19
	6-1-7 Input sensitivity (amplitude)	20
	6-1-8 Resolution bandwidth (RBW)	20
	6-1-9 Waterfall display function	21
	6-1-10 Selecting the operation modes	22
	6-2 Operation Modes	23
	6-2-1 Spectrum analyzer mode	23
	6-2-2 Step resolution mode	24
	6-2-3 Channel scope mode	25
	6-3 Marker functions	27
	6-4 Calculation function	29
	6-5 Video monitor function	30
7	Configuration	32
	7-1 Resetting the SR2000A	34
8	Memory channels	35
	8-1 Memory read mode	35
	8-2 Memory scan	36
	8-3 Programming the memory	37
	8-4 Memory text input	38
	8-5 Selected memory scanning	39
	8-6 Priority monitor	40
9	Frequency Offset	41
10	Normal Search and FFT Search	42
	10-1 Programming Search banks	42
	10-2 Normal Search	44
	10-3 Frequency Pass setup	45
	10-4 FFT Search	46
	10-4-1 Search banks and FFT search	46
	10-4-2 FFT search setup	46
	10-4-3 FFT search results	47

11	Delete menu -----	49
12	Computer control information -----	50
	12-1 Command list -----	52
	12-2 Command details -----	53
13	Specifications -----	64
14	Limited warranty (US only) -----	65

1 Introduction

Thank you for purchasing the SR2000A Frequency Monitor. The SR2000A is a worthy successor to the SR2000 and is the next generation in frequency monitors. Using a five-inch TFT color display, DSP (Digital Signal Processing) and FFT (Fast Fourier Transform) it provides faster sampling rates and color imaging, a video display function, optional APCO25 (P25) decoder, thus the SR2000A opens the door to new possibilities and applications. We put the power of FFT algorithms to work in tandem with a powerful receiver, continuous coverage from 5 MHz ~ 3 GHz (Cellular blocked for US consumer version). The result is a compact color spectrum display monitor that's ultra-sensitive, incredibly fast and yet easy to use. The SR2000A is perfect for base, mobile or field use and can also be used in combination with a personal computer. Every effort has been made to make this manual correct and up to date however due to continuous development of the product and by error or omission, anomalies may be found and this is acknowledged.

This manual is protected by copyright AOR, LTD. 2013. No information contained in this manual may be copied or transferred by any means without the prior written consent of AOR, LTD. AOR and the AOR logo are trademarks of AOR, LTD. All other trademarks and names are acknowledged.

1-1 Maintaining the unit

There are no internal operator adjustments. In the unlikely event of service being required, please contact your dealer for technical assistance.

Level of risk

As the SR2000A is powered from 12V DC, there is little chance of serious injury as long as common sense is applied.

Observe the polarity of connections if supplied AC power units is not being used. DC input is a nominal 12V DC, with the connector wired center conductor positive. Reverse polarity connection will damage the SR2000A and could lead to the risk of fire or explosion under severe circumstances.

Carefully handling of the AC plug of the supplied AC power unit is essential to prevent touching the terminals when inserting or removing from the AC plug. NEVER connect the SR2000A directly to the AC outlet.

Handling the SR2000A

Use a soft, dry cloth to gently wipe the SR2000A clean. Never use abrasive cleaners or organic solvents which may damage certain parts. Treat the unit with care and avoid spillage or leakage of liquids into the cabinet and power supply. Special care should be taken to avoid liquid entering around the keys, main dial or via the connectors.

[Note: Never push or knock the LCD screen, it is very fragile and sensitive to shock.]

Special remarks

Do not use or leave the SR2000A in direct sunlight (especially the TFT display). It is best to avoid locations where excessive heat, humidity, dust and vibration are expected. Always keep the SR2000A free from dust and moisture.

1-2 Power requirements

The SR2000A may be provided with a suitable AC/DC power unit, if you are using any other power supply then you should take note that the SR2000A is designed for operation from a nominal 12V DC regulated power supply (12 to 14V is acceptable), which should be capable of supplying a minimum of 1.5A continuous. Ideally a 2A power supply unit should be used.

[Note: Never connect the SR2000A directly to an AC outlet.]

[Safety Notice: Always disconnect the power supply from the AC outlet when not in use.]

Should the SR2000A appear to behave strangely, normal operation may be resumed by resetting the microprocessor. Please refer to section [7. Configuration] for further information.

1-3 Supplied accessories

The following accessories are provided in the box.

Quantity 1	Printed instruction manual
Quantity 1	USB driver & software on CD
Quantity 1	AC adapter
Quantity 1	DC cable

1-4 Features

- **FFT (Fast Fourier Transform) high speed display**
The FFT search function enables incredibly high-speed signal monitoring, 10 MHz search in approximately **0.07 seconds!**
- **Displays up to 40MHz of spectrum bandwidth**
Up to 40 MHz of bandwidth can be displayed in real time through advanced Digital Signal Processing. (No audio is available when the frequency span is set to 20 MHz or 40 MHz)
- **5 inch TFT color LCD display**
With a 5-inch TFT color display it is easy to monitor the clear, crisp images of received signals.
- **Waterfall (time) display function**
Tracks signals over time and uses colors to define their strength.
- **Average or peak value readings**
- **Frequency coverage**
25 MHz ~ 3 GHz (Cellular Blocked for US consumer version)
- **Ultra-stable, high sensitivity triple conversion receiver**
- **AM/NFM/WFM/SFM receive modes**
- **Video display mode (NTSC, PAL format)**
- **1000 memory settings**
100ch x 10 memory banks
- **Easy menu-driven operation**
- **PC control through serial port or USB interface**
- **APCO25 (P25) decoder** (Optional decoder board required)

2 Controls and functions

2-1 Front panel controls

The front panel of the SR2000A is dominated by the large color LCD. Controls are 'grouped' to assist efficient operation; there are a total of 26 keys in addition to the power on/off switch and the rotary dial encoder.

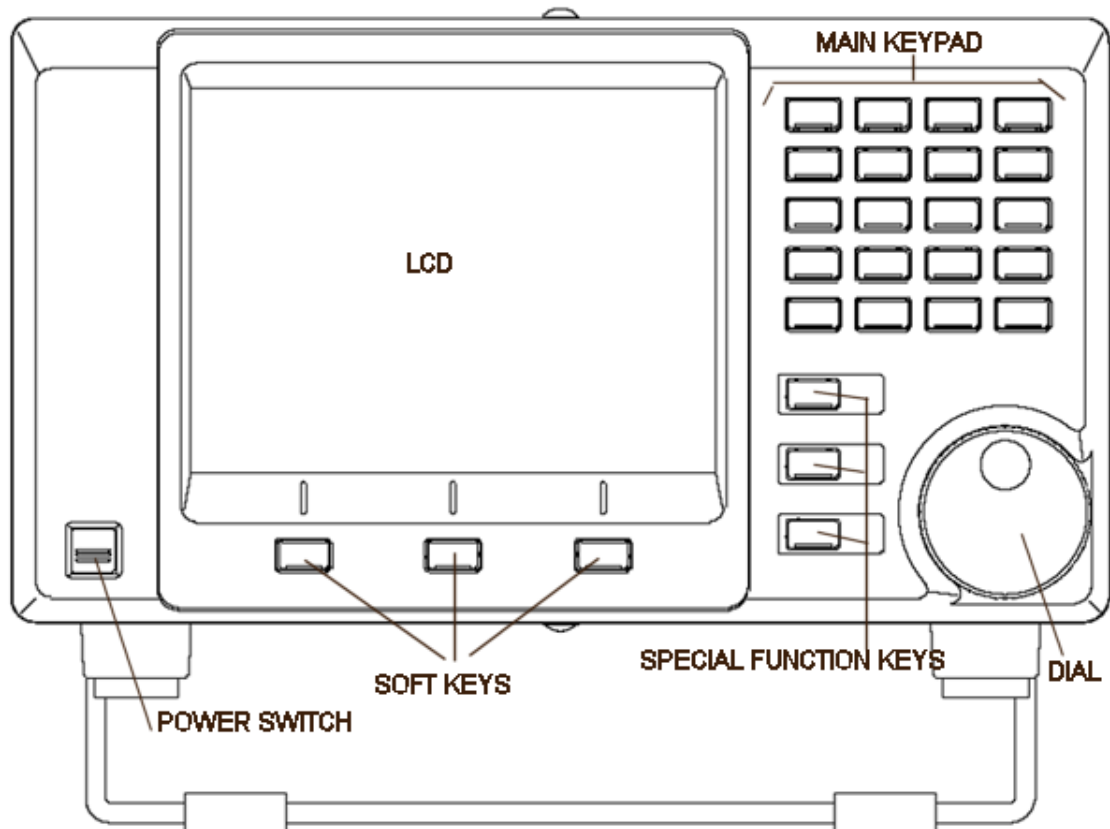

1 Power switch

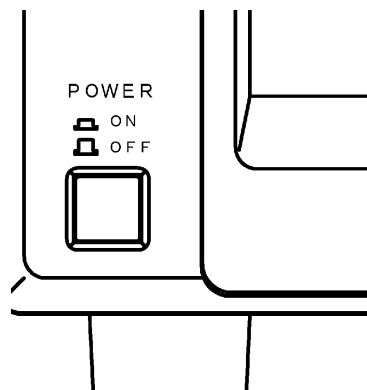

Press once to latch the switch in, switching on the SR2000A.
To switch off the SR2000A, press the switch again, the switch releases outward.

1 LCD (Liquid Crystal Display)

The large high resolution (320 x 240 pixels) 5-inch color TFT display provides all operational information and spectrum display.

2 Soft function keys

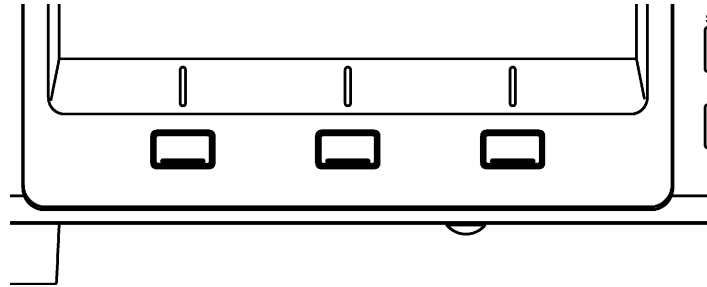

Each one of the three [soft keys] has multiple roles which are indicated on the LCD screen depending on the circumstances of the operation.

3 Dial knob

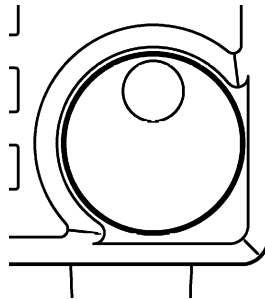

The rotary dial knob is a multi-function rotary control and is used to move the cursor, to make a selection, to move the marker/center frequency and to tune to the desired frequency.

4. Main keypad

There are 20 main keys including numeric keys. Some keys have secondary functions, and the functions are printed above each respective key. To access the secondary function, press the [FUNC] key located at the top right of the control keys, then press respective key.

5. Special function keys

Three (3) special function keys are provided with the SR2000A. These keys are used to change the function of the dial knob to either set the center frequency, squelch level or alter the volume (audio output).

2-2 Rear panel



ANT

This is the antenna input for the SR2000A. The connector is a BNC type. Use 50 Ω cable to connect your antenna.

DC 12V

The supplied power unit is terminated with a center positive (+) polarity connector.

PHONES

Headphone jack (3.5mm stereo type):

A pair of headphones or earphones may be connected.

When this headphone jack is used, the internal speaker will be automatically disabled.

EXT.SP

External speaker jack: This 3.5mm mono jack provides audio output to drive an external speaker unit. This unit should have a nominal 8- Ω impedance and power handling of 2 Watts or greater.

VIDEO OUT

This RCA connector provides the composite video output; an external video monitor may be connected.

ACC

Accessory connector: Provides output for audio and discriminator. See below.

REMOTE 1

USB interface connector: use a USB-A to USB-B cable (not supplied) to connect your PC.

You can either use the USB driver included in the CD, or the USB driver which can be downloaded from the following URL:

<http://www.ftdichip.com/ftdrivers.htm>

Click [VCP Drivers]: then select the device number [FT232B].

REMOTE 2

RS-232C serial interface connector: Use a DB-9 serial cable to connector your PC.

(Caution: The REMOTE 1 and the REMOTE 2 cannot be used simultaneously.)

INTERNAL SPEAKER (TOP PANEL)

Internal speaker.

ACC CONNECTOR PIN ASSIGNMENT

This connector provides output for audio and the discriminator, or for other applications you might wish to create. Refer to the pin assignment indicated in the chart below.

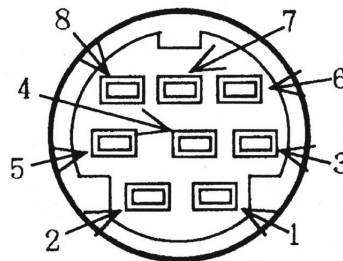

PIN NUMBER	CONNECTION
1	5V DC output @30 mA max.
2	Discriminator output (500 mV p-p)
3	10 MHz IF output
4	NC
5	NC
6	AF out (H) 120 mV @ 600 Ω
7	AF out (L) 60 mV @ 600 Ω
8	Ground

Note: Values for pins 2, 6, 7 are for a FM 3kHz deviation at antenna input level.

RACK MOUNT

There are four (4) screw holes (unused), two (2) on each side on the cabinet. They are provided for rack mount application. The thread size is M4 and subject to the application the **maximum screw length is 8mm. On no account should this length be exceeded.**

3 Connections

Connect your antenna to the connector labeled [ANT], and an external speaker, if required, to the connector labeled [EXT.SP]. The speaker should have a power handling capability of 2 Watts or greater.

Where possible, use the supplied AC/DC power unit. Connect the supplied power unit to the wall outlet and its DC cable to the [DC 12V] connector on the rear panel.

4 Power switch

To switch on the SR2000A, press once to latch the switch in.

4-1 Start-up

Connect the AC/DC power unit and switch on the power switch. The opening screen will briefly display the AOR logo, model number, firmware version and make a short [beep] sound. This start-up sequence is a factory default and cannot be altered.

4-2 Powering down

To switch off the SR2000A, press the power switch a second time, the switch releases and the unit is powered down. Interfering with the regular powering down process could damage the SR2000A.

5 Operation of the SR2000A

5-1 Display

This section explains what you can expect to see on the SR2000A monitor screen using the VFO mode in the spectrum operation mode.

Once the SR2000A is properly connected, a display typified by that shown below will appear on the screen.

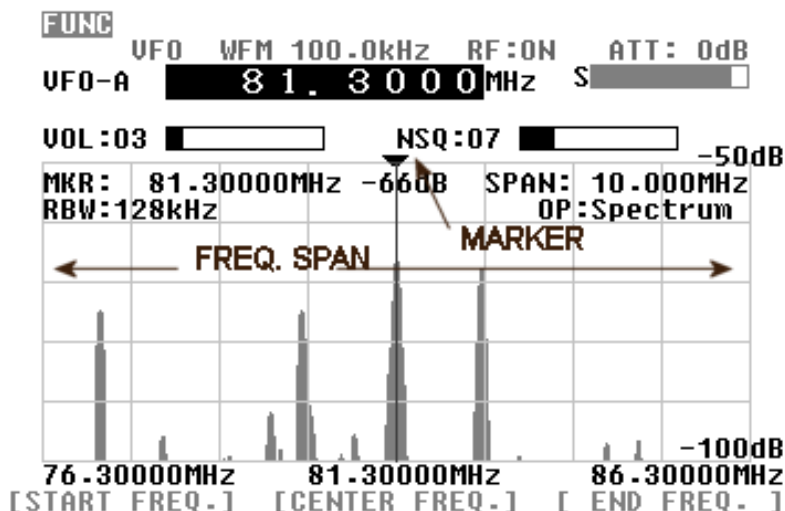

(1) Center Frequency (CF)

The center frequency reading is shown in MHz, and the highest resolution is 10 Hz.

(2) Total displayed bandwidth (SPAN)

The center frequency appears in the middle of the display with the frequency span extending to the left and right. The total frequency spread from the left through center to the right is referred as the total SPAN. The maximum span is 10 MHz and minimum is 0.160 MHz (160 kHz) in normal span mode. The horizontal scale is divided into 320 increments (steps).

WSP (Wide Span Mode)

The SR2000A displays up to 40 MHz of spectrum bandwidth (selectable between 20 MHz or 40 MHz) in the wide span mode. To select the wide span mode, set the SR2000A to the VFO mode, then press the **FUNC** key. A soft key menu will appear on the bottom of the LCD.

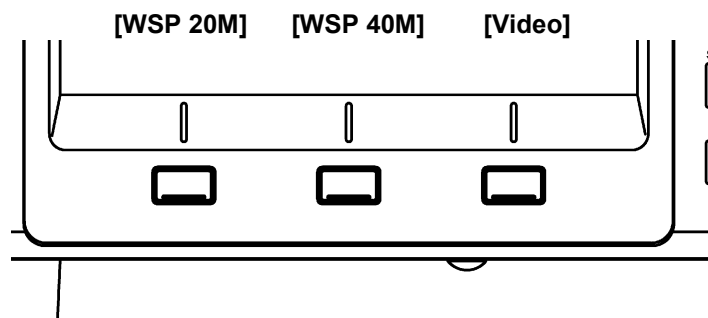

On this screen menu, choose either the **WSP 20M** (Span width 20 MHz) mode or the **WSP 40M** (Span width 40 MHz) mode.

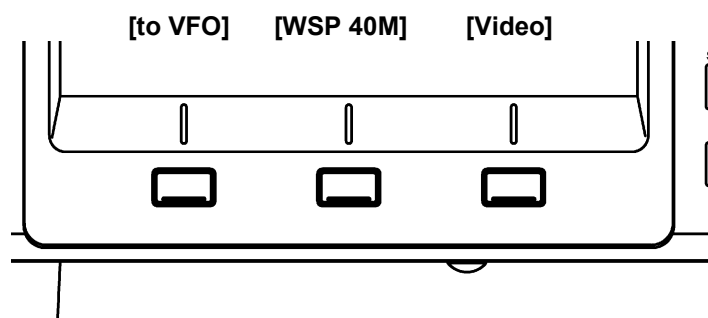

If you wish to monitor any of the signals displayed, put the cursor over the desired signal. Press the function key to display the WSP menu and press the **to VFO** soft key. The center frequency in the WSP mode is transferred to the VFO mode screen. Otherwise, press the **FUNC** key, then press the **4 (VFO)** key. The center frequency previously used in the VFO mode will be recalled.

(No audio is available when the frequency span is set to 20 MHz or 40 MHz)

To return to the normal span mode, press the **FUNC** key again. The soft key menu will be changed back to the standard VFO spectrum display.

(3) Start Frequency (SF)

The frequency displayed at the bottom left of the screen is the **Start Frequency** of the SPAN.

(4) Center Frequency (CF)

The frequency displayed in the center of the screen is the **center frequency** of the SPAN

(5) End Frequency (EF)

The frequency displayed on the right bottom of the screen is the **End (Stop) Frequency** of the SPAN.

Pressing the soft key underneath the legend and entering the frequency of your choice using the keypad can alter any of these frequencies. The other frequencies will automatically alter to fall in line with the allotted SPAN.

(6) Receive Mode

The receive mode is displayed at the top left hand side of the LCD screen and shows the current operation mode such as VFO mode, Memory Read, Memory Scan, Search, and FFT Search.

(7) Receiver Information (RFU)

The RFU information is displayed on the top of the LCD screen, and displays the Monitored frequency, receive mode, frequency step size, signal strength, RF amplifier status and attenuator level.

(8) Operating Mode (OBS)

Three operating modes for frequency display are available with the SR2000A:

- **Spectrum:** Spectrum Analyzer mode
- **StepReso:** Step Resolution mode
- **Channel:** Channel Scope mode (operates only in the VFO mode)

(9) Resolution Band Width (RBW)

Displays the current resolution in kHz. The resolution is selectable from 1 kHz, 4 kHz, 32 kHz, 64 kHz, and 128 kHz. Greater detail is obtained by selecting 4 kHz, often with a lower baseline while 128 kHz provides faster refresh rates. Note: If the spectrum frequency span is set between 160 ~ 422 kHz, the RBW is automatically displayed in 4 kHz. The RBW is not selectable in the WSP mode. (4 kHz fixed)

(10) MARKER

(11) Marker Information

The frequency and strength of signals may be read on the screen. Under the Marker menu the peak signal search is also available.

(12) Volume Level (VOL)

Volume level indicator represents the audio output level through the internal speaker, rear panel external speaker jack or headphones jack. While this icon is highlighted, the volume level can be adjusted from 0 to 72 (maximum). Beware of excessive volume levels when using headphones.

(13) NSQ/LSQ

Displays the squelch setup. **NSQ** stands for **Noise Squelch** and **LSQ** for **Level Squelch**. Levels range from 0 to 72.

(14) Signal level indicator

Received frequencies are plotted on the horizontal scale and signal strength on the vertical scale, showing the overall effect of signal activity over the given frequency span. The bottom horizontal line is the 'baseline'. When signals are entered, they produce vertical lines, and the higher the line, the stronger the signal. A 50 dB range is provided by the scale which is divided into 10 dB increments. The vertical scale is adjustable in six levels by altering the internal amplifier (amplitude). The horizontal scale is split into ten segments indicating the frequency span (bandwidth) in use. The marker is designed to move across one segment by one full rotation of the dial knob.

(15) Function Key Indicator

When the function key is pressed followed by certain keys, they serve a secondary function. The secondary function is printed above the respective key. While the function key is pressed, the reversed **FUNC** icon appears on the top left corner of the screen.

(16) VFO (Variable Frequency Oscillator)

The SR2000A has a nine (9) VFO system, identified as **VFO-A** to **VFO-I**. The example shown on page 9 is **VFO-A**.

Note: Relationship between Frequency Span and Frequency Step

The LCD provides a high resolution of 320 steps from the left to right edges of the screen X-axis. A frequency bandwidth represented by one step is calculated as $SPAN/320$. This is done automatically by the SR2000A in the Spectrum Analyzer and Step Resolution Modes. This bandwidth differs from the frequency step size displayed in the Receiver Information (RFU).

Resolution Bandwidth (RBW)

The resolution is selectable from 1 kHz, 4 kHz, 32 kHz, 64 kHz, and 128 kHz. Greater detail is obtained by selecting 1 kHz, often with a lower baseline while 128 kHz provides faster refresh rates.

5-2 Key Commands

The SR2000A allows user-friendly operation through 20 main keys, 3 basic operation keys and 3 soft keys. The selected functions are displayed on the LCD screen. The table below describes the functions allocated to each of the main keys and the basic operation keys.

KEYS	FUNCTIONS
Numeric keys 0 to 9 and decimal point	Frequency entry and any entry of any numeric value required.
FUNC+1	[FFT] FFT Search
FUNC+2	[SRCH] search mode
FUNC+2 (press & hold)	[SRCH] search bank input, settings
FUNC+3	[SCAN] memory channel mode, memory scan
FUCN+3 (press & hold)	[SCAN] memory channel input, settings
FUNC+4	[VFO] VFO mode, VFO switch
FUNC+5	[S SCAN] select scan
FUNC+6	[S SET] select memory set
FUNC+7	[PRIO] monitoring priorities
FUNC+7 (press & hold)	[PRIO] monitoring priorities settings
FUNC+8	[DEL] deletion of memory channels and search banks
FUNC+9	[CONFIG] SR2000A's overall configuration
FUNC+. [Decimal point]	[OFFSET] monitoring offset settings
FUNC+. [decimal point](Press & hold)	[OFFSET] frequency settings
FUNC+0	[OBS] operation mode selection
MODE	[MODE] receiving mode selection
FUNC+MODE	[PASS] pass frequency settings
FUNC+MODE (press & hold)	[PASS] pass frequency browser (CLR to exit)
STEP	[STEP] step frequency settings
FUNC+STEP	[SPN/STP] frequency span, frequency step settings
ATT (press and hold)	[ATT] attenuator settings on/off
FUNC+ATT	[WATER] waterfall display
RBW	[RBW] resolution bandwidth input
FUNC+RBW	[OPE] calculation function
CLR	[CLR] clear, back space key
FUNC+CLR	[A CLR] all clear, erase a sequence
MK.F	[MK.F] marker selection, CF settings
FUNC+MK.F	[MKR] marker mode selection
kHz	[kHz] to enter a frequency in kHz
FUNC+ kHz	[AMP] amplifier settings
MHz	[MHz] to enter a frequency in MHz, [enter] key
MHz (press & hold)	Input to memory channel
VOL/MUTE	Select the dial as a volume knob
VOL/MUTE (press & hold)	Mute the audio
FUNC+ VOL/MUTE	Mute the audio
SQUELCH / MONI	Select the dial as a squelch knob
SQUELCH / MONI (press & hold)	Open the squelch
FUNC + SQUELCH / MONI	Open the squelch
FREQ. / MKR	Select the dial as a frequency tuning knob
FREQ. / MKR (press & hold)	Select the dial as a marker tuning knob
FUNC+WSP 20M (Soft key)	Select 20MHz of spectrum bandwidth
FUNC+WSP 40M (Soft key)	Select 40MHz of spectrum bandwidth
FUNC+ Video (Soft key)	Select the video display mode

6 Monitoring Modes

6-1 Basic operations VFO mode (manual mode)

This describes the SR2000A in the most commonly used VFO mode. This mode allows manual input of the center frequency.

6-1-1 Setting up the monitoring frequency

The SR2000A follows the rule:

$$\textit{Monitor main frequency (MF) = Center Frequency (CF)}$$

In the **Spectrum Analyzer** or **Step Resolution modes**, you can enter the frequency directly through the numeric keypad, followed by the **MHz** key to complete the sequence.

In addition, the receiver may be tuned using the dial knob. In the plot below (with the frequency selected frequency shown in reverse contrast), the frequency will tune in the step size shown by 'step frequency', in this case 100 kHz.

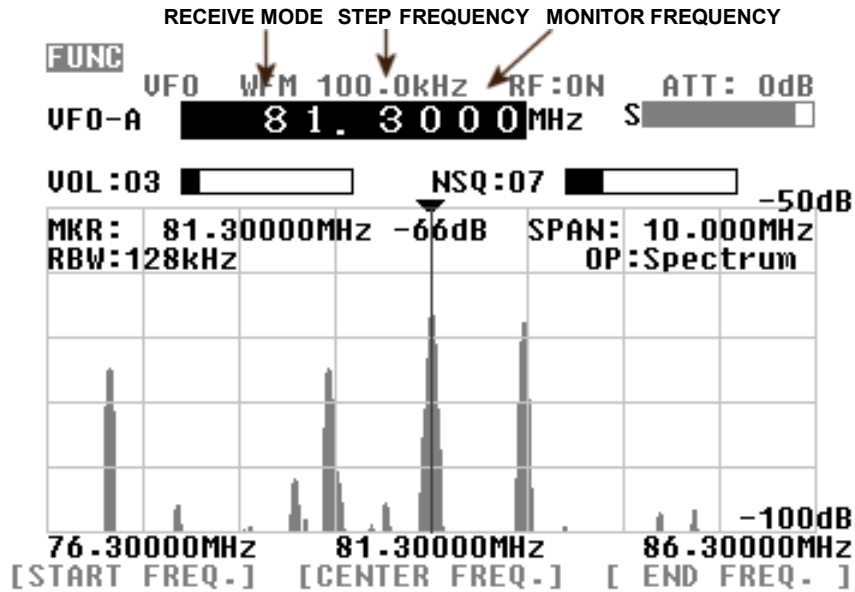

By pressing the soft key below **CENTER FREQ.** on the LCD, the center frequency is selected and can be changed using the keypad.



Key entry of the main frequency:

Enter the frequency in MHz format using the numeric keys, then press the **MHz** key to complete.

Frequency Step:

Once the frequency on the LCD is selected (frequency displayed in reverse contrast), the frequency step that applies is the receiver tuning frequency step shown in the above example as 100.00 kHz This can be changed by pressing the step key and rotating the tuning dial

The display step is only shown in step resolution mode
 In the plot shown above, the display frequency step would be 31.250 kHz. (10 MHz/320=31.250 kHz)
 This value is not displayed in the Spectrum Analyzer mode or channel mode only in step resolution mode
 In the example below the **Step Resolution mode** is active. The display step can now be set by pressing FUNC followed by STEP and the display step keyed in using the keypad.

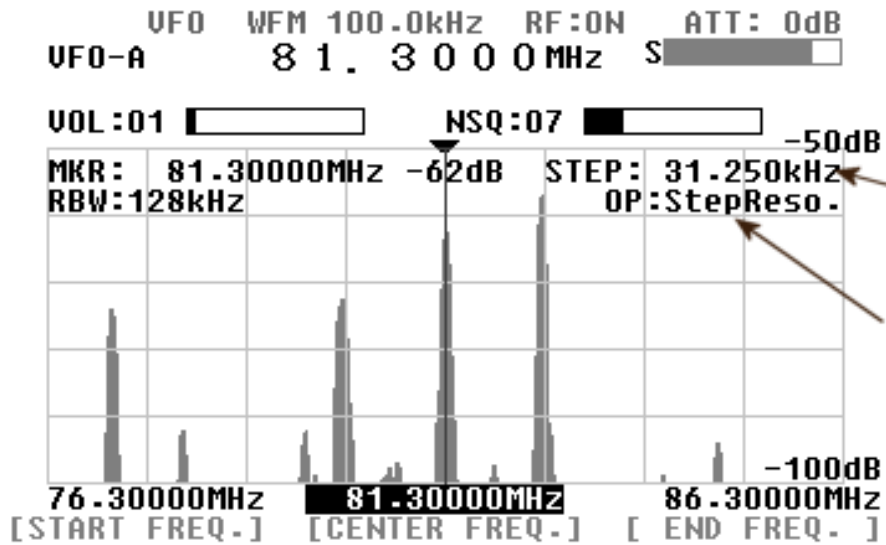

Press the **FREQ** key to reassign the frequency control to the dial knob.

Start and End Frequency Input

In the VFO mode, the step key enables the step size for tuning the receiver to be customized. Pressing the **STEP** key will select the tuning step in reverse contrast. Then rotate the dial to select a new step size. To confirm the entry, press the **MHz** key.

There are 13 preprogrammed step sizes as follows:

0.1, 0.5, 1.0, 2.0, 5.0, 6.25, 8.33, 9.0, 10.0, 12.5, 25.0, 50.0, and 100.0 kHz.

In addition, unusual step sizes may be entered by using the numeric keypad in 0.1 kHz increments. Acceptable input range is 0.1 kHz to 100 kHz.



To enter the main frequency:

Press the **FREQ** key which will display the frequency in reverse contrast. You can then tune the receiver using the tuning knob.

To enter the receiver tuning step, press the **STEP** key. Rotate the dial knob to

select the desired tuning step, and press the **MHz** key.

You may also enter the step frequency by the numeric keypad and press the **MHz** key.

6-1-2 Setting up the receive mode

To change the receive mode, press the **MODE** key. The receive mode icon will be selected (in reverse contrast) on the LCD to confirm that the mode select menu has been activated. The following 4 modes are available with the SR2000A: NFM, WFM, SFM, AM.

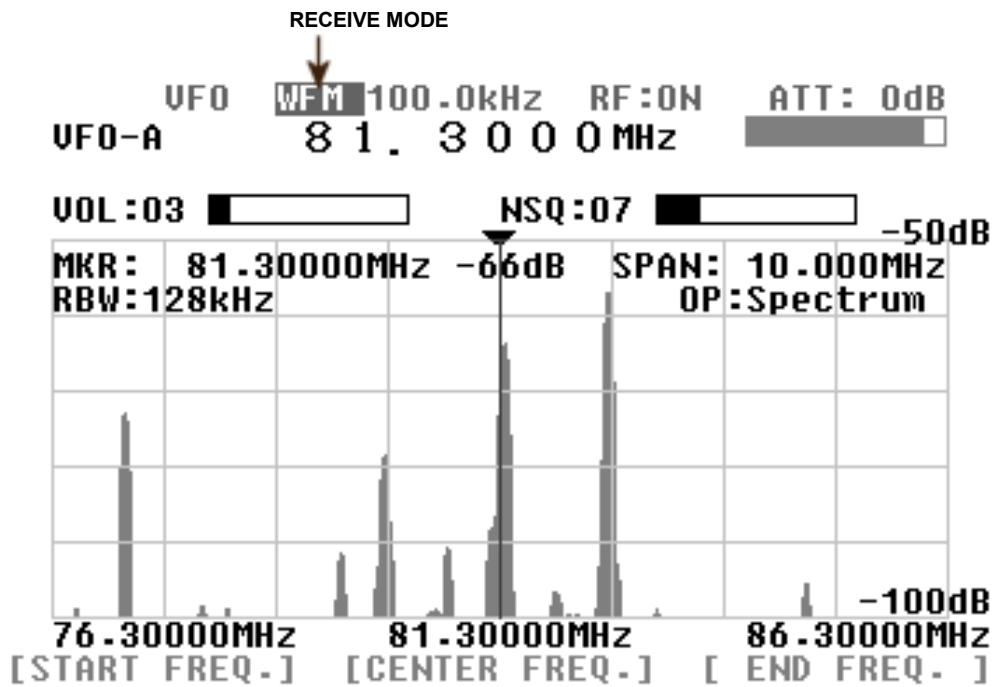

Receive mode setup:

- Press the **MODE** key.
- Rotate the dial knob to select the desired mode.
- Press the **MHz** key.

IF filter bandwidth for each receiving mode

RECEIVE MODE	IF filter bandwidth
WFM	300 kHz
NFM	15 kHz
SFM	6 kHz
AM	6 kHz

When an optional APCO25 (P25) board is installed, select the **NFM** mode to monitor APCO25 (P25) signal in conventional mode.

6-1-3 Audio Gain Control

Pushing the **VOL** key will select the volume indicator on the LCD (in reverse contrast). You can then adjust the AF gain by rotating the dial knob.

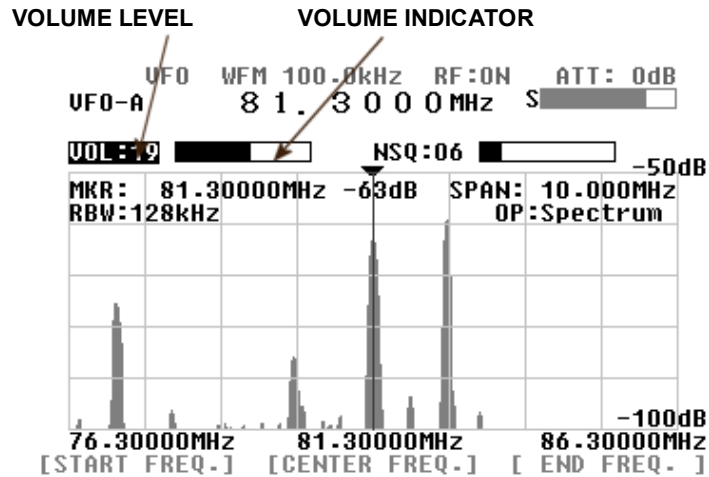

AF gain (volume level) control:

Press the **VOLUME** key.
 Rotate the dial knob to select the desired volume level.
 The volume level can be set from level 00 to 72.

To mute the sound, press the **FUNC** key, then press the **VOL** key.
 (Press and hold the **VOL** key for one second will do the same.)

To undo the mute, repeat the above steps.

6-1-4 Squelch control

The SR2000A has two (2) squelch types, **NSQ** (Noise Squelch) and **LSQ** (Level Squelch). Pressing the **SQUELCH** key allows you to select one or the other. Then adjust the squelch level with the dial knob, from level 00 to 72.

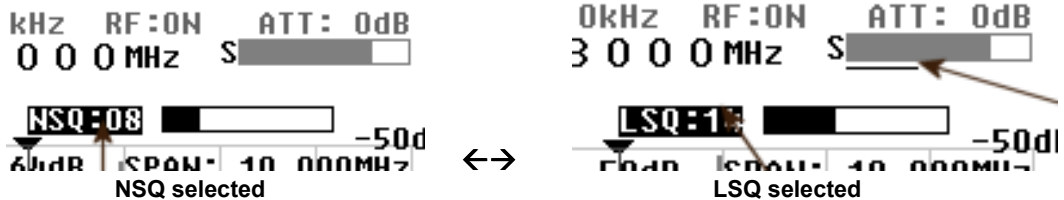

Note

In both squelch modes, an [S] icon appears on the left side of the S-meter when the squelch is open.

[Note] When LSQ is selected, a white line under the S-meter represents the squelch level compared to signal strength.



Squelch level control:

Press the **SQUELCH** key.
Rotate the dial knob to select the desired level.
The squelch level can be set from level 00 to 72.

6-1-5 RF attenuator and preamplifier settings

The **ATT** key selects the antenna attenuation level (by reverse contrast). Using the dial knob, you can choose between 0 dB, 10 dB, 20 dB. Validate your choice by pushing the **MHz** key.

The RF preamplifier can be toggled on and off by pressing the **ATT** key for one second. The change is reflected on the screen by **RF:ON** and **RF:OFF**.



Change the RF attenuator settings:

Press the **ATT** key.
Rotate the dial knob to select the desired setting.
Press the **MHz** key to validate the entry.

Depending on the attenuator setting, general noise floor level on the display may increase.

To toggle the RF amplifier on and off, press and hold the **ATT** key for one second.

6-1-6 Mute volume and open squelch (monitor)

Muting the AF output can be done in two ways. Either by pressing the **FUNC** key followed by the **VOL** key, or pressing the **VOL** key for one second. In both cases, the volume level display turns red to indicate that the sound is muted. To undo the mute, repeat the same steps.

The squelch can also be opened to monitor the signal by pressing the **FUNC** key followed by the **SQUELCH** key, or pressing the **SQUELCH** key for one second. To show the squelch is temporarily opened the squelch display is shown in red.



To mute the volume:

Press the **FUNC** key, then press the **VOL** key. Or, press and hold the **VOL** key for one second.

To open the squelch for monitoring:

Press the **FUNC** key, then press the **SQUELCH** key. Or, Press and hold the **SQUELCH** key for one second.

6-1-7 Input sensitivity (amplitude)

This feature refers to the setup of the input sensitivity reference level of the SR2000A spectrum display. There are 6 different levels of input sensitivity between 0 dBm and -50 dBm in 10 dB steps. You will see that the screen is marked out in 10 dB divisions so that setting an [AMP] level of -50 dB means that you are setting a base line sensitivity of -10 dB. Press the **FUNC** key, then press the kHz key to highlight the reference level (in reverse contrast). Either adjust the level with the dial knob and validate with the MHz key, or enter the value with the numeric keys as in the example below for a reference level of -30 dBm.

FUNC + kHz
3
MHz

You may ignore zeros [0] following the 3 in this example.

Any invalid entry will generate a beep, and the nearest value will be automatically selected instead.

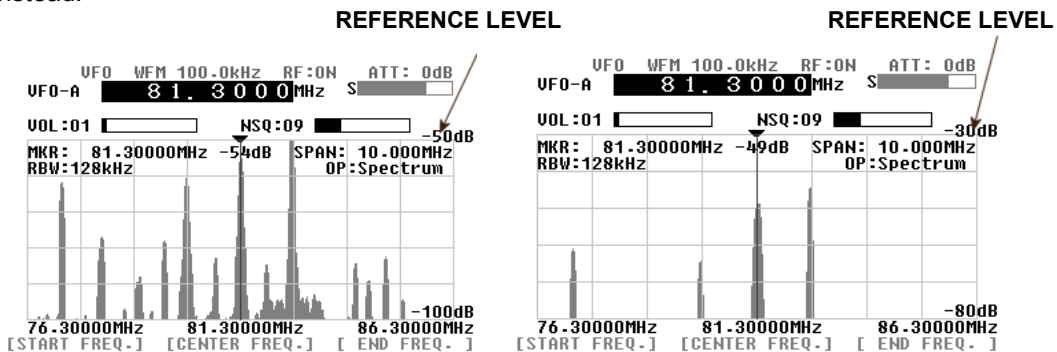

OBSERVATION WITH DIFFERENT AMPLITUDES

6-1-8 Resolution bandwidth (RBW)

The sampling filters may be selected from four (4) different bandwidths of 1 kHz, 4 kHz, 32 kHz, 64 kHz and 128 kHz.

Press the **RBW** key to make the RBW display appear in reverse contrast. Rotate the dial knob to select the desired value followed by **MHz** key to complete the sequence.

The two plots here show the results from monitoring the same signal (81.3 MHz WFM) but using 4 kHz and 128 kHz RBW bandwidth respectively. With narrower RBW, finer signal activity can be observed. With wider RBW bandwidth, the resolution becomes coarse but it can be better suited for signals with wide bandwidth such as FM broadcast signals.

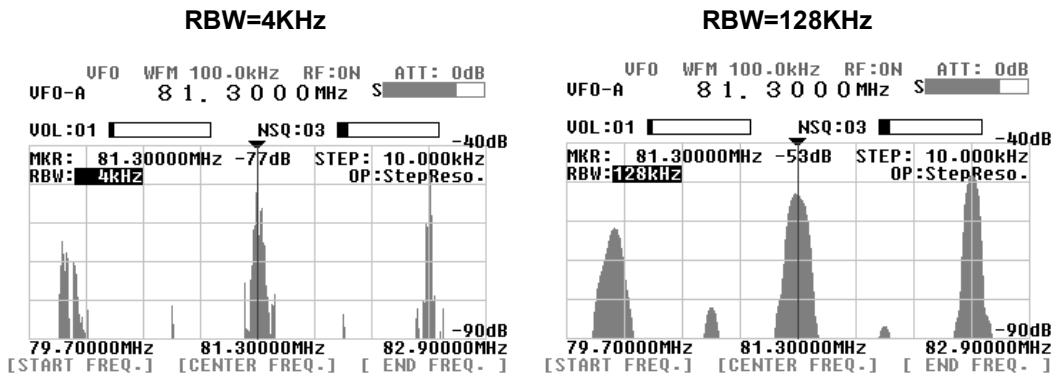

Set up the RBW (Resolution Band Width):

- Press the **RBW** key.
- Rotate the dial knob to select the desired RBW.
- Press the **MHz** key to validate.

The RBW should be chosen as appropriate for different monitoring requirements. As the SR2000A employs modern DSP/FFT techniques, there is no difference in screen update speed regardless of which RBW has been selected. However, selection of RBW may affect displayed signal strength.

When a signal is displayed which is much wider in bandwidth than the currently selected RBW filter (for example, WFM or digital transmissions), there will be some inaccuracy in the signal strength displayed. This is because the wider signal will lose some of its energy after passing through a narrower RBW filter.

6-1-9 Waterfall display function

The SR2000A is equipped with a waterfall function that can display the variation of signal strengths in conjunction with the time lapsed (as sweeps progress). Sixteen different colors are employed dependent on signal strength, in the shape of waterfall.

Press the **FUNC** key, then press the **ATT** key to start the waterfall display. To exit the waterfall display, repeat above steps or press the **CLR** key.

Note that this function can be used in the VFO mode, memory read mode, and WSP modes.

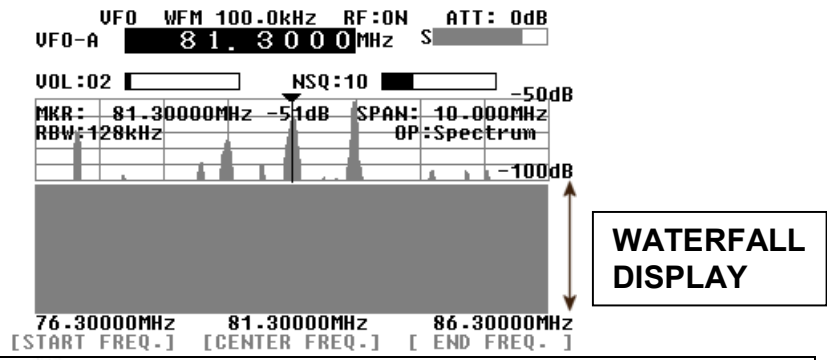

Activate the waterfall function:

Press the **FUNC** key, then press the **ATT** key.

Signal strength corresponds to the height of each signal in the vertical scale. Therefore, the color will vary when the input sensitivity (amplitude) has been altered in the course of monitoring.

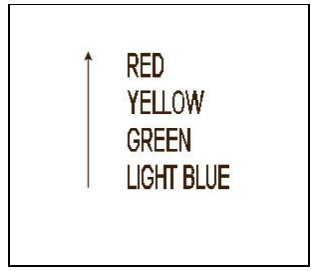

Waterfall color corresponds to the vertical height.
Signal display is scrolling downwards as time progresses.

6-1-10 Selecting the operation modes

The SR2000A has 3 different operation modes that can be selected by pressing the **FUNC** key followed by the **0** key. The soft keys below the screen give you access to each corresponding mode. The channel scope mode is only available in the VFO seek mode.



Select the operation mode menu:

Press the **FUNC** key, then press the **0** key.
Then select one of the three modes by pressing the corresponding soft key.

Operation modes:

1. Spectrum analyzer mode (**Spectrum**)
2. Step resolution mode (**StepReso**)
3. Channel scope mode (**Channel**)

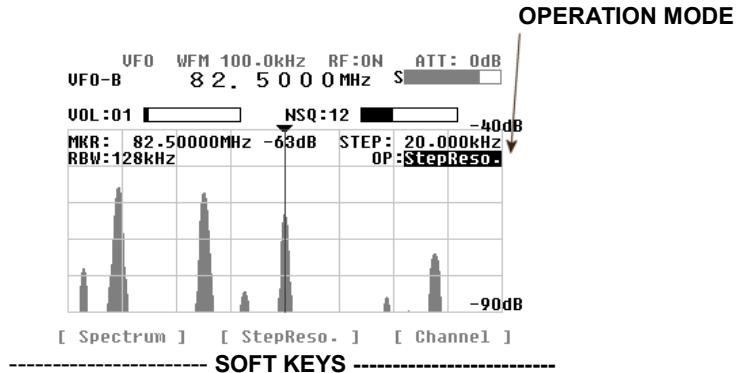

6-2 Operation Modes

There are three (3) operation modes with your SR2000A. They are the **Spectrum Analyzer Mode**, **Step Resolution Mode**, and the **Channel Scope Mode**.

To go to the **Spectrum Analyzer Mode**, press the **FUNC** key, then press the **0** key. Then press the **Spectrum** key on the soft keys.

To go to the **Step Resolution Mode**, press the **FUNC** key, then press the **0** key. Then press the **StepReso** key on the soft keys.

To go to the **Channel Scope Mode**, press the **FUNC** key, then press the **0** key. Then press the **Channel** key on the soft keys.

6-2-1 Spectrum analyzer mode

The plot below shows the following signal data:

Center frequency (CF).....	84.0 MHz
Frequency span.....	10.0 MHz
Start frequency	79.0 MHz
End frequency.....	89.0 MHz
Step bandwidth.....	31.25 kHz (the step bandwidth is not displayed)

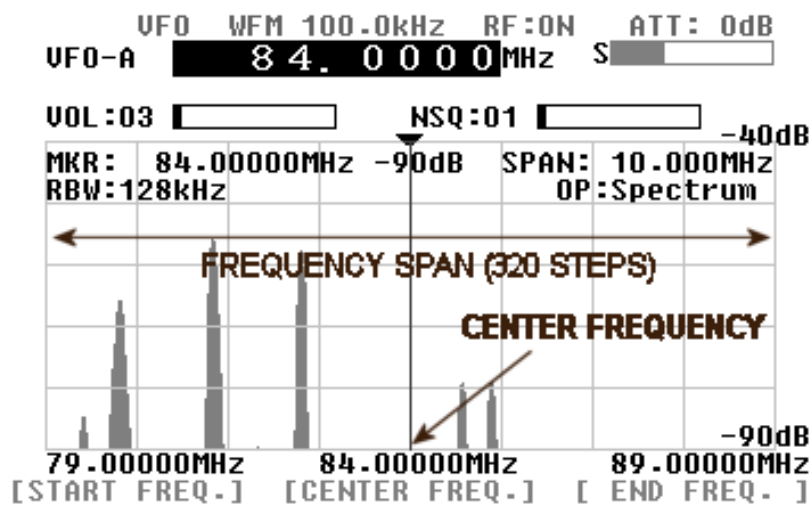

In this example, one step represents a bandwidth of 31.25 kHz.
 (10MHz / 320 = 31.25 kHz)

- **Center frequency (CF)**

Press the **CENTER FREQ.** soft key to make the center display readout appear in the reverse contrast. Enter a desired frequency via the numeric keys followed by the **MHz** key. This becomes the center frequency.

- **Frequency span (SPAN)**

Press the **FUNC** key, then press the **STEP** key to reverse the contrast of the **SPAN** numeric display. Enter the frequency span over which you wish to monitor, using the numeric keys followed by the **kHz** key or the **MHz** key to confirm the entry. The display step will be automatically calculated but the value is not displayed on the LCD.

- **Start and End frequencies**

The START and End frequency can be entered in the same manner as the center frequency entry using the assigned soft keys, numeric keys and **MHz** key. The dial knob is not valid for the entry.

[Note]

The CF = MF principle

In the spectrum analyzer mode and the step resolution mode,

Main frequency = Center frequency

When the center frequency is altered using the numeric keys or the dial knob, the main frequency is changed accordingly. The center frequency becomes the main frequency.

Step bandwidth

In the spectrum analyzer mode, the bandwidth value per step is not displayed on the LCD.

Displayed frequency span (MHz) is obtained by the following formula:

CF +/- (frequency span / 2)

In the above example, the center frequency is 84.0 MHz, therefore, the display frequency span is $84 \pm (10 / 2) = 84 \text{ MHz} \pm 5 \text{ MHz}$.

6-2-2 Step resolution mode

The plot below shows the following signal data:

Center frequency (CF)...	122.50 MHz
Step bandwidth.....	25.0 kHz
Start frequency	118.5 MHz
End frequency.....	126.5 MHz
Frequency span.....	8 MHz

The frequency span value is automatically calculated by the display step, however, it does not appear on the screen.

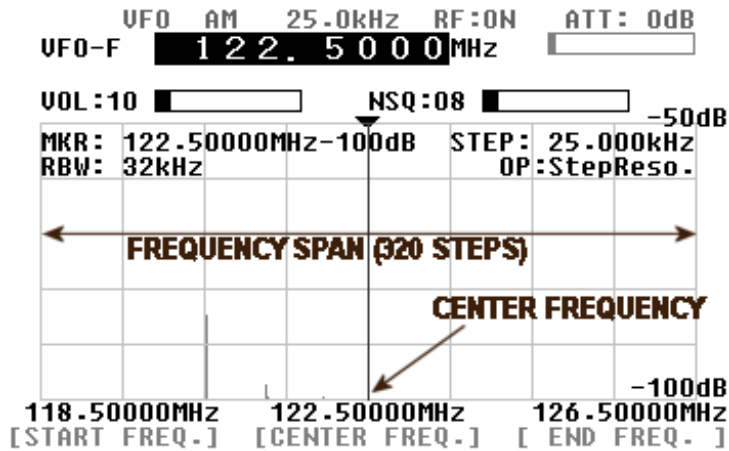

In this example, the chosen step is 25 kHz, the frequency span is 25 kHz x 320 = 8 MHz.

[Note] When the center frequency (CF) is selected and controlled with the dial knob, the monitor main frequency (MF) stays the same on display. In this case, MF is **NOT** equal to CF.

Effective frequency coverage

The center frequency (CF) must be within the frequency coverage of the SR2000A (25 MHz ~3000 MHz). If exceeded, monitoring is not possible.

Display frequency span (MHz) is obtained by the following formula:

$$\text{CF} \pm (\text{display step} \times 160)$$

In the above example, the center frequency is 122.50MHz. Therefore, $122.5 \pm (25 \times 160) = 122.5 \text{ MHz} \pm 4 \text{ MHz}$

6-2-3 Channel scope mode

The plot below shows the following signal data:

Start frequency.....	82.0 MHz
Display step.....	20.0 kHz
End frequency.....	85.2 MHz
Frequency span.....	3.2 MHz
Main frequency marker.....	84.0 MHz

In this mode, the center frequency value does not appear on the screen.

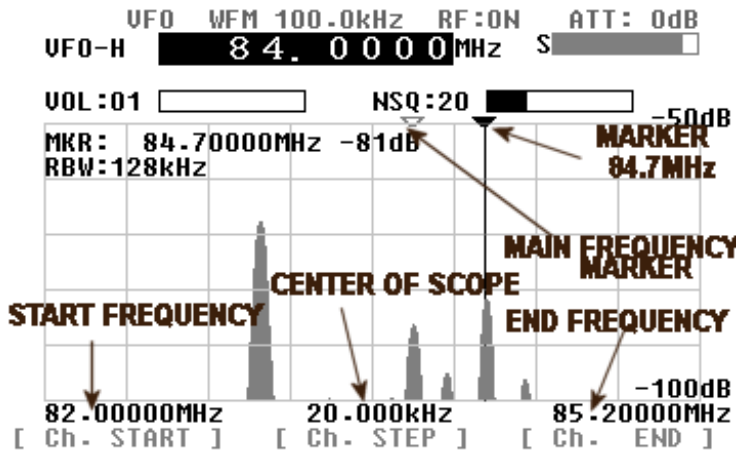

- **Start frequency (Ch. START)**

Press the **CH. START** soft key (left key below the LCD) to make the start frequency display appear in reverse contrast. Enter a desired frequency using the numeric keys, which is the lowest of the frequency spread you wish to monitor, followed by the **MHz** key to confirm.

- **Step frequency (Ch. STEP)**

Press the **CH. STEP** soft key (middle key below the LCD) to make the frequency display appear in reverse contrast. Enter the desired step frequency using the numeric keys, followed by the **kHz** or the **MHz** key to confirm.

- **End frequency (Ch. END)**

Press the **Ch. END** soft key (right key below the LCD) to make the end frequency display appear in reverse contrast. Enter the desired frequency using the numeric keys. This is the highest frequency of the spectrum you wish to monitor, followed by the **MHz** key to confirm.

- **Marker and main frequency marker operation**

When the channel scope mode is activated, monitoring begins on the start frequency. Presses the **FUNC** key followed by the **FREQ.** key and rotate the dial knob to move the white marker onto the signal of your interest, and then press the **MK.F** key. The yellow receive marker moves to the nominated position and the SR2000A monitors the selected frequency.

[Note]

The channel scope mode functions only in the VFO mode. Moreover, if the VFO is switched, setting information will be lost and the operation mode will change to spectrum analyzer mode

The **end frequency (Ch. END)** is confined by the following formula:

$$\begin{aligned} &(\text{Ch. START}) + [(\text{Ch. STEP}) \times 160] \text{ or,} \\ &(\text{Ch. START}) + 5 \text{ MHz} \quad \text{or,} \\ &(\text{Ch. START}) + > 0.16 \text{ MHz} \end{aligned}$$

For this reason, if you do not enter an end frequency, the SR2000A will automatically select an appropriate end point.

Invalid entry for the end frequency will be alerted with a beep and the closest possible valid frequency will be automatically chosen by the SR2000A. The same happens with any invalid frequency entry.

6-3 Marker functions

The SR2000A has a marker function. The marker is often used to obtain the value of a frequency of interest. In addition to the instantaneous reading, it provides peak detection and continuous peak detection. Press the **FUNC** key followed by the **MK.F** key to place the SR2000A in marker mode operation.

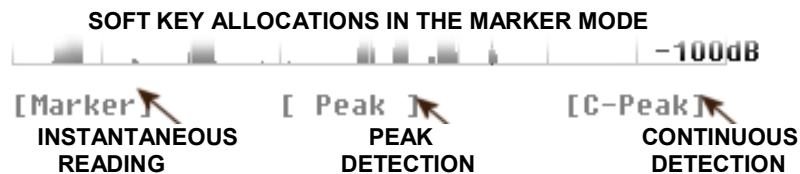

The marker function operates in the WSP mode and the memory channel mode (except MK.F mode).

- **Instantaneous reading (Marker: MKR)**

This feature is useful for many applications. The marker can be moved sideways by rotating the dial knob. The LCD displays the frequency and signal strength reading where the marker is positioned.

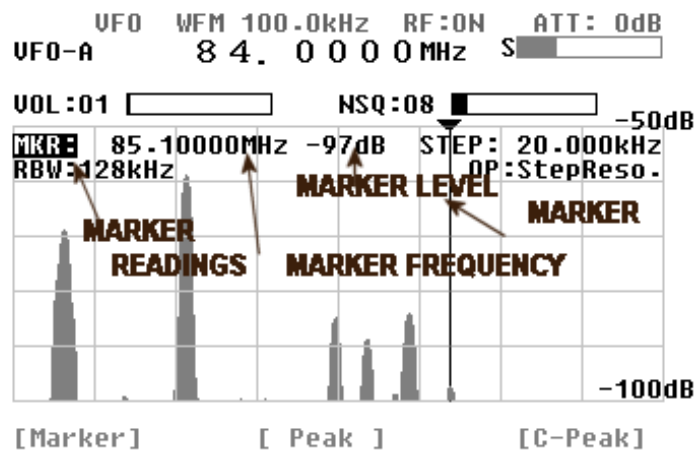

- **Peak detection (Peak: PEK)**

This feature is used to detect the most powerful signal while sweeping the frequency range. Press the **PEAK** soft key, which in turn requests a trigger level. You need to specify what level is required. Enter the trigger level via the numeric keys. Only signals that are stronger than the trigger level you specified will then be subject to peak detection. The marker will be forced to the position of the strongest signal detected and end its sweep sequence.

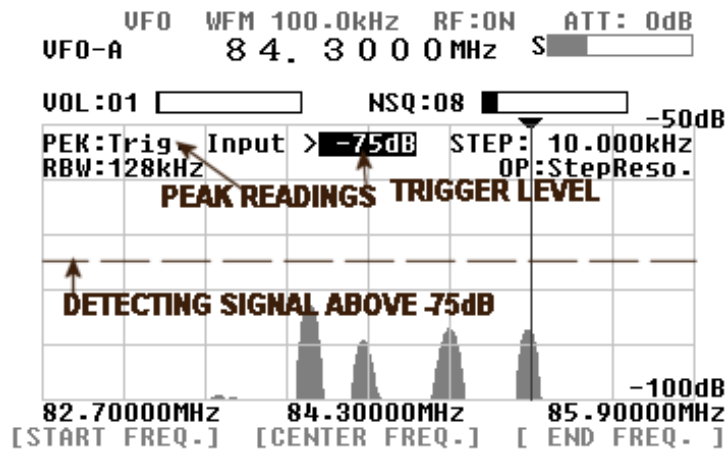

While no signal above the trigger level is received, the TRIG. WAIT is displayed.

- **Continuous peak detection (C-PEAK: CPK)**

This function is designed to continue the peak signal detection process one sweep after another.

Press the **C-Peak** soft key to activate the function.

There is no trigger level setup in this process.

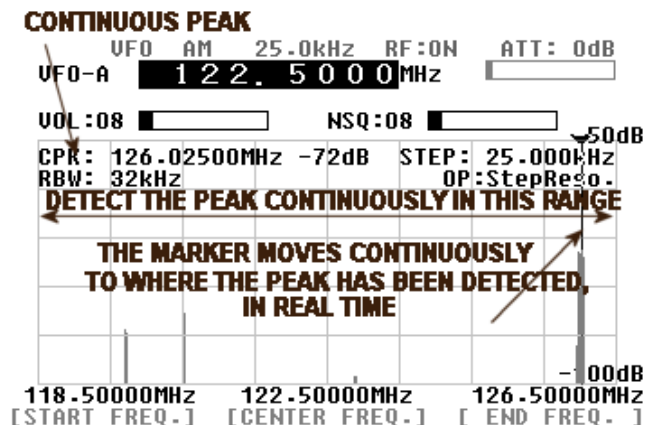

[Note]

[MK.F] key functions:

Pressing the **MK.F** key once enables the marker to be tuned independently of the VFO frequency, then pressing the key again makes the marker frequency the center frequency and enables reception of that frequency.

6-4 Calculation function

Pressing the **FUNC** key followed by the **RBW** key allows you access to three (3) calculation features: Maximum value hold (**MAX**), Average value (**AVR**) and Median (**MED**) value. Each function is then accessible through the corresponding soft key below the LCD. Note: This function is also available in the WSP mode and the memory channel mode.

- **Maximum value hold (MAX)**

Press the **MAX** soft key to access this feature, and the **MAX** icon will be displayed. To exit from this feature, press the **FUNC** key, then press the **RBW** key, and press the **MAX** key.

With the MAX function in use, each sweep will be retained as data and build-up until the process ends. This is particularly useful to detect intermittent signals that come and go over a period of time.

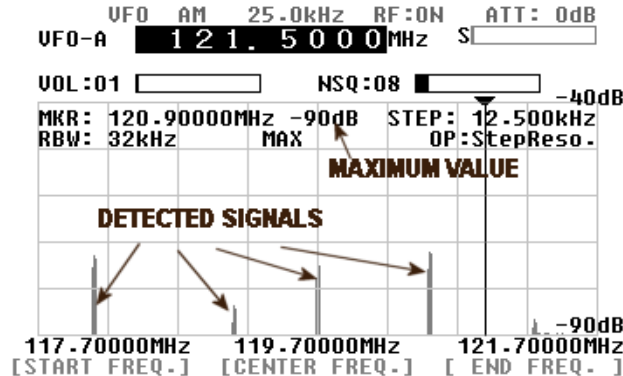

- **Averaged value (AVR range: 2 ~ 31)**

Press the **AVR** soft key to access this feature: the **AVR** icon will be displayed. You are required to enter a sampling cycle between 2 and 31 to produce averaged results.

To exit from this feature, press the **FUNC** key, then press the **RBW** key, and press the **AVR** key.

This feature is designed to provide a plot pattern obtained by averaging the signals received over the sampling cycle. A stable signal pattern is produced even if the signal is fluctuating in strength.

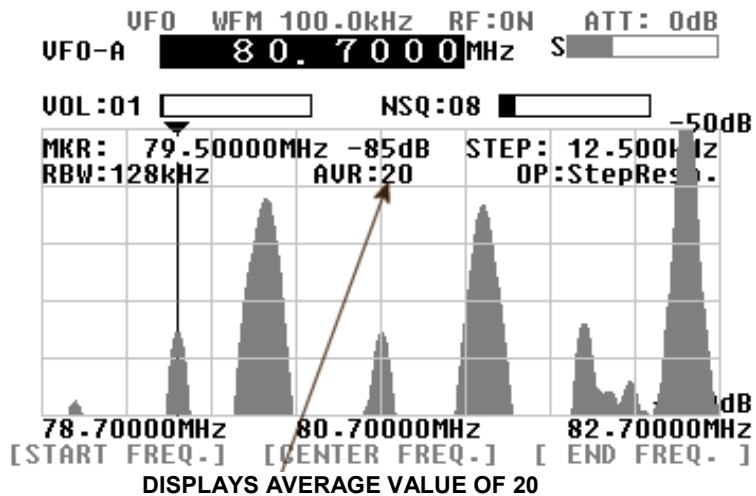

- **Median (MED range: 2 ~ 4)**

Press the **MED** soft key to access this feature: the **MED** icon will be displayed. The plot is designed to provide signal pattern based over a sampling cycle of between 2 and 4, and is useful to plot impulse noise. The sampling cycle can be entered via the numeric keys followed by the **MHz** key.

To exit from this feature, press the **FUNC** key, then press the **RBW** key, and press the **MED** key.

[Example]

Display step: 10 kHz, Median: 2, and a frequency of 50 MHz:

$50 \text{ MHz} - 10 \text{ kHz} = 49990 \text{ kHz}$
$50 \text{ MHz} + 10 \text{ kHz} = 50010 \text{ kHz}$

The value showed on the dB axis at 50 MHz will be the average of the three values for the 3 frequencies.

6-5 Video monitor function

The SR2000A has a built-in video decoder and supports NTSC and PAL, format. The video signal format is automatically detected.

If the video signal frequency is below 1,000 MHz, then the AM video mode will be automatically selected.

If the video signal frequency is above 1,000 MHz, then the FM video mode will be automatically selected.

To activate the video function, perform the following steps:

1. In the VFO mode or the spectrum analyzer mode, set the **voice frequency** of the video signal.
2. Press the **FUNC** key.

3. A soft key menu will appear on the bottom of the LCD.

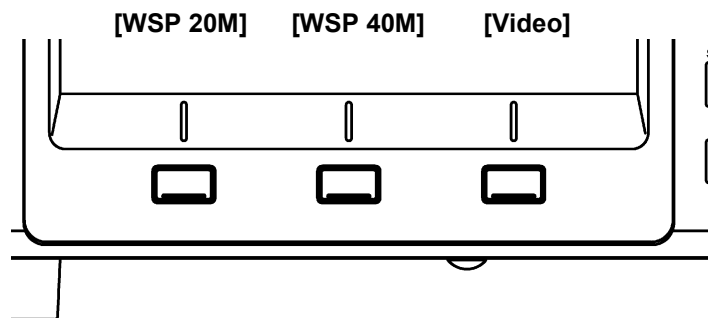

4. Press the **Video** soft key.

To return to the normal spectrum analyzer screen, push any soft key.

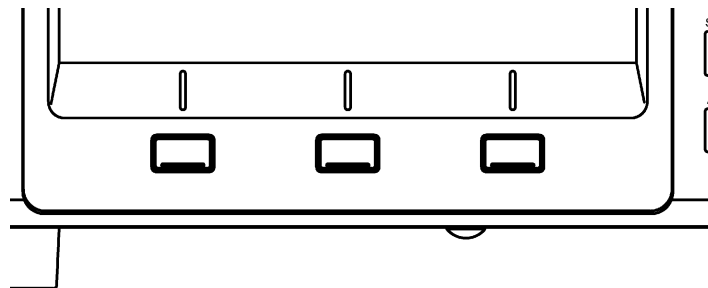

[Note] Some video transmitters utilize reversed frequency shift modulation in order to scramble the signal. In this case, the video signal can be descrambled by performing following steps:

1. In the configuration menu (see Chapter 7, Configuration), select the V.FREQ DIR.
2. Select NORMAL or REVERSE to descramble video signal.

7 Configuration

In this chapter, we learn how to set fundamental operating parameters of the SR2000A. To access the SR2000A's configuration menu, press the **FUNC** key, then press the **9** key.

VFO WFM 100.0kHz RF:ON ATT: ODB

 95. 7500 MHz

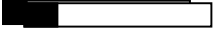
VOL : 07  NSQ : 20

RX CONFIGURATION

DELAY	TIME	2.0	BEEP	ON
FREE		OFF	PLOT	PAINT
MKR-OUT		OFF	DEF-DIAL	OFF
NTSC/PAL		PAL	DIAL-TIME	10
V.FREQ		AUDIO	DATA LINE	REMOTE2
V.FREQ DIR		NORMAL	DATA BPS	115k
V.H-POS		16	BACKLIGHT	ON
V.SYSTEM		PAL		

[UP] [DOWN]

Use the **UP** and **DOWN** soft key to move from one section to the other. Once the desired selection appears in reverse contrast, rotate the dial knob to do any changes as needed, and press the **MHz** key to go to the next section. Be aware that your changes have not been saved so far! Once you have finished the desired configuration changes, press and hold the **MHz** key for one second to save all your settings and return to the screen you were at before entering the configuration.

Press the **CLR** key to escape from the configuration menu without saving your changes. You will return to the screen you used before entering the configuration screen.



To access the configuration menu:

Press the **FUNC** key, then press the **9** key.

Use the **UP** and **DOWN** soft keys to go to the desired selection. Rotate the dial knob to apply changes.

To go to the **next selection**, press the **MHz** key.

To **save** your all changes, press and hold the **MHz** key for one second.

To **cancel** the configuration without saving any changes, press the **CLR** key.

- **DELAY TIME**

Sets the delay in seconds, between squelch closing and scan restart. Default setting is 2. Setting possibilities are [OFF] (scan resumes immediately), a range from 0.1 ~ 9.9, and HOLD (does not continue scan).

- **FREE**

Sets the delay in seconds, between the squelch opening and scan restart. Default setting is OFF. Setting possibilities are OFF and 0.1 ~ 9.9. This feature is rarely used and should be set to OFF.

- **MKR-OUT (Marker data output)**

The frequency and signal level which the marker is reading, can be output as data to the serial port. [ON] enables this feature. Default setting is [OFF].

- **NTSC/PAL**

Applies only if you want to see the SPECTRUM on an EXTERNAL monitor, depending on your monitor's video standard. Default setting is NTSC.

- **V. FREQ**

Select the audio frequency on the video signal to the monitor frequency or the audio signal frequency (video frequency – 2.645 MHz). Default setting is AUDIO.

If there is an adjacent interfering signal near the receive frequency and causes the decoding problem, then set it to AUDIO (video frequency – 2.645 MHz). In that case, select the V.FREQ DIR to NORMAL.

- **V.FREQ DIR**

Some video transmitters utilize the reversed frequency shift modulation in order to make signals scrambled. If the signal is reversed, select the V.FREQ DIR to REVERSE. Default setting is NORMAL.

In the AM video mode, select NORMAL.

- **V.H-POS**

This function is to adjust the horizontal position of the external video monitor. Default setting is 16.

- **V.SYSTEM**

Concerns the display of a video signal on the SR2000A internal screen. Default setting is AUTO, SR2000A should be able to detect the video standard automatically between NTSC and PAL. However, in some rare cases you might have to force the detection by selection NTSC or PAL manually.

Note: SR2000A is not applying any video conversion to the signal coming out of the [video out] connector.

- a NTSC video signal can only be viewed on a NTSC monitor
- a PAL video signal can only be viewed on a PAL monitor

- **BEEP**

The SR2000A emits confirmation [beeps] when the keypad is used. Default is ON. Beep level is not adjustable.

- **PLOT (Drawing mode setup)**

Set to PAINT as default. The OUTLINE setting has the monitor only drawing the outline of the displayed wave.

- **DEF-DIAL (Dial automatic return), DIAL-TIME (Dial return timing)**

The dial knob is used to tune 4 main functions which are frequency (FREQ), marker (MKR), Squelch (SQL) and AF gain (VOL). The DEF-DIAL selections allows you to set one of the four functions as the dial default, to which it returns after a given time. This time in seconds can be set with the DIAL-TIME selection, anywhere between 1 and 30 seconds. Default DEF-DIAL setting is OFF; the dial retains the functions you have assigned to it.

- **DATA LINE**

Select the PC interface port. Default setting is REMOTE 2 (RS-232C).

- **DATA BPS**

Used to configure the serial port speed. Following speeds are available:

9600, 19.2 k, 38.4 k, 57.6 k, 115 kbps. Default speed is 115 kbps.

- **BACKLIGHT**

Switches the LCD screen backlight on and off.

Caution: *Setting the LCD screen to off renders it unreadable, therefore, it is highly advisable to maintain the default in the ON position. The OFF feature is for professional use of the SR2000A.*

[Note]: While accessing the SR2000A configuration menu, the only receiving functions that can be altered are the AF GAIN (volume) and SQUELCH. To adjust these levels first press the appropriate key. To return to the configuration menu, press the **FREQ.** key,

7-1 Resetting the SR2000A

If you wish the SR2000A to return to the factory default settings, perform the following steps:

1. Turn the SR2000A power off.
2. Press and hold the [3] key and [6] key simultaneously while turning the power on.
3. After releasing the keys the SR2000A goes through it's normal initialization boot sequence but displays the word RESET in addition to the initialization message,

8 Memory Channels

The SR2000A features 1000 memory channels (100 channels in each of the 10 banks). Press the **FUNC** key, then press the **3** key to access the [Memory read] mode.

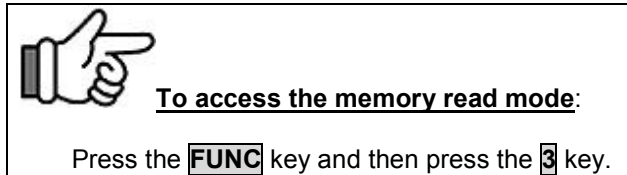

8-1 Memory read mode

Once you enter the [memory read] mode, the screen looks like the plot below. Be aware that you cannot enter this mode unless at least one frequency has previously been stored as a memory channel (as described in paragraph 8-3).

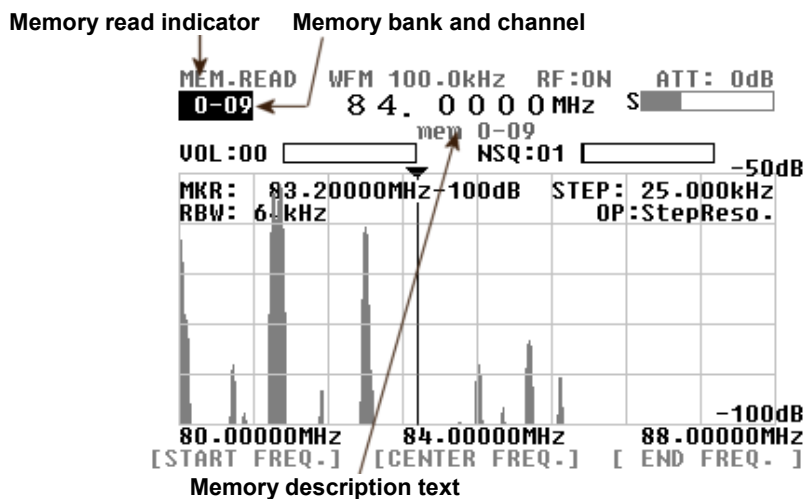

First, select the desired memory bank and channel using the numeric keys. The first single digit number will be the bank and second 2-digit number will be the channel. If you enter an incorrect parameter, an error beep will sound.

Alternatively you can use the dial knob to select the desired bank number and channel. Make sure the memory bank indicator is selected in reverse contrast then rotate the dial knob to step through the memories until you arrive at your desired memory.



Example:

You would like to recall the memory bank [0] with the memory channel [09]:

Press the **0**, **0**, **9** keys

By rotating the dial knob, either left or right, browse through the existing memory banks/channels.

To select the memory bank/channel by reverse contrast:

Press the **FREQ.** key.

8-2 Memory scan

To scan the frequencies that are stored in the bank/memory channels; whilst in memory read mode press the **FUNC** key, then press the **3** key. As in the plot below, the frequencies of the detected signals (according to the squelch settings) are listed on the screen. If you wish to select another bank; with M. scan bank selected simply enter the bank number using the keypad. Whilst scanning the screen will be overwritten by the 31st frequency. The displayed frequencies (maximum 30) remain until the operation mode is changed (such as selecting VFO) or the screen is overwritten with new frequencies, or the power is switched off.

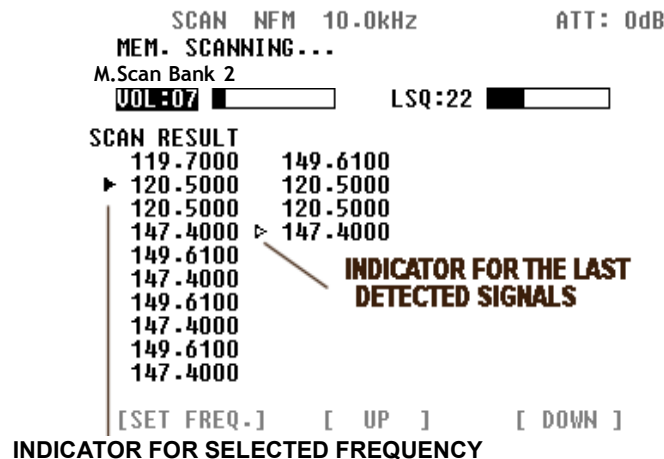

This memory scan behavior depends on the squelch delay time (between squelch closing and scan restart). This is set in the [configuration menu] (see page32). If you wish to bypass the configured delay settings, press the **MHz** key to force detection to the next higher frequency in the list, or press the **kHz** key to go to the next lower frequency.

You can pick up any of the detected frequencies and copy it to the VFO screen for live analysis. To do so, select the desired frequency with the solid white pointer symbol by using the **UP** or **DOWN** soft keys, then press the **SET FREQ.** soft key. The frequency will be transferred to the VFO; all the other settings will not transfer, such as mode, bandwidth, etc. These will remain as they were previously set in VFO mode.



To force the next signal detection:

Press the **MHz** key for scanning up.
 Press the **kHz** key for scanning down.
 To change bank select bank no. using keypad

To copy a frequency onto the VFO:

Select the frequency with the **UP** or **DOWN** soft keys.
 Press the **SET FREQ.** soft key.

8-3 Programming the memory

In either the VFO mode or the Memory read mode, access the memory-programming page by pressing the **MHz** key for two seconds, or by pushing the **FUNC** key followed by the **3** key for one second. Use the **UP** and **DOWN** soft keys to scroll through the page.

```
UFO  WFM 100.0kHz  RF:ON  ATT: 0dB
      84.0000MHz
VOL:07 [ ] NSQ:22 [ ]
MEMORY CHANNEL WRITE
BANK-CH 1-08 is Empty
FREQ 84.0000MHz
MODE WFM
TEXT... mem 1-08

[ UP ] [ DOWN ]
```

- **Bank channel (BANK-CH)**

An available bank and memory channel are automatically selected (bank 0 by default, as long as there are available channels). It is possible to choose another bank/channel with the numeric keys.

- **Frequency (FREQ)**

The frequency automatically displayed is the one that was active in your previous VFO mode. You can input any other frequency with the numeric keys followed by the **MHz** key.

- **Receive mode (MODE)**

The automatically displayed receive mode is the one which was active in your previous VFO mode. You can choose another mode with the dial knob, followed by the **MHz** key.

- **Memory text (TEXT)**

If desired, a text of up to 12 characters can be associated with your selected frequency. Consult the following paragraph 8-4 about how to input.



To select the receive mode:

Rotate the dial knob, and press the **MHz** key to confirm.

To save all your selections:

Press and hold the **MHz** key for two seconds.

To leave this screen without saving any changes:

Press the **CLR** key.

8-4 Memory text input

A text of up to 12 characters can be assigned to each memory channel. To access the memory text screen, press the **MHz** key. With the TEXT line selected in reverse contrast. This gives you access to the screen shown below:

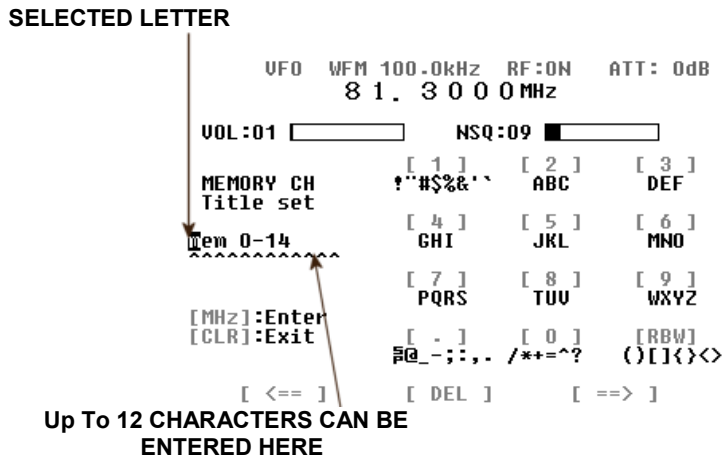

- **Soft keys (<=>, DEL, ==>)**

The soft keys <=> and ==> allow you to go to the previous/next character, while DEL soft key deletes the selected character.

- **Character input**

Sets of characters are assigned to each numeric key, as displayed on the monitor. For example, when you press the 2 key, the assigned characters scroll through as follows:

A → B → C → a → b → c → 2 → A →

When a different key is pressed, the cursor goes automatically to the next character.

- **Saving your changes**

To save your text input, press the MHz key, which will bring you to the Memory Programming Page (previous paragraph 8-3). Remember to press and hold the **MHz** key again for 2 seconds to save all your changes.



To save your text input:

Press the **MHz** key.

To leave this screen without saving any changes:

Press and hold the **CLR** key for 2 seconds.

8-5 Selected memory scanning

The Selected Memory Scanning function allows you to scan only a selection of the frequencies that were previously saved as memory channels. A maximum of 100 channels within a bank can be scanned.

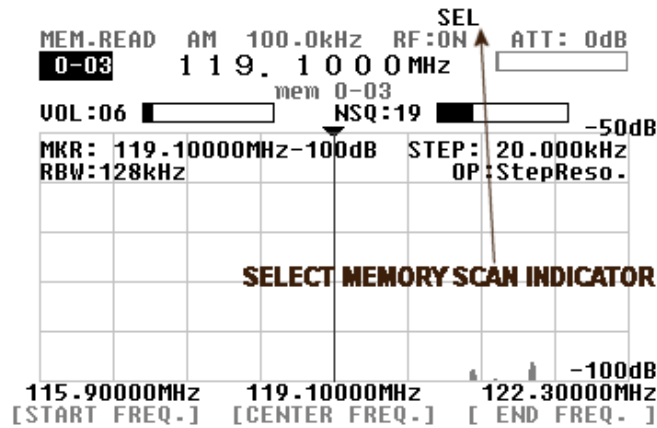

In this example, memory [mem 0-03] is chosen.

- **Accessing a selection (S SET)**

Once you are in the Memory Read mode (as shown above), the desired memory can be chosen in the normal way, then it can be chosen as part of the select scan by pressing the FUNC key followed by the 6 key (S.SET). The **SEL** icon will appear on the top of the screen to show the memory has been selected.

- **Activating select scan (S SCAN)**

Press the **FUNC** key followed by the 5 key to activate the scanning of the selection you have previously set. There must be at least one channel in the memory bank, for the scanning mode to function.

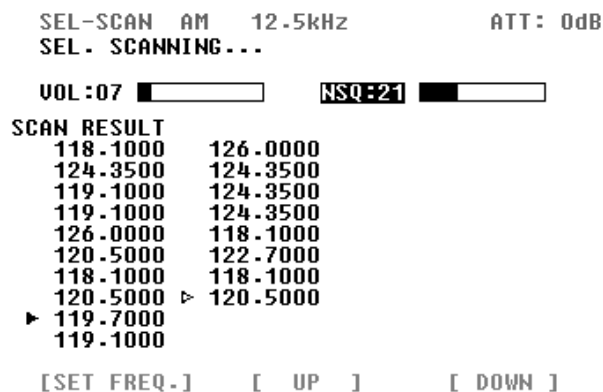

You can select any of the detected frequencies and copy it onto the VFO screen for live analysis. To do so, select the desired frequency with the solid white triangle using the **UP** or **DOWN** soft keys, then press the **SET FREQ.** soft key.



To copy a frequency to the VFO mode screen:

Move the cursor with the **UP** or **DOWN** soft keys.
Press the **SET FREQ.** soft key.

8-6 Priority monitor

The priority function enables you to carry on scanning or monitoring while the SR2000A checks a selected frequency for activity.

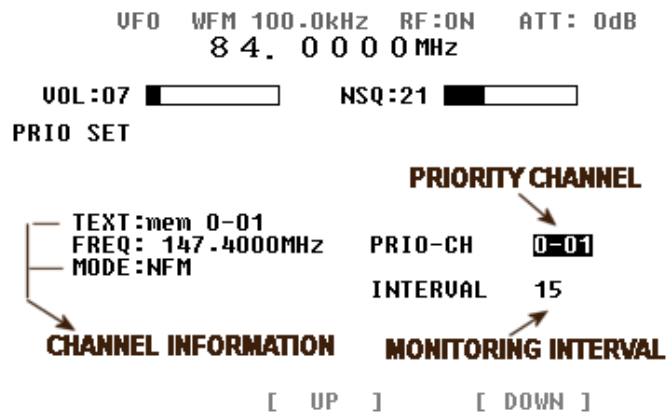

- **Priority set up (PRIO)**

You can access the Priority mode set up screen from either the VFO mode or memory read mode, by pushing the **FUNC** key, then pushing and holding the **7** key for 2 seconds.

First select the memory bank/channel number (using the numeric keys) that contains the frequency you would like to use as the priority channel. Then using the **DOWN** soft key, decide the interval (in seconds) at which this priority channel should be monitored. Possibilities are from 1 ~ 20 seconds.

Press and hold the **MHz** key for 2 seconds to save your settings, or press the **CLR** key if you wish to leave without saving.



To save all your selections:

Press and hold the **MHz** key for 2 seconds.

To leave this screen without saving any changes:

Press the **CLR** key.

- **Engaging the priority channel**
Pressing the **FUNC** key followed by the **7** key allow you to engage the priority function. The **PRIO** icon appears on the top of the screen, indicating that the priority is ON. The **INTERVAL** value determines how long the SR2000A will wait between cycles before

re-sampling the priority frequency for activity. If no activity is detected, the receiver returns to its previous state.

Note: When the SR2000A switches to the priority channel, a switching noise may be heard. However, it is normal.

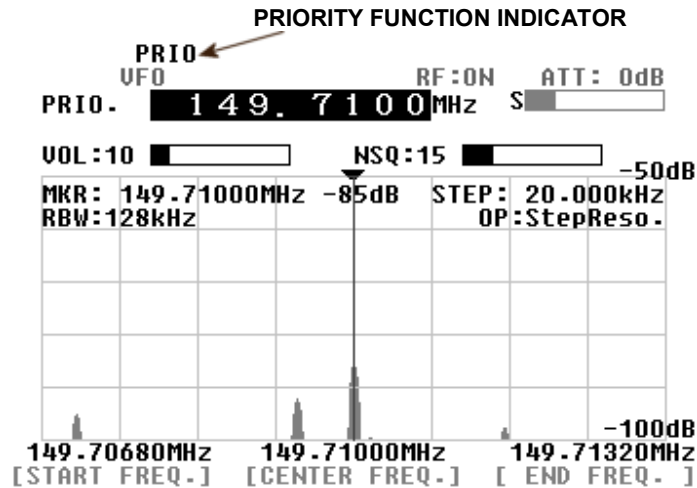

9 Frequency Offset

This function enables the received frequency to be quickly shifted by a pre-determined value that makes it easy to track duplex transmissions or check repeater inputs/outputs.

- **Setting up an offset frequency**

The frequency offset menu is accessed by pressing the **FUNC** key, followed by a two second press of the [,] (Decimal point) key.

Using the numeric keys, the offset frequency can be selected between 0 ~ 999.9999 MHz.

With the **DIRECTION** soft key specify whether the offset frequency is + or – the main frequency. To save your settings and to return to the previous screen, press the **MHz** key. If you wish to quit without saving, press the **CLR** key.

```

UFO NFM 10.0kHz RF:ON ATT: 0dB
4 5 1 . 0 5 0 0 MHz
UOL:07 NSQ:08

OFFSET
FREQ. + 8.0000MHz

[MHz]:Enter
[CLR]:Exit

```

[DIRECTION]
SWITCH BETWEEN + AND – THE VALUE

- **Activating frequency offset**

Activation is possible only in the VFO mode and the Memory read modes. Press the **FUNC** key followed by the **[.]** (decimal) key. The **DUP** icon will display on the top of the screen to confirm operation.

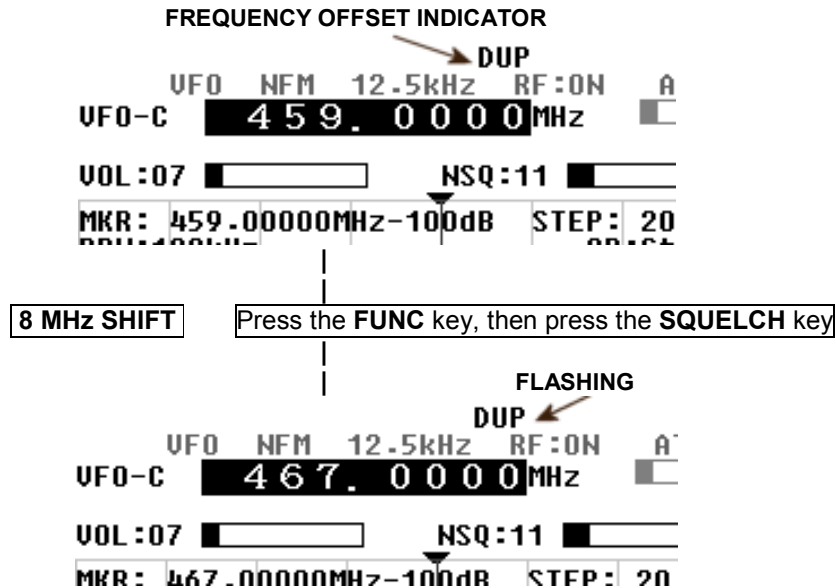

- **Monitoring the offset frequency**

To access the offset frequency when in duplex mode, press and hold the **SQUELCH** for 2 seconds, or alternatively press the **FUNC** key followed by the **SQUELCH** key. A flashing **DUP** icon will show the offset frequency is being monitored.

10 Normal Search and FFT Search

The SR2000A has 40 search banks (01-40) to which can be applied to **Normal Search** as well as **FFT Search**. In both cases, search bank usage is similar.

10-1 Programming Search banks

To access the Search bank settings menu page, press the **FUNC** key, then press and hold the **2** key for two seconds.

Move the cursor to your desired selection with the **UP** and **DOWN** soft keys.

UFO WFM 100.0kHz RF:ON ATT: 0dB
UFO-H 84.0000MHz

VOL:07 NSQ:21

SEARCH BANK 01
BANK BANK
WRITE L-FREQ 110.0000MHz
H-FREQ 136.0000MHz
MODE AM
STEP 12.5kHz
TEXT... SAMPLE

[UP] [DOWN]

- **Search bank number (BANK)**

Select a bank number between 01 and 40.

- **Lower frequency limit (L-FREQ)**

Enter the search lower frequency limit. Press the **MHz** key to confirm.

- **Higher frequency limit (H-FREQ)**

Enter the search higher frequency limit. Press the **MHz** key to confirm.

- **Receive mode (MODE)**

Using the dial knob, select the desired receive mode. Then press the **MHz** key to confirm.

- **Frequency step (STEP)**

Choose your desired frequency step in kHz with the dial knob. Then press the **MHz** key to confirm.

- **Bank text (TEXT)**

You can name each search bank, as described in paragraph 8-4.



To save all selections:

Press and hold the **MHz** key for two seconds. After the search bank set up is completed, the SR2000A will start the normal search.

To leave this screen without saving any changes:

Press the **CLR** key.

10-2 Normal Search

- **Search (SRCH)**

Activate the search with the **FUNC** key followed by the **2** key, and it will start searching in the frequency range you have specified in the search bank menu (paragraph 10-1).

The two-digit bank channel can be changed while search is active.

Search is resumed manually either with the **MHz** key to go up, or **kHz** key to go down the frequency range.

BANK TEXT DESCRIPTION

```

SEARCH AM 12.5kHz ATT: 0dB
SEARCHING...
Search Bank 03 AIR BAND
VOL:07 [ ] NSQ:30 [ ]
SEARCH RESULT
120.4500 119.7500 121.2500
121.2500 119.7625 121.9000
▶ 121.2625 120.0000 124.1000
121.9000 120.5000 ▶ 124.7500
125.2500 121.2500
125.9500 121.2625
126.0000 121.7000
118.1000 121.9000
118.7875 123.7000
119.7000 126.0000
[SET FREQ.] [ UP ] [ DOWN ]
EXAMPLE OF SEARCH BANK 03 UNDER PROCESS
  
```

- **Nonstop search**

If you press again the **FUNC** key and **2** keys while the search is active (as plotted above), You will enter the **Nonstop search mode**.

The SR2000A will continuously search in the frequency range you have specified.

You can exit that mode by repeating the same steps. As the screen can only display 30 frequencies on the screen, new frequencies will overwrite the older ones.

```

SEARCH AM 12.5kHz ATT: 0dB
Nonstop-SEARCHING...
Search Bank 03 AIR BAND
VOL:07 [ ] NSQ:37 [ ]
SEARCH RESULT
121.2500 123.6750
121.9000 121.2500
124.2000 121.9000
119.1000 119.7000
121.2500 121.2500
121.8250 121.9000
121.9000 ▶ 126.0000
▶ 126.0000
121.2500
121.9000
[SET FREQ.] [ UP ] [ DOWN ]
NONSTOP (CONTINUOUS) SEARCH
  
```

You can transfer any of the detected frequencies to the VFO screen for live analysis by selecting the desired frequency with the solid white pointer indicator using the **UP** and **DOWN** soft keys, then press the **SET FREQ.** soft key.



To copy a frequency to the VFO screen:

Move the cursor with the **UP** or **DOWN** soft keys. Press the **SET FREQ.** key.

10-3 Frequency Pass setup

Frequency Pass allows individual frequencies to be passed so they will be skipped over when in normal search mode (including nonstop search). Each of the 40 search banks have 50 pass frequencies available making a total of 2000.

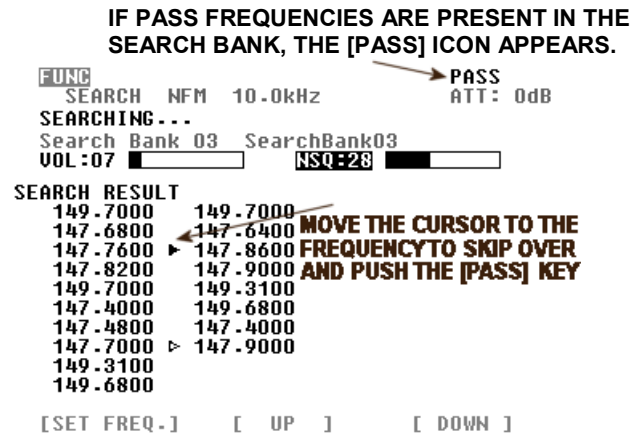

While in the Search mode, press the **FUNC** key followed by the **MODE** key to access the PASS mode. In the example above, the frequency 147.86 MHz is selected from the search result list by the solid white pointer cursor (with the **UP** or **DOWN** soft keys), and set as a PASS FREQUENCY by pressing the **SET FREQ.** soft key. Each bank accepts up to 50 pass frequencies. An error beep will sound if you try to register more than this maximum.

- (Note)
1. Up to 30 out of 50 pass frequencies are displayed on the screen at a time.
 2. This function is not available in the FFT search mode.

- Frequency Pass Browser menu

In the VFO mode or the search mode, press the **FUNC** key followed by a two second press of the **MODE** key to access the frequency pass browser screen. All pass frequencies of the designated search bank will be listed.

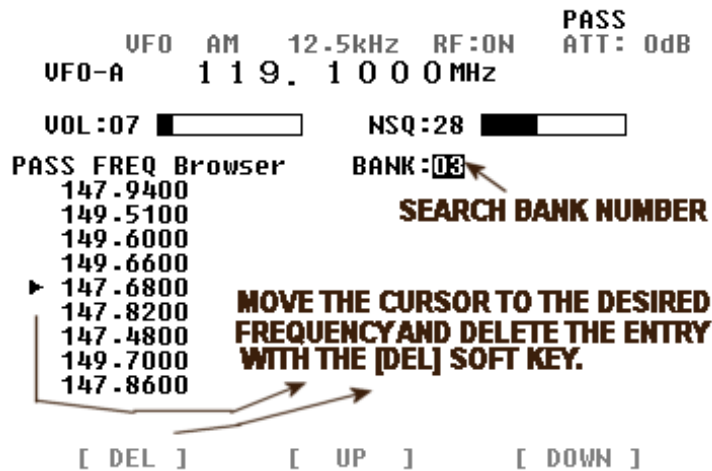

- **Delete pass frequencies**

Use the **UP** or **DOWN** soft keys to move the white cursor to the frequency you wish to erase, and press the **DEL** soft key to delete the entry.

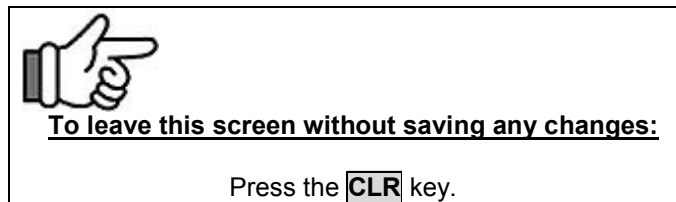

10-4 FFT Search

FFT search differs from regular scanning methods (one frequency / step after the other) in that it provides a spectrum [image] up to 10 MHz wide, sampled 15 times per second.

10-4-1 Search banks and FFT search

Although the search bank basic settings for normal search and FFT search are done the same way (for L-FREQ, H-FREQ and text settings), in FFT search the following parameters must also be set.

FFT Frequency step
Threshold level (signal detection level)

10-4-2 FFT search setup

To access the FFT search mode, press the **FUNC** key, then press the **1** key.

- **Search bank selection**

First select a search bank (two digits) to access and confirm by pressing the **MHz** key.

- **Frequency step selection**

Using the dial knob, select an appropriate frequency step. Then press the **MHz** key to confirm the entry.

- **Using the threshold level**

Set the threshold level with the dial knob. Once set, only signals over this level will be detected by the FFT search. You can adjust the level by actually looking at the spectrum. Once the **MHz** key is pressed, the FFT search will start.

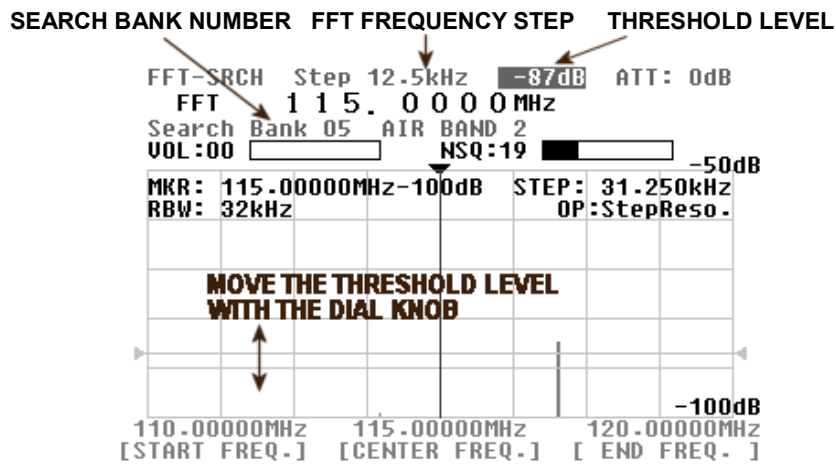



To validate entry:

Press the **MHz** key.

To quit without saving changes:

Press the **CLR** key.

10-4-3 FFT Search Results

If FFT search detects a signal stronger than the set threshold level, then that search result frequency will be listed as on the example below.

Up to 30 frequencies can be listed on one screen. After that, every following result will overwrite the older ones.

```

FFT-SRCH Step 12.5kHz  -92dB  ATT: 0dB
FFT SEARCHING...
Search Bank 01  AIR BAND
VOL:07 ██████████  NSQ:28 ██████████

SEARCH RESULT
▶ 133.2500  133.2500  123.7000
 133.2500  123.7000  123.7125
 133.2500  123.7125  123.7000
 123.7000  123.7000  123.7125
 123.7125  123.7125  133.2500
 131.2500  133.2500  123.7000
 131.2625  133.2500  ▶ 123.7125
 121.2500  121.2500
 123.7000  133.2500
 123.7125  133.2500

[SET FREQ.]  [ UP ]  [ DOWN ]

```

- **Color coded signal levels**

As the FFT search operates at high speed, to render the results more understandable, eight different colors are assigned to different signal levels. Although this display information is limited to the frequency and signal level colors, the real power of the SR2000A is its possibility to output all this data to a PC interface port in a continuous data stream.

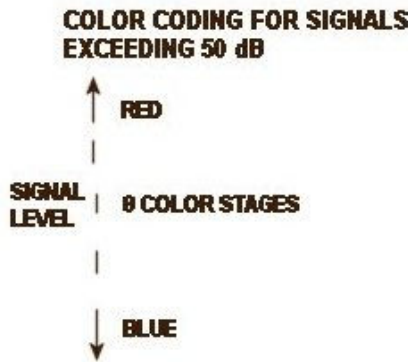

[Note]
Format of the Interface data output to PC:

DL-mm RFnn....
(mm: dB level, nn.....: frequency[Hz])

Please refer to the command list for details.

During the FFT search, it is possible to copy any frequency from the search results to the VFO mode, for further analysis. To do so, use the **UP** or **DOWN** soft keys to move the solid white pointer cursor to the desired frequency, and press the **SET FREQ.** key to switch to VFO (Be aware that you are then exiting the FFT search mode).

While the FFT search results are being listed on the screen, you can switch banks by entering the two digits bank number (this will bring you to the FFT search setup screen).

While the FFT search results are being listed on the screen, by pressing the **CLR** key you can return to the FFT search setup screen and modify parameters. Validate each change by pressing the **MHz** key.



[Caution!]

When FFT search is operating, the resolution bandwidth (RBW) is automatically set to 4 kHz.

11 Delete menu

The SR2000A allows convenient deletion of search banks, memory banks, memory channels, pass banks and pass frequencies in one single Delete menu.

To access the Delete menu function, press the **FUNC** key, then press the **8** key. As in the plot below, move the cursor to the desired selection with the **UP** or **DOWN** soft keys, then press the **DELETE** soft key to delete your selection.

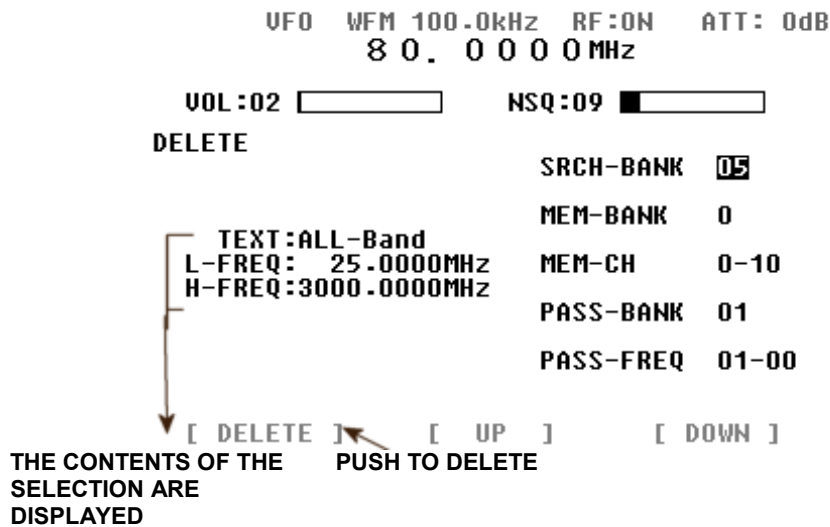

- **Search bank (SRCH-BANK)**

Use the numeric keys to enter the two-digit number of the search bank you wish to delete.

- **Memory bank (MEM-BANK)**

Use the numeric keys to enter the one digit number of the memory bank you wish to delete. All frequencies in this bank will be deleted.

- **Memory channel (MEM-CH)**

Use the numeric keys to enter the three digit of the memory bank/channel you wish to delete. Only the frequency assigned to this channel will be deleted.

- **Pass bank (PASS-BANK)**

Use the numeric keys to enter the two-digit number of the pass bank you wish to delete. All frequencies in this bank will be deleted.

- **Pass frequency (PASS-FREQ)**

Use the numeric keys to enter the three-digit number of the pass bank/frequency you wish to delete. Only the selected frequency will be deleted.

Each time you press the **DELETE** soft key, the screen returns to the previous mode.

To quit the Delete menu without applying changes, press the **CLR** key.

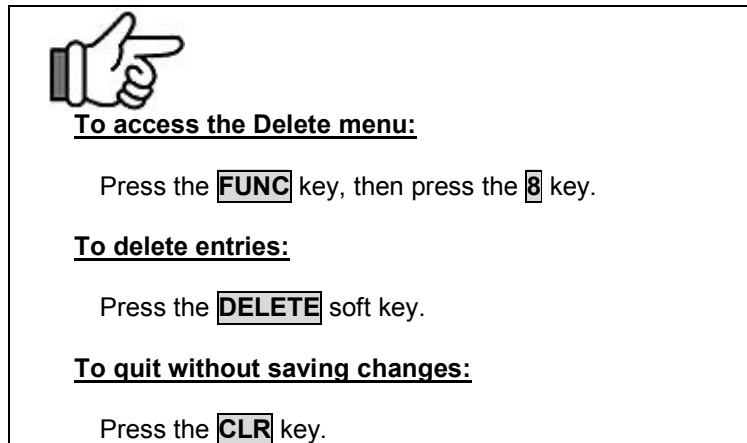

12 Computer control information

Your SR2000A is fully controllable by PC with via the RS-232C serial interface or the USB Interface, by using the supplied COMMAND LIST and Windows Hyperterminal. No specific hardware interface is required, just a straight RS-232C cable or USB-A to USB-B interface cable.

In order to control SR2000A by PC through the USB interface, you need to install the USB driver supplied in the CD.

You can either use the USB driver included in the CD, or the USB driver which can be downloaded from the following URL:

<http://www.ftdichip.com/ftdrivers.htm>

Click [VCP Drivers]: then select the device number [FT232B].

Drivers for other operating systems like Windows 98, ME, CE and Linux are also available on this site.

- 1) Use a USB-A to USB-B cable (not supplied) to connect your PC to SR2000A.
- 2) Power on SR2000A.
- 3) Windows should detect this new hardware (with the message "New Hardware Found" and ask you to locate the driver. Load the supplied driver on CD or a newer version if available from the above mentioned website.

The RS-232C port uses a DB-9 connector.
The SR2000A RS-232C specification is as follows:

Baud rate	9600/19200/38400/57600/115200 bps
Data bits	8
Stop bits	1
Parity	None
Flow control	None

Delimiter

PC → SR2000A

<CR> (0x0d)

or

<CR><LF> (0x0d 0x0a)

Note: <LF> will be ignored

SR2000A → PC

[OK] response when the command has been correct:

<SP><CR><LF> (0x20 0x0d 0x0a)

Response when the command has been incorrect:

? <CR><LF> (0x3f 0x0d 0x0a)

Response to the read command:

Following the output of the parameter, the correct response should read:

<SP><CR><LF> (0x20 0x0d 0x0a)

Numerical parameter auto-correct

The SR2000A corrects the numerical command parameter to the digit format applying to the given parameter. In the following example, the DB command has to be followed by a 3 digit number.

[Example]

The SR2000A will add one or two [0] in order to achieve three digits.

DB3<CR> ----- processed as DB003<CR>

DB03<CR> ---- processed as DB003<CR>

However be aware that for some commands like Memory channel or Search bank, if you input MQ33 for MQ303 (bank 3, channel 3), the SR2000A would mistakenly correct your entry to MQ033 which means bank 0, channel 33.

Format of the data output to PC at search and scan:

FFT search

DL-mm RFnn...

Mm: dB level, nn... : frequency [Hz]

Before [mm] be sure to add [-] (minus)

Normal search and scan

ATn AMn SQn LCxxx RFmmmmnnnnn

Refer to AT, AM, SQ, LC, RF commands for detail

12-1 Command list

Below is the command list for the SR2000A. Each command is explained on the following pages.

AG	AF gain	AM	RF amp
AT	Attenuator	AV	Arithmetic average value
BL	Back light	BP	Beep sound
CS	Channel scope mode	CF	Center frequency
CM	Marker mode	DB	Level search
DD	Delay time	DI	Dial's automatic return parameter
DM	Calculation function mode	DS	Serial port speed
DT	Dial's automatic return	EF	End of frequency
EX	Remote off	FD	High speed data download
FF	FFT search	FP	Spectrum frequency span
FS	Spectrum display step	GD	Graph download
GN	Spectrum input sensitivity	GR	Select memory list read
GA	Select memory	LC	Signal strength output read out
LM	Signal strength read out	MA	Memory channel data read
MB	Memory bank delete	MC	Change marker frequency to CF
MD	Demodulation mode	ME	Median value
MF	Marker frequency	MI	Marker level read out
MO	Marker data read	MQ	Memory channel delete
MR	Memory read mode	MS	Memory scan mode
MU	Mute	MX	Memory data setting
OF	Offset	OL	Offset frequency
OM	Operation mode	PD	Pass frequency delete
PM	Spectrum plot image	PP	Priority monitor setting
PQ	Priority function switch	PR	Pass frequency read
PW	Pass frequency setting	QS	Search bank delete
RF	Monitor receive frequency	RQ	Noise squelch
RS	Reset	RW	Spectrum frequency resolution step
RX	RFU status read	SC	Search/scan stop & non stop
SE	Search bank entry & setting	SM	Select memory scan
SP	Free scan	SQ	Squelch
SR	Search bank read out	SS	Normal search mode
ST	Frequency step (except search)	SV	Copy search data to VFO
TF	Start frequency	TI	Priority interval time
TL	Spectrum peak trigger	TS	FFT frequency step
TT	FFT signal bar level	VR	Firmware version
VX	VFO selection & setting	WF	Waterfall
HV	Video output horizontal position	NP	NTSC/PAL select
RY	Step Up/Down	SL	Serial port select
VO	Video decode frequency	VS	Spectrum/video select
WS	Wide band frequency span	DV	Video decode frequency shift

12-2 Command details

AG AF gain

Setup: AGn<CR> nnn = 0 ~ 72 Default : 0
Acquisition: AG<CR> Response value : AGgnn (fixed length)

AM RF amp

Setup: AMn<CR> n = 0 (off), n = 1 (on) Default : 1
Acquisition: AM<CR> Response value : AMn

AT RF attenuator

Setup: ATn<CR> n = 0 (0dB), n = 1 (10dB), n = 2 (20dB) Default : 0
Acquisition: AT<CR> Response value : ATn

AV Arithmetic average value

Setup: AVnn<CR> nn = 2 ~ 31 Default : 31
Acquisition: AV<CR> Response value : AVnn (fixed length)

BL Back light

Setup: BLn<CR> n = 0 (off), n = 1 (on) Default : 1
Acquisition: BL<CR> Response value : BLn

BP Beep sound

Setup: BPn<CR> n = 0 (mute), n = 1 (on) Default : 1
Acquisition: BP<CR> Response value : BPn

CF Center frequency

Setup: CFm.n<CR> m = 25 ~ 3000 (MHz) n for 100Hz designated value
Acquisition: CF<CR> Response value : CFmmmm.nnnn (MHz) (fixed length)

CM Marker mode

Setup: CMn<CR> n = 0 (marker), n = 1 (peak), n = 2 (continuous peak) Default : 0
Acquisition: CM<CR> Response value : CMn

CS Channel scope mode

Setup: CS nnnn.nnnn mmm.mmm kkkk.kkkk<CR>
Values: nnnn.nnnn start frequency (MHz)
 mmm.mmm step frequency (kHz)
 kkkk.kkkk end frequency (MHz)
Acquisition: CS<CR> Response value : CS nnnn.nnnn mmm.mmm kkkk.kkkk
(Note: This command is available only in the channel scope mode.)

DB Level search

Setup: DBnnn<CR> nnn = 0 ~ 72 Default : 0
Acquisition: DB<CR> Response value : DBnnn (fixed length)

DD Delay time

Setup: DDn.n<CR> n.n = 0 ~ 9.9 (second) FF (hold) Default : 2.0
Acquisition: DD<CR> Response value : DDn.n (fixed length) or DDFF (hold)
(Note: No . (period) is required between n and n when FF is selected.)

DI Main Dial automatic return parameters

Setup: DI<CR> n = 0 (off)
 n = 1 (frequency)
 n = 2 (marker)
 n = 3 (squelch)
 n = 4 (volume) Default : 0
Acquisition: DI<CR> Response value : DI

DM Calculation function mode (spectrum)

Setup: DM<CR> n = 0 (none)
 n = 1 (average)
 n = 2 (maximum)
 n = 3 (median) Default : 0
Acquisition: DM<CR> Response value : DM
(Note: This command also resets the operation.)

DS Serial port speed

Setup: DS<CR> n = 0 (115200 bps)
 n = 1 (57600 bps)
 n = 2 (38400 bps)
 n = 3 (19200 bps)
 n = 4 (9600 bps) Default : 0
Acquisition: DS<CR> Response value : DS

DT Main Dial automatic return

Setup: DT<CR> nn = 1 ~ 30 Default : 10
Acquisition: DT<CR> Response value : DTnn (fixed length)

DV Video decode frequency shift

Setup: DV<CR> n = 0 (normal)
 n = 1 (reversed) Default : 0
Acquisition: DV<CR> Response value : DV

EF End frequency

Setup: EF<CR> m.n = 25.08 ~ 3005 (MHz)
 n for 100Hz designated value
Acquisition: EF<CR> Response value : EFmmmm.nnnn (MHz) (fixed length)
(Note: Depending on the center frequency and the spectrum frequency span, some values cannot apply.)

EX Remote off

Setup: EX<CR> Command valid only for setup

FD High-speed data download

Acquisition: FD<CR>
The level data of each frequency on the screen can be obtained with the following format.
(one frequency data = 1 byte)
FD<SP><CR><LF><SP><SP><SP><SP>(level data)<SP><SP><SP><CR><LF>
The level data is displayed by the following formula.
The reference level is -100 dB (0x20).
(Example) -80dB 0x20+20=0x34 (while 20=0x14)
The data will be converted to ASCII code.
Therefore, the level data is 320.
(Note: When the level data indicates other than 320, the SR2000A is in the channel scope mode. The level data depends on start, step, and end frequencies.)

GR Select memory list read

Acquisition: GRnn<CR> nn = 00 ~ 99 (channel number)
 nn = %% (all channels)
 nn must be in two digits format

HV Video output horizontal position

Setup: HVn<CR> n = 0~49 n = 0 (left end of the screen) Default : 16
 Acquisition: HV<CR> Response value : HVnn (fixed length)

LC Automatic Signal strength output

Setup: LCn<CR> n = 0 (no output)
 n = 1 (output open) Default : 0
 Acquisition: LC<CR> Response value : LCn

LM Signal strength read out

Acquisition: LM<CR>
 The response value depends on squelch type NSQ or LSQ.

In the NSQ mode: ATx AMy NSQm LMnnn

In the LSQ mode: ATx AMy LSQm LMnnn

ATx: x refers to command AT.
 AMy: y refers to command AM.

m = 0 (squelch closed)
 m = 1 (squelch open)
 nnn = 000 ~ 999

MA Memory channel data read

Acquisition: MAMnn<CR>
 m = 0 ~ 9 (bank number)
 nn = 00 ~ 99 (channel number)

Response value as follows:

MXmnn GAn RFnnnn.nnnn MDn SQn ATn AMn TMxx...

MXmnn : m = 0 ~ 9
 nn = 00 ~ 99 (channel number)
 GAn: n refers to command GA
 RFnnnn.nnnn : nnnn.nnnn (MHz)
 MDn: n refers to command MD.
 ATn: n refers to command AT.
 AMn : n refers to command AM.
 TMxx... : xx... message of maximum 12 letters.

MXmnn represents blank channels.

(Note: Refer to the SQ command for detail.)

MB Memory bank delete

Setup: MBn<CR> n = 0 ~ 9 (bank number)
 Command valid only for setup.

MC Change marker frequency to center frequency (CF)

Setup: MC<CR> Command valid only for setup.

MD Demodulation mode

Setup: MDn<CR> n = 0 (NFM)
n = 1 (WFM)
n = 2 (SFM)
n = 3 (AM) Default : 0

Acquisition: MD<CR> Response value : MDn

ME Median value

Setup: MEn<CR> n = 2 ~ 4 Default : 4

Acquisition: ME<CR> Response value : MEn

MF Marker frequency

Setup: MFm.n<CR> m.n = 20 ~ 3005 (MHz)
n for 100 Hz designated value.

However, m.n will depend on the center frequency and frequency span. The initial value is as for CF.

Acquisition: MF<CR> Response value : MFmmmm.nnnn (MHz) (fixed length)

MI Marker level read out

Acquisition: MI<CR> Response value: MIInnn
Nnn = -99 ~ 0 (dB)

MO Marker data read

Setup: MOn<CR> n = 0 (no output)
n = 1 (output active) Default : 0

Acquisition: MO<CR> Response value : MOn

(Note: When the spectrum is displayed, the commands MF and FD are sequentially executed every time the spectrum data is updated.)

MQ Memory channel delete

Setup: MQmnn<CR> m = 0 ~ 9 (bank number)
nn = 00 ~ 99 (channel number)
Command valid only for setup.

MR Memory read mode

Setup: MRmnn<CR> m = 0 ~ 9 (bank number)
nn = 00 ~ 99 (channel number)
Command valid only for setup.

MS Memory scan mode

Setup: MSn<CR> n = 0 ~ 9 (bank number)
Command valid only for setup.

MU Mute

Setup: MUn<CR> n = 0 (mute off)
n = 1 (mute on) Default : 0

Acquisition: MU<CR> Response value : MUn

MX Memory data setting

Setup: MXmnn GAn RFnnnn.nnnn MDn ATn AMn TMxx...<CR>

MXmnn: m = 0 ~ 9 (bank number)
nn = 00 ~ 99 (channel number)

GAn : n refers to command GA.

It is possible to omit it, in which case it is specified by GA0.

RFnnnn.nnnn (MHz)

MDn : n refers to command MD.

ATn : n refers to command AT.

It is possible to omit it, in which case it is specified by AT0.

AMn : n refers to command AM.

It is possible to omit it, in which case it is specified by AM1.

TMxx... : xx... message of maximum 12 letters. It is possible to omit it.

Command only valid for setup.

NP NTSC/PAL select

Setup: NPmn<CR> m: spectrum screen output
M=0 (NTSC), M=1(PAL)

n : Video decode

n = 0 (NTSC)

n = 1 (PAL)

n = 2 (AUTO) Default : 02

Acquisition: NP<CR> Response value : NPmn

OF Offset

Setup: OFn<CR> n = 0 (offset reception off)
n = 1 (offset reception on) Default : 0

Acquisition: OF<CR> Response value : OFn

OL Offset frequency

Setup: OLxmmm.nnnn<CR> x: + or -

The offset direction is therefore indicated.

mmm.nnnn = 0.0001 (100 Hz) ~ 999.9999 (MHz)

Default : 0

Acquisition: OL<CR> Response value : Olxmmm.nnnn

OM Operation mode

Setup: OMn<CR> n = 0 (spectrum analyzer mode)
n = 1 (step resolution mode)
n = 2 (channel scope mode) Default : 0

Acquisition: OM<CR> Response value : OMn

PD Pass frequency delete

Setup: PDmmnn<CR> mm = 01 ~ 40 (search bank)
nn = 00 ~ 49 (channel)

Both bank and channel numbers must be in two digit format.

Command valid only for setup.

PM Spectrum plot image

Setup: PMn<CR> n = 0 (paint)
n = 1 (outline) Default : 0

Acquisition: PM<CR> Response value : PMn

PP Priority monitor setting

Setup: PPMnn<CR> m = 0 ~ 9 (memory bank)
nn = 00 ~ 99 (memory channel)
Acquisition: PP<CR> Response value : PPMnn

PQ Priority function switch

Setup: PQn<CR> n = 0 (off)
n = 1 (on)
Acquisition: PQ<CR> Response value : PQn

PR Pass frequency read

Acquisition: PRmm<CR> mm = 01 ~ 40 (search bank)
Response value : If no frequency is registered in the
PRmm nnnn.nnnn (MHz) list, the only response will be [OK].

PW Pass frequency setting (normal search)

Setup: PWnnnn.nnnn<CR> nnnn.nnnn (MHz)
If no frequency is specified, the present frequency will be
chosen. Command valid only for setup.

QS Search bank delete

Setup: QSnn<CR> nn = 01 ~ 40 (search bank) Command valid only for setup.
(Note: The pass frequencies inside the search bank will also be
deleted.)

RF Monitor receive frequency

Setup: RFnn.nn<CR> nn.nn = 25 ~ 3000 (MHz)
Acquisition: RF<CR> Response value : RFnnnn.nnnn (MHz) (fixed length)

RQ Noise squelch

Setup: RQn<CR> nn = 0 ~ 72 Default : 0
Acquisition: RQ<CR> Response value : RQnn (fixed length)

RS Reset

Setup: RS<CR> Command valid only for setup.

*This command does not delete search bank or memory channels.
The receiver needs to restart after executing this command.*

RW Spectrum frequency resolution step

Setup: RWn<CR> n = 0 (1 kHz)
n = 1 (4 kHz)
n = 2 (32 kHz)
n = 3 (64 kHz)
n = 4 (128 kHz) Default : 2
Acquisition: RW<CR> Response value : RWn

RX RFU (Receiver unit) status read

Acquisition: RX<CR> Response values are as follows:

In the memory channel mode:

MR MXmnn GAn RFmmmm.nnnn STmmm.n MDn ATn AMn TMxx...
(Unit: RF: in MHz, ST: in kHz)

In the memory scan mode:

MS MXmnn GAn RFmmmm.nnnn STmmm.n MDn SQn ATn AMn TMxx...
(Unit: RF: in MHz, ST: in kHz)

In the select memory channel mode:

SM MXmnn GAn RFmmmm.nnnn STmmm.n MDn SQn ATn AMn TMxx...:
(Unit: RF: in MHz, ST: in kHz)

In the normal search mode:

SSnn RFmmmm.nnnn STmmm.n MDn SQn ATn AMn TTxx...
(Unit: RF: in MHz, ST: in kHz)

In the FFT search mode:

FFmm TSnn TT-kk (Refer to command FF)

In the VFO mode:

Vx RFmmmm.nnnn STmmm.n MDn ATn AMn
(Unit: RF: in MHz, ST: in kHz)

In the WSP (Wide Span) mode:

WSxx RFmmmm.nnn (Refer to command WS)

Refer to each command for details.

***R*Y Step Up/down**

Setup: RYn<CR> n = 0 (step up)
n = 1 (step down)
Command valid only for setup

SC Search / scan stop & non stop

Setup: SCn<CR> n = 0 (stop mode)
n = 1 (non stop mode) Default : 0
Acquisition: SC<CR> Response value : SCn
(Note: FFT search is always in non stop mode.)

SE Search bank entry & setting

Setup: SEnn SLnn... SUnn... STnn... MDn ATn AMn TTxx...<CR>
SEnn: nn = 01 ~ 40 (search bank number, always two digits)
SLnnnn.nnnn: search lower end (MHz)
SUnnnn.nnnn: search higher end (MHz)
STnnn.n: search step frequency (kHz)
MDn : n refers to command MD.
ATn : n refers to command AT.
It is possible to omit it, in which case it is specified by AT0.
AMn : n refers to command AM.
It is possible to omit it, in which case it is specified by AM1.
TTxx... : xx... message of maximum 12 letters. It is possible to omit it.

Each command has to be separated by a blank space.
Command only valid for setup.

SL Serial port select

Setup: SLn<CR> n = 1 (REMOTE 1)
n = 2 (REMOTE 2) Default: 2
Acquisition: SL<CR> Response value : SLn

SM Select memory scan

Setup: SM<CR> Command valid only for setup

SP Free scan

Setup: SPn.n<CR> n.n = 0.0 ~ 9.9 (second)
n.n = 0 for value zero, the free scan is OFF. Default : 0
Acquisition: SP<CR> Response value : SPn.n

SQ Squelch

Setup: SQn<CR> n = 0 (noise squelch)
n = 1 (level squelch) Default : 0
Acquisition: SQ<CR> Response value : SQn

SR Search bank read out

Setup: SRnn<CR> nn = 01 ~ 40 (search bank number)
Response value :
SRnn SLnnnn.nnnn Sunnnn.nnnn MDn SQn ATn AMn TTxx....
(Note: Refer to the SE command for details.)

SS Normal search mode

Setup: SSmm<CR> mm = 01 ~ 40
The search bank number must always be two digits.
Command valid only for setup.

ST Frequency step (except search)

Setup: STnnn.nnn<CR> nnn.n = 0.1 ~ 100.0 (kHz), 6.25 (kHz), 8.33 (kHz)
Default :10
Acquisition: ST<CR> Response value : STnnn.nnn

SV Copy search data to VFO

Setup: SVn<CR> n = 0 ~ 8, n = 0 (VFO-A)
n = 1 (VFO-B)
n = 2 (VFO-C)
n = 3 (VFO-D)
n = 4 (VFO-E)
n = 5 (VFO-F)
n = 6 (VFO-G)
n = 7 (VFO-H)
n = 8 (VFO-I) Default : 0 (VFO-A)
Command valid only for setup.

TF Start frequency

Setup: TFmm.nn<CR> m.n = 20 ~ 2999.92 (MHz)
n for 100Hz designated value
Acquisition: TF<CR> Response value : TFnnnn.nnnn (MHz)
(Note: Depending on the center frequency and the spectrum frequency span, some value cannot apply.)

TI Priority interval time

Setup: TInn<CR> nn = 1 ~ 20 (second) Default : 5
 Acquisition: TI<CR> Response value : TInn

TL Spectrum peak trigger

Setup: TL-nn<CR> nn = 0 ~ 99 Between TL and nn, the minus sign (-) is necessary.
 Default : -90
 Acquisition: TL<CR> Response value : TL-nn

TS FFT frequency setup

Setup: TSnn<CR> nn = 2 ~ 12,
 nn = 2 (5 kHz)
 nn = 3 (6.25 kHz)
 nn = 4 (8.33 kHz)
 nn = 5 (9 kHz)
 nn = 6 (10 kHz)
 nn = 7 (12.5 kHz)
 nn = 8 (20 kHz)
 nn = 9 (25 kHz)
 nn = 10 (30 kHz)
 nn = 11 (50 kHz)
 nn = 12 (100 kHz) Default : 6 (10 kHz)
 Acquisition: TS<CR> Response value : TSnn

TT Signal bar level

Setup: TT-nn<CR> nn = 0 ~ 99 (dB) Between TT and nn, the minus sign (-) is necessary.
 Acquisition: TT<CR> Response value : TT-nn

VO Video decode frequency

Setup: VOn<CR> n = 0 (same as audio frequency)
 n = 1 (-2.65 MHz offset) Default : 0
 Acquisition: VO<CR> Response value : VOn

VR Firmware version

Acquisition: VR<CR> The response value corresponds to the version number.

VS Spectrum/video select

Setup: VSnn<CR> n = 0 (spectrum)
 n = 1 (video) Default : 0
 Acquisition: VS<CR> Response value : VSnn

VX VFO selection & setting

Set up: Vxn.n Selection: x = A ~ I,
 x = A (VFO-A)
 x = B (VFO-B)
 x = C (VFO-C)
 x = D (VFO-D)
 x = E (VFO-E)
 x = F (VFO-F)
 x = G (VFO-G)
 x = H (VFO-H)
 x = I (VFO-I)
 Setup: Vxn.nnnn.nnnn<CR> x = A ~ I, nnnn.nnnn = 25.0000 ~ 3000.0000 (MHz)
 (in 100 Hz step)

WF Waterfall function

Setup: WFn<CR> n = 0 (off)
n = 1 (on) Default : 0
Acquisition: WF<CR> Response value : WFn

WS Wideband span

Setup: WSxx RFm.n<CR>
Xx = 20 (MHz width) or 40 (MHz width)
nnnn.nnnn = 35.0000 ~ 2990.0000 (MHz)

13 Specifications

Frequency range	25 ~ 3,000 MHz (Cellular blocked for US consumer version)
Receive modes	AM/NFM/WFM/SFM/APCO25(P25) [Optional]
Receiver configuration	Triple conversion super heterodyne
IF frequency	1 st 254.3 / 744.3 MHz 2 nd 10.7 MHz 3 rd 455 kHz
Sensitivity	25 MHz ~ 225 MHz NFM 0.35 μ V (12 dB SINAD) AM 0.6 μ V (10 dB S/N) WFM 2.0 μ V (12 dB SINAD) 225 MHz ~ 1.7 GHz NFM 0.35 μ V (12dB SINAD) AM 0.8 μ V (10dB S/N) WFM 2.0 μ V (12dB SINAD) 1.7 GHz ~ 2.7 GHz 0.6 μ V (12 dB SINAD) 2.7 GHz ~ 3 GHz NFM 1.5 μ V (12 dB SINAD)
IP3	25 MHz ~ 225 MHz +1.0 dBm 225 MHz ~ 1.7 GHz +1.0 dBm 1.7 GHz ~ 2.7 GHz +1.0 dBm 2.7 GHz ~ 3 GHz +1.0 dBm
S/N	25 MHz ~ 225 MHz 40 dB 225 MHz ~ 1.7 GHz 35 dB 1.7 GHz ~ 2.7 GHz 32 dB 2.7 GHz ~ 3 GHz 30 dB
Frequency stability	+/- 1 ppm (0-50 °C, 32-122 °F)
LCD	5 inches TFT color LCD
Memory channels	1,000
Search banks	40
Pass channel memory	2,000
Priority channel	1
Operation modes	Spectrum mode, Step resolution mode, Channel scope mode
Resolution Band Width	1, 4, 32, 64, 128 kHz
Input Impedance	50 Ω
Audio output	1.2 W (@ 8 Ω) 10% THD
Speaker	Internal
PC interface	RS-232C or USB
Power requirements	12 ~ 16 V DC @ 1.5 A (at 1 W audio output)
Control keys	26,keys, one (1) dial
Operating Temperature	0-50 °C, 32-122 °F
Dimensions (Projects not included)	220 (W) x 120 (H) x 185 (D) (mm) 8.7 (W) x 4.7 (H) x 7.3 (D) (inches)
Weight	3.2 Kg (7.1 lbs)

All specifications are subject to change without notice or obligations.

14 LIMITED WARRANTY

*** Only valid if purchased in the U.S. For other countries please inquire the official AOR distributor or store where you purchased SR2000A.**

AOR USA, Inc. (AOR) warrants its products as described below:

AOR will repair or exchange equipment as a result of defects in parts or workmanship for a period of one year from the date of original retail purchase from an authorized AOR dealer.

Exclusions

The following items are not covered by the AOR limited warranty:

1. Products that are damaged through accident, abuse, misuse, neglect, or user modifications.
2. Problems that arise through failure to follow directions in the owner's manual.
3. Exposure of the product to adverse or severe weather conditions, including temperature extremes or water, including rainfall or immersion.
4. Exposure to toxic materials, biohazards, radioactive materials or other contamination.
5. Repairs attempted by parties other than AOR or its authorized personnel
6. Damage that results from improper installation, including improper voltage and/or reversed polarity, or exposure of a receiver to signal levels exceeding specifications.
7. Damage resulting through the use of accessories from manufacturers other than AOR.
8. Equipment that has had serial numbers removed or altered in any way.
9. Damage that occurred as a result of shipment. Claims must be presented to the carrier.
10. AOR is not responsible for any costs arising from installation or reinstallation of the equipment, or for any consequential damage claims (such as loss of use).

Obtaining Warranty Service

1. You are responsible for shipping the product to AOR and any related costs.
2. A legible copy of the original product purchase receipt must accompany any warranty claim.
3. You must include a description of the problem(s) encountered with the product.
4. You must include your name, a valid ground shipping address (including zip code) and telephone contact information.
5. AOR will ship the repaired (or replaced) product by ground transport.

Limitations

Any and all implied warranties, including those pertaining to merchantability and utility for a specific purpose are limited to the duration of this limited warranty. AOR's limits on warranty pertain only to the repair or, at its option, replacement of defective products. AOR shall not be liable for any other damages, including consequential, incidental or otherwise, arising from any defect.

Some states do not allow limitations on how long an implied warranty lasts and may not

allow the exclusion of incidental or consequential damages. As such, the above limitations may not apply in every case. This warranty gives you specific legal rights and you may have other rights that apply in your state.

If you have questions about this limited warranty, or the operation of your AOR product, contact AOR at (310) 787-8615 during normal business hours (9 am ~ 5 pm Pacific Time Zone), or write to AOR USA, INC., 20655 S. Western Ave., Suite 112, Torrance, CA 90501. You may also send a fax to AOR at (310) 787-8619. Additional information is available at the AOR web site: www.aorusa.com/support.html

We suggest attaching your purchase receipt to this half of the warranty information sheet and that you keep this information in a secure location.

AOR Model Number _____

Serial Number _____

Dealer Name _____

Purchase Date _____

AOR, LTD.
2-6-4, Misuji, Taito-Ku
Tokyo, 111-0055, Japan
www.aorja.com
mail@aorja.com

AOR USA, INC.
20655 S. Western Ave. Suite 112
Torrance, CA 90501, U.S.A.
Phone: 310-787-8615
Fax: 310-787-8619
www.aorusa.com
info@aorusa.com

Copyright 2013
All rights reserved

June 10, 2013