

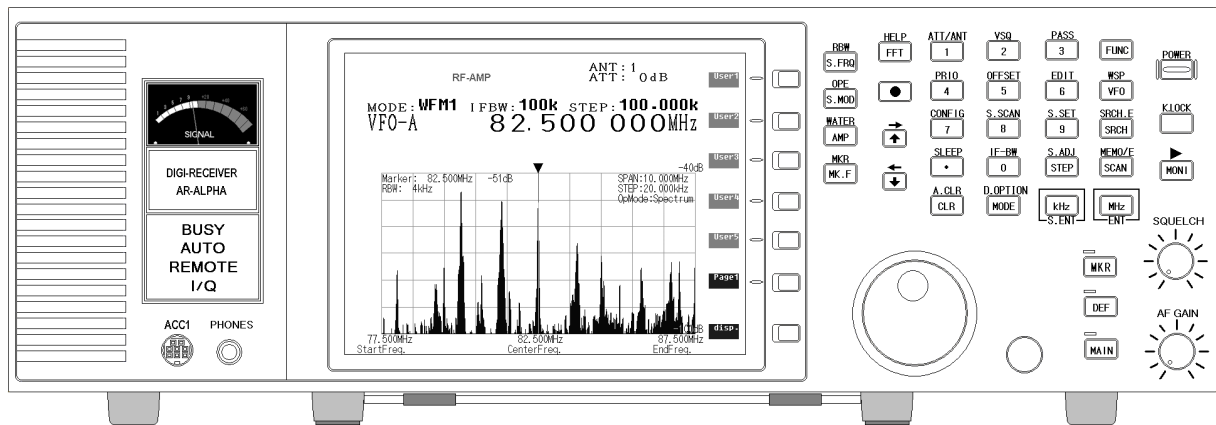

AR-ALPHA

Digital Processing Communications Receiver



Operating Manual

AOR, LTD.

Table of Contents

1. Introduction	5
1-1 Introduction	5
1-2 Caring for your radio	7
1-3 Please note these operating procedures	8
1-4 Accessories supplied	8
1-5 Controls and functions	13
Front Panel	13
1-5-1 Keypad	14
1-5-2 Summary of keys	14
Rear Panel	29
2. Getting Started	33
2-1 Preparing the AR-ALPHA for operation	33
2-1-1 Connecting the antenna	33
2-1-2 Connecting power	33
2-2 Switching on for the first time	34
2-3 Squelch Circuit	35
2-4 VFO selection	35
2-4-1 Tuning frequency	36
2-4-1-1 Entering a frequency using the numeric keypad	36
2-4-1-2 Changing frequency using the main tuning dial	37
2-4-1-3 Changing frequency using the arrow keys	37
2-5 Changing receive mode	38
2-5-1 Auto mode selection	39
2-5-2 Receive mode selection	39
2-5-3 Additional decoding modes	42
2-6 Changing tuning step size	43
2-7 IF bandwidth	44
2-7-1 Manually selecting IF band width	45
2-8 Attenuator	45
2-9 Offset	46
2-9-1 Using pre-programmed frequency offset data	46
2-9-2 Entering new frequency offset data	47
2-9-3 Activating frequency offset	48
2-9-4 Monitoring the offset frequency	48
2-9-5 Deactivating frequency offset	49
3. Spectrum Display	49
3-1 LCD Display Screen (in VFO spectrum analyzer mode)	49
3-1-1 Operation mode display	50
3-1-2 Basic operation display	50
3-1-3 Spectrum display (example)	51
3-2 Display span setting	53
3-2-1 Setting the display span	54

4. Memory channels	56
4-1 Memory Bank and Memory Channel	56
4-2 Storing VFO frequency and data into memory	57
4-3 Memory read "M.RD"	58
4-4 Memory Mode	59
4-4-1 From Bank List screen to MemBank screen or Browser	60
4-4-2 From Bank List to MemCh List	61
4-4-3 From MemCh List to MemCh **. ** Browser	62
5. SCAN – scanning memory channels	65
5-1 SCAN – outline introduction	65
5-2 Starting SCAN	65
5-3 SCAN operation	66
5-3-1 Changing scan direction	67
5-4 Selecting a SCAN bank	67
5-5 Bank link	68
5-5-1 Setting Bank link	68
5-6 Select SCAN	68
5-6-1 Adding select scan channels in memory read	68
5-6-2 Start select scan	69
5-7 Channel Pass	70
5-7-1 Setting channel pass	70
6. Search	71
6-1 Search setting	71
6-1-1 Setting	71
6-1-2 Search Bank Browser setting	72
6-1-3 Start search	72
6-2 Search Group	74
6-2-1 Setting Search Group	74
7. FFT Search	76
7-1 FFT Search setting	76
7-1-1 FFT Search Screen	77
8. Miscellaneous Settings	79
8-1 Soft key registration	79
8-1-1 Operation of soft keys	79
8-1-2 Soft key registration	80
8-2 Voice Recording	80
8-2-1 Recording	81
8-2-2 Stop recording	81
8-2-3 Playback audio	81
8-2-4 Changing record channel	82
8-3 Data Editor	82
8-3-1 Moving memory bank	83
8-3-2 Copying memory bank	84

8-3-3 Moving search bank	-----	85
8-3-4 Copying search bank	-----	85
8-3-5 Moving memory channel	-----	86
8-3-6 Copying memory channel	-----	87
8-3-7 Copying scan group data	-----	87
8-3-8 Copying scan group data	-----	88
8-3-9 Moving search group data	-----	89
8-3-10 Copying search group	-----	89
8-3-11 Moving recorded voice data	-----	90
8-3-12 Deleting memory bank	-----	91
8-3-13 Deleting search bank	-----	91
8-3-14 Deleting memory channel	-----	92
8-3-15 Deleting memory pass channel	-----	92
8-3-16 Deleting all search pass channels	-----	92
8-3-17 Deleting all memory banks	-----	92
8-3-18 Deleting all search banks	-----	93
8-3-19 Deleting voice record channel	-----	93
8-3-20 Deleting all voice record data	-----	93
8-4 Configuration settings	-----	94
8-4-1 Configure backlight	-----	95
8-4-2 Configure beep	-----	95
8-4-3 Configure RF-Gain (Radio Frequency Gain)	-----	95
8-4-4 Configure reference signal input	-----	96
8-4-5 Video display & format	-----	97
8-4-6 Configure I/Q output bandwidth	-----	97
8-4-7 Configure Voice squelch level	-----	98
8-4-7-1 Configure Voice level and delay time	-----	99
8-4-8 Configure PC interface	-----	99
8-4-9 Configure Sleep Timer	-----	100
8-4-10 Configure Priority function	-----	101
8-4-10-1 Setup	-----	101
8-4-10-2 Activating priority function	-----	101
9. Computer control	-----	102
9-1 How to send a control command	-----	102
9-2 Power on	-----	102
9-3 Detailed control command list of the AR-ALPHA	-----	103
10. Specifications	-----	124
11. I/Q digital output in details for developers	-----	126
12. Reset	-----	133
13. Firmware upgrade	-----	134
14. Optional Accessories	-----	138

15. Limited Warranty (USA only)	139
16. Control software	141
16.1 Minimum system requirements	143
16.2 USB driver installation	144
16.3 I/Q driver installation	147
16.4 Software installation	149
16.5 Software registration (single PC & multiple PC)	150
16.6 Software functions	152

1 Introduction

1-1 Introduction

Thank you for purchasing the AR-ALPHA Digital Processing Communications receiver. The AR-ALPHA was designed using the very latest technology to ensure the highest levels of performance and reliability. To get the best possible results from your AR-ALPHA, we strongly recommend that you read this manual to familiarize yourself with the receiver and its many functions.

Although carefully designed, this receiver (and most other receivers) generates internal noises known as spurious emissions. They are a product of the receiver's circuitry, and their presence does not represent a defect. Other apparent defects may be due to unintentional misoperation of the receiver. If you believe there is a problem, carefully read the entire manual before contacting your dealer for advice.

It is acknowledged that sections of this manual are repetitive, this is to enable the manual to be used as a quick reference book (you don't have to read it from cover to cover at one time). Due to the international nature of the product, some graphics may contain Japanese characters.

Every effort has been made to make this manual correct and up to date. Due to continuous development of the receiver, there may be error or omission anomalies and this is acknowledged.

© This manual is protected by copyright AOR, LTD. 2010. No information contained in this manual may be copied or transferred by any means without the prior written consent of AOR, LTD. AOR and the AOR logo are trademarks of AOR, LTD. All other trademarks and names are acknowledged.

Main features:

- Wide frequency coverage: 10 kHz to 3.5 GHz, with no interruptions (USA consumer version has cellular telephone frequencies blocked)
- Zero-IF frequency (for the 3rd IF)
- DDS (Direct Digital Synthesizer) local oscillator
- TV reception in NTSC, PAL, and SECAM formats
- I/Q output with 1 MHz bandwidth
- Multi-mode unit capable of receiving AM (Synchronous), ISB, RZ-SSB, USB, LSB, CW, WFM including FM stereo (when using optional headphones), NFM and APCO P25 digital
- 6-inch TFT color panel can display received video signals or depict spectrum activity over a wide choice of bandwidths including a “waterfall” function to show signal activity over a specified time period
- Composite video output on the rear panel of the unit
- Selectable IF bandwidths: 200 Hz, 500 Hz, 1 kHz, 3 kHz, 6 kHz, 15 kHz, 30 kHz, 100 kHz, 200 kHz and 300 kHz and the ability to shift the IF
- CTCSS and DCS selectable squelch functions
- DTMF tone decode
- Built-in voice-inversion descrambling (Not available on USA consumer version)
- CW pitch control, AGC, AFC
- Auto-notch feature
- User selectable spectrum display function from 250 kHz through 10 MHz in 1 kHz increments. Above 10 MHz bandwidth, it can display 20 MHz, 50 MHz, 100 MHz or 1 GHz, but above 20 MHz bandwidth, no audio will be available
- RBW (Resolution bandwidth) is also user-selectable in increments of 1 kHz, 4 kHz, 32 kHz, 64 kHz and 128 kHz
- Fast Fourier Transform (FFT) spectrum display
- Analog output for DRM PC receiver
- RS-232C and USB 2.0 interfaces
- Two antenna ports (one SO-239 and one Type N). Up to four antennas may be selected through the receiver’s controls with the optional AS5001 antenna relay switch.
- Use desktop or 19” rack mount
- Five VFOs, 2,000 alphanumeric memories
- Digital Voice Recording up to 25 minutes

1-2 Caring for your radio

There are no internal operator adjustments. In the unlikely event of service being required, please contact your dealer for technical assistance.

Do not use or leave the receiver in direct sunlight (especially the LCD). It is best to avoid locations where excessive heat, humidity, dust and vibration are expected. Always keep the AR-ALPHA free from dust and moisture. Use a soft, dry cloth to gently wipe the set clean, never use abrasive cleaners or organic solvents which may damage certain parts.

Treat the AR-ALPHA with care, avoid the spilling or leakage of liquids into the receiver. Special care should be taken to avoid liquid entering around the controls, through the speaker grille or through the connection jacks.

The AR-ALPHA is designed for operation from a high quality regulated DC supply of 12 to 14 V, which should be capable of supplying at least 2.2A. Never connect the AR-ALPHA directly to an AC outlet. The polarity of the DC input jack is clearly marked, the chassis of the receiver is at negative ground.

SAFETY NOTICE – Always disconnect the power supply from the AC outlet when not in use. If used mobile, it should be noted that the AR-ALPHA has NOT been manufactured or tested to meet any specific mobile safety requirements. The AR-ALPHA has no internal user adjustable parts.

If using the AR-ALPHA in a base station situation, the best short wave reception is usually achieved by using a separate external earth (ground) rod, however, consider the implications carefully if the AC supply at your location uses a Protective Multiple Earth (PME) system. If in doubt consult a qualified electrician. Never earth (or ground) to a gas pipe!

The AR-ALPHA has two antenna connectors for all frequencies. These are intended for connection to a 50 Ω (unbalanced) coaxial fed antenna such as a discone, dipole, unipole, Yagi, etc. When locating the antenna, avoid power cables. Ensure that you do not confuse the antenna connection and the 10 MHz frequency reference connector as they are in close proximity.

1-3 Please note these operating procedures

1. Certain key operations are acted upon when the key is **RELEASED**, not while it is pressed. Allow time for the AR-ALPHA to register and process each action before pressing another key.
2. The keylock (**K.LOCK**) is intentionally made difficult to operate to prevent accidental operation. To release the keylock, the **K.LOCK** key must be held for more than one second, the key icon on the LCD confirms operation. The **K.LOCK** is disabled during keying sequences (such as when entering frequencies).
3. Currently displayed VFO data is saved at power down (to increase speed of the operation and to reduce write cycles). For this reason, if the AR-ALPHA is powered down using the **MAIN POWER (rear panel)** switch or external power is removed, the last displayed frequency will be lost and the frequency used prior to this will be displayed the next time the receiver is powered up.

1-4 Accessories supplied

The following items are included in the shipping carton:

1 AR-ALPHA receiver

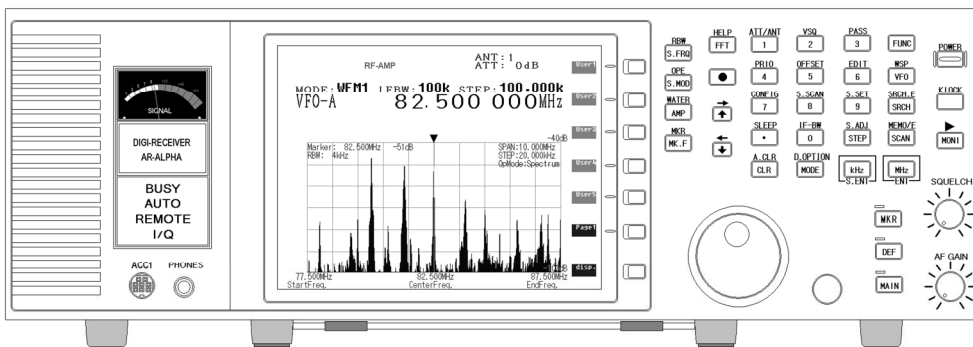

2. DC power cable



3. Operating manual (this booklet)

4 Rack mount handles and screws

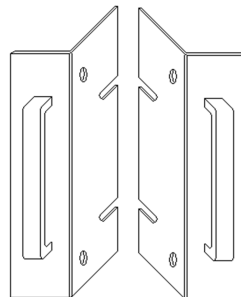

Terminology

Search & Scan

If you have not used a wide band receiver before or you are not familiar with the terminology used, it is very important to understand the difference between **SEARCH** and **SCAN** modes.

SEARCH: The AR-ALPHA provides several operations where transmissions (active frequencies) may be automatically located by sweeping the receiver over a wide frequency range, either from the currently displayed frequency traveling upwards (or downwards) in a specified tuning increment (step) or by sweeping over-and-over between two specified frequency limits. This process is known as **SEARCHING**, as the title implies, it can take a long time to find transmissions due to their 'often intermittent' and brief nature. For this reason it is best to slice large frequency ranges into smaller, more manageable pieces where they may be intensely searched.

When examining large frequency segments, it is common to find that the majority of frequencies are inactive at the time of the search and only a small number of the remaining constitute what you really want. Searching still remains the best way to initially locate active and interesting transmissions (in conjunction with a good list of active frequencies and a band plan).

SCAN: Once active transmissions have been identified (either by searching or by using a good frequency guide), it is more efficient to store the data into memories which can be rapidly and automatically monitored in succession, stopping when activity is encountered. This is a much more efficient means of monitoring the most wanted frequencies you have targeted, that is, what you most want to hear. By contrast, searching is very inefficient for day-to-day monitoring.

Note: It is very important that the squelch is advanced to cancel background noise for the search & scan functions to operate properly. This is because the AR-ALPHA believes that it has found an active frequency when the squelch opens and the "BUSY" lamp lights up. Advance the squelch control clockwise until the background noise is just cancelled, this is known as the "threshold" position. If the squelch control is advanced too far, weaker signals may be missed.

More details about the remarkable features of the AR-ALPHA

Zero – IF (Zero Intermediate Frequency)

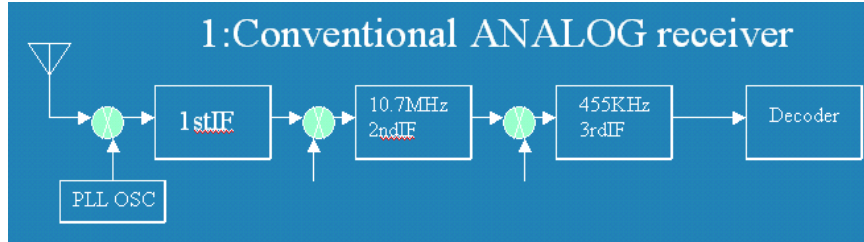

Block diagram 1 shows a conventional triple conversion super heterodyne analog receiver and the 3rd IF frequency is 455 kHz. Due to its frequency configuration, some “image” signals may be received.

Block diagram 2 shows the AOR Zero-IF digital receiver.

The 10.7 MHz 2nd IF analog signal is fed to the ADC (Analog to Digital Converter) to be digitized and the signal is digitally mixed with the 10.7 MHz local oscillator. The signal is digitally processed, and the 3rd IF signal becomes zero (0). By utilizing this technique, no image signal will be present.

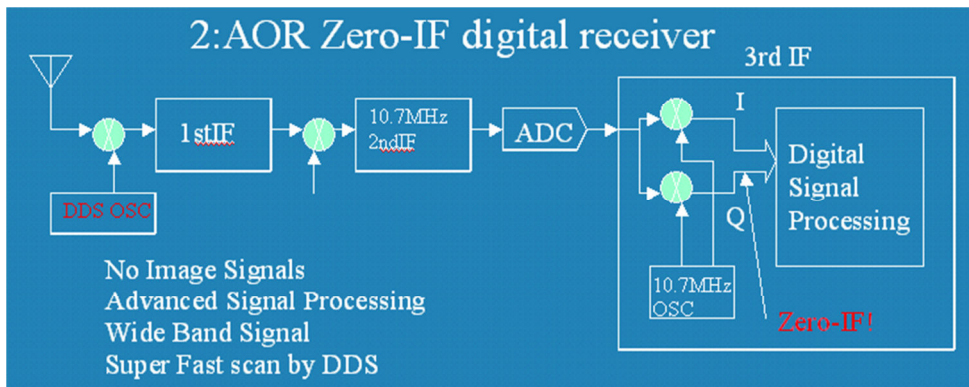

DDS (Direct Digital Synthesizer)

The AR-ALPHA uses high speed DDS for the 1st local oscillator. Unlike standard PLL (Phased Locked Loop) circuits for the local oscillator, DDS enables very fast scanning as it quickly generates signals controlled by the CPU (Micro Processor).

I/Q Digital Output

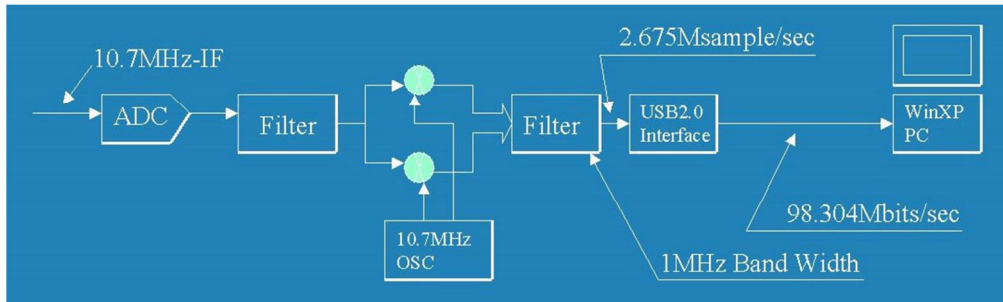

I/Q stands for In-Phase/Quadrature -Phase.

At the 3rd IF stage, the AR-ALPHA provides an I/Q output. The I/Q digital signal consists of two (2) different digital signals that are phase-shifted 90 degrees.

The I/Q output is provided through a continuous isochronous USB 2.0 standard interface. By using the I/Q digital output, the streamed data can be stored on a PC hard disk for future signal analysis.

FFT (Fast Fourier Transform)

The AR-ALPHA utilizes FFT (Fast Fourier Transform) technology for the spectrum display feature.

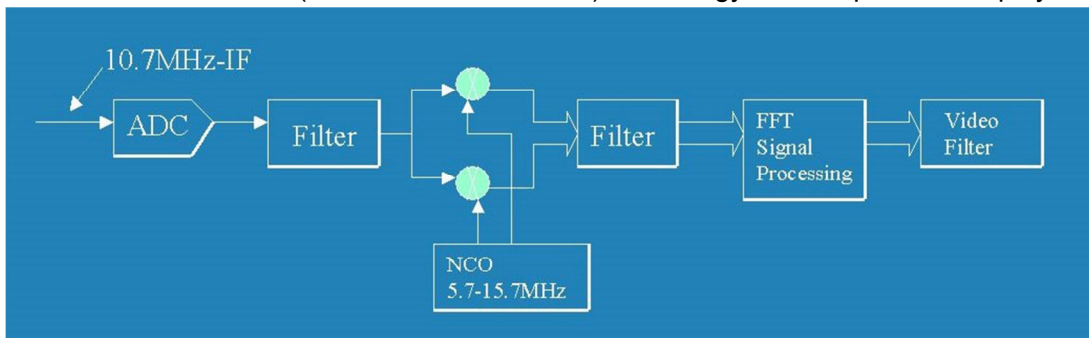

FFT in the AR-ALPHA refreshes the spectrum display more than 10 times per second during a 10 MHz sweep (at 500 Hz RBW). The AR-ALPHA can display a wide range sweep up to 1 GHz.

Receive modes / Additional features

WFM (Wide FM)

- Stereo sound (auto detected), Selectable de-emphasis 50 uS/75 uS
- Stereo output is available from the headphone jack using optional stereo headphones or from the RCA jacks on the rear panel (optional stereo amplifier required)

NFM (Narrow FM)

- Built-in DCS (Digital Coded Squelch)
- Built-in CTCSS (Continuous Tone Coded Squelch System)
- Built-in Voice Inversion Descrambler (4,500 Hz +/- 2,000 Hz) (Not available on USA consumer version)
- Built-in APCO25 (P-25) decoder (conventional mode only)
- Built-in AFC (Automatic Frequency Control)

AM (Amplitude Modulation)

- Envelope Detection (Normal AM decoder)
- Synchronous Detection
 1. DSB (Double Side Band) synchronous
 2. SSB (Single Side Band) USB/LSB (Upper Side Band/Lower Side Band) selectable synchronous
 3. Side Band Diversity
- AGC (Automatic Gain Control) mode/Manual RF gain mode

SSB (Single Side Band)

- USB/LSB selectable
- AGC mode/Manual RF gain mode
- Sharp shape factor BPF (Band Pass Filter)

ISB (Independent Side Band)

- Simultaneously decoded LSB and USB (Stereo Output)
- AGC mode/Manual RF gain mode

CW (Continuous Wave)

- Built-in narrow band IF filters, 200 Hz/500 Hz
- CW stereo effect 200 Hz IF filter → (Right +100 Hz/-50 Hz, Left +50 Hz/-100 Hz) (,headphones required)
- Adjustable tone pitch, 600 Hz +/- 300 Hz

VIDEO

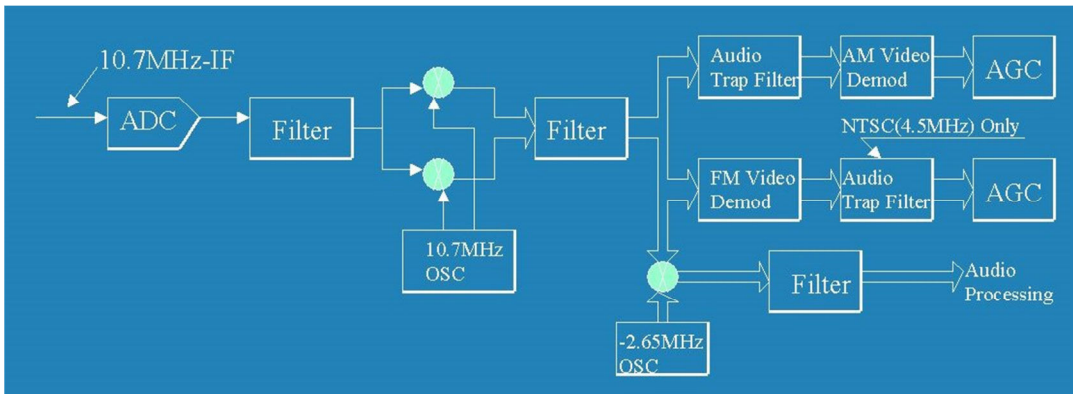

- TV reception in NTSC, PAL, or SECAM formats

RZ-SSB (Real Zero SSB)

- Decodes AM signal with FM decoder (without AGC) by using phase signal
- Effective against phasing or interference

NB (Noise Blanker)

- Operates in AM, SSB, ISB and RZSSB mode

Auto Notch Filter

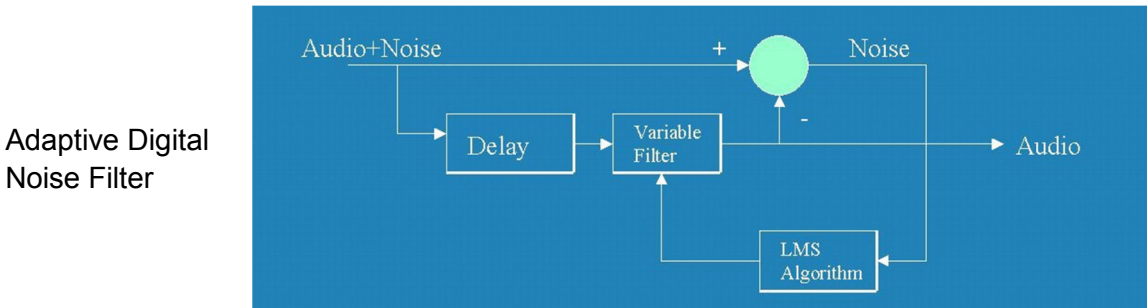

IF Shift

- Shift width: +/- 1.200 Hz
- Operates in SSB and AM modes

VSQ (Voice Squelch)

- Utilize FFT and LMS (The Least-Mean-Square) algorithm

DVR (Digital Voice Recorder)

- Records up to 25 minutes (up to 12 minutes in WFM mode)
- Captures audio up to 12 seconds prior to the start of recording

Analog output for DRM (Digital Radio Mondiale)

- 6 kHz IF (I/Q) analog output for DRM PC receiver

1-5 Controls & functions

Controls are located on the front with most connectors on the rear of the AR-ALPHA.
A brief identification is given here:

Front Panel

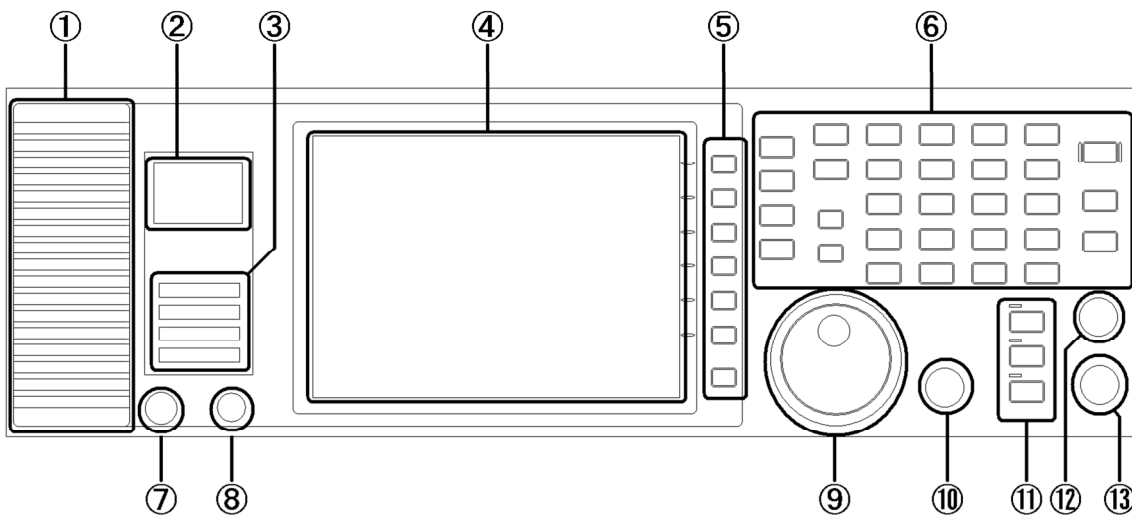

- ① Internal speaker
- ② Analog S-meter
- ③ Status Indicators
- ④ LCD screen
- ⑤ Soft Keys
- ⑥ Main control keys
- ⑦ Front accessory connector
- ⑧ Headphone Jack
- ⑨ Main Dial knob
- ⑩ Sub Dial knob
- ⑪ Sub dial keys
- ⑫ Squelch control knob
- ⑬ AF Gain (Volume) control knob

Main Control Keys

1-5-1 Keypad

Keypad conventions

Most keys have secondary functions, which are printed on the panel. However, due to the restrictions of available space, not all functions can be shown on the keypad.

The secondary functions of the AR-ALPHA are indicated with white characters above each key.

To access the secondary function, press the  key, then press the respective key.

1-5-2 Summary of keys

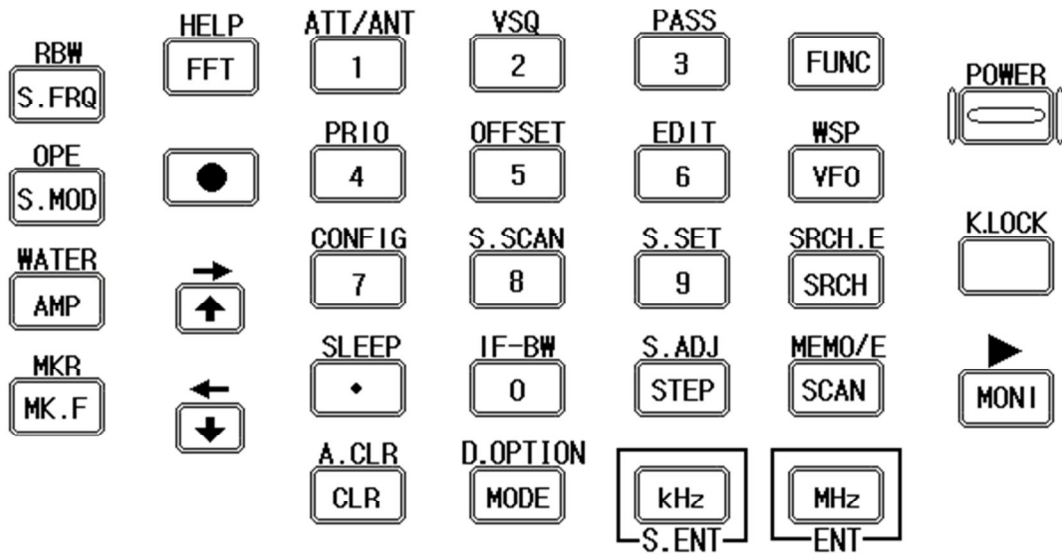

POWER

Press and hold this key for one (1) second to turn on power to the unit. After initializing, the LCD screen will appear.

To turn power off, press and hold this key for 2 seconds. A “power off” message will appear on the screen and the power to the unit will turn off.



K.LOCK



K.LOCK

Press this key when you do not wish an important frequency to be lost or the AR-ALPHA to be incorrectly set to a different frequency.

To exit from the key lock function, press and hold this key for 2 seconds.



MONI

The monitor key manually overrides the squelch so that you may monitor a weak signal.



FUNC

The function key is used to select the secondary functions of the keypad.

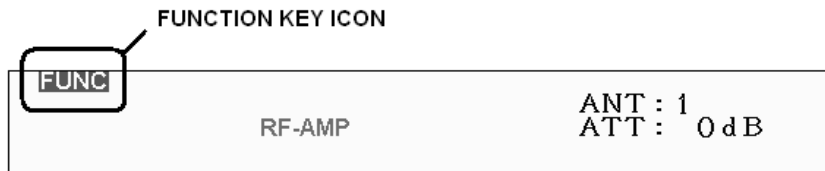

VFO / WSP

Press this key to select the **VFO** mode. There are 5 VFOs (**VFO-A** through **VFO-E**) you may access in the AR-ALPHA.

Press the  key, then press this key to enter the **WSP** (Wide Span) mode.

The **WSP** icon appears on the left of the frequency display. The AR-ALPHA can display up to 1 GHz of frequency bandwidth. To exit the WSP mode, press the VFO key.



SRCH / SRCH.E

Press this key to select the **NORMAL SEARCH** mode.

To initiate a normal search, press and hold the **SRCH** key for 2 seconds.

Press the  key, then press and hold this key for 2 seconds to enter the **Search Environment set mode**.

To exit from the **Search mode**, press the **VFO** key.

SCAN

SCAN / MEMO/E

Press this key to initiate **SCAN**.

To set the scan mode, press and hold the **SCAN** key for 2 seconds.

Press the **FUNC** key, then press and hold this key for 2 seconds to enter the **Scan Environment set mode**.

To exit from the **Scan mode**, press the **VFO** key.

MHz

MHz / ENT

Press this key to have the AR-ALPHA accept data entry.

When entering a frequency in MHz, use numeric keys followed by this key.

kHz

KHz / S.ENT

When entering a frequency in kHz, use numeric keys followed by this key.

Press this key to accept frequency step entry.

STEP

STEP/ S.ADJ

Press this key to enter frequency step.

STEP : 100.000k
00 000MHz

Press the **FUNC** key, then press this key to go into the **Frequency Step Adjust mode**.

MODE

MODE / D.OPTION

Press this key to display the receive mode selection menu. Then select the desired receive mode by rotating the **Sub Dial Knob**. Press the **MHz** key to confirm entry.

Any receive mode may be selected for any frequency within the receiver's frequency coverage range. Press and hold this key for 2 seconds to go into the Auto-Mode.

MODE select (Simple)							
WFM1	WFM2	FMST	NFM	SFM	WAM	AM	NAM
SAM	SAL	SAH	USB	LSB	CW1	CW2	ISB
SBD	RZ-S	AIQ	AUTO				

Simple Select Mode

To switch the Mode selection to “Advanced”, press the **MODE** key while the MODE select screen is displayed.

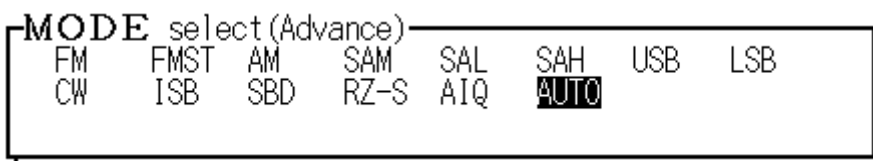

Advanced Select Mode

Press the **FUNC** key, then press the MODE key to go into the **Additional digital mode**.

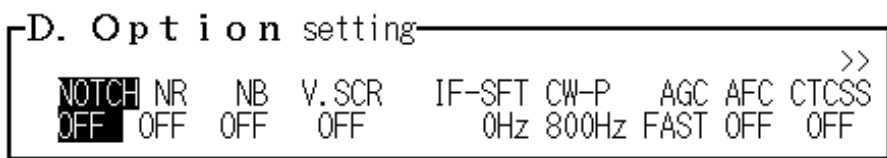

Press either the **UP Arrow key** or **DOWN Arrow key** to select the mode, and rotate the **Sub Dial knob** to change the parameter. Press the **MHz** key to confirm entry.

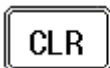

CLR / A. CLR

Press this key to cancel the entry and return to the previous screen.

During frequency entry, pressing this key will move the cursor backward to delete one digit for correction. (Same function as a backspace key)

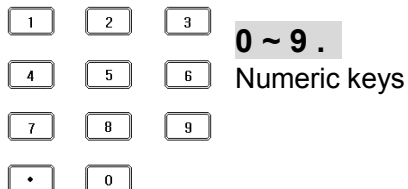

FFT / HELP

Press this key to go into the **FFT** display mode.

To exit from the **FFT** display mode, press the VFO key.

Press the **FUNC** key, then press this key to display the help menu on the screen.

To exit from the **HELP** screen, press the **VFO** key.



○ (Red circle)

Press this key to activate the DVR (Digital Voice Recorder).



UP / RIGHT

In the VFO mode:

Pressing this key will increase the receive frequency by the currently selected frequency step.

Press the  key, then press this key to increase the receive frequency by 10 times the selected frequency step.

In memory mode:

Press this key to select a higher memory channel.



DOWN / LEFT

In the VFO mode:

Press this key to decrease the receive frequency by the currently selected frequency step.

Press the  key, then press this key to decrease the receive frequency by 10 times the selected frequency step.

In the memory mode:

Press this key to select a lower memory channel.



S. FRQ / RBW

Press this key to display the spectrum display setting menu on the right corner of the LCD screen. In this mode, one the following three (3) modes can be selected.

- a. Spectrum Analyzer mode
- b. Auto Spectrum analyzer mode
- c. Channel scope mode

To cancel this operation, press the **CLR** key.

Press the  key, then press this key to access the Resolution Bandwidth Setting menu. In this mode, one the following five (5) parameters can be selected.

1 kHz, 4 kHz, 32 kHz, 64 kHz, and 128 kHz

Each function is accessible through the corresponding soft key at the right of the LCD.

To cancel this operation, press the **CLR** key.

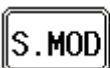

S. MOD / OPE

Press this key to display the search mode menu at the right corner of the LCD screen. In this mode, one the following two (2) modes can be selected.

1. Normal Spectrum Analyzer mode
2. Channel scope mode

To cancel this operation, press the **CLR** key.

Press the **FUNC** key, then press this key to access the Calculation menu. In this mode, one of the following three (3) calculation modes can be selected.

1. OPE. MAX (Maximum value hold)
2. OPE. AVR (Average value)
3. OPE. MED (Median)

Each function is accessible through the corresponding soft key at the right of the LCD.
To cancel this operation, press the **CLR** key.



AMP / WATER

Press this key to set the input sensitivity level of the AR-ALPHA. There are six (6) different input sensitivity levels between 0 dBm and -50 dBm in 10 dB steps.

Press this key to highlight the reference level (in reverse contrast). You may adjust the level using the sub dial knob and validate with the **MHz** key, or enter the desired value using the numeric keys.

Press the **FUNC** key, then press this key to select the waterfall display feature.

To exit the waterfall display, press the AMP key followed by the FUNC key.



MK. F / MKR

Press this key to designate the marker frequency as the center frequency.

Press the **FUNC** key, then press this key to access the marker setting menu. In this mode, one of the following three (3) calculation modes can be selected.

1. Marker frequency reading
2. Peak marker reading
3. Continuous peak reading

Each function is accessible through the corresponding soft key at the right of the LCD.

To cancel this operation, press the **CLR** key.

Squelch knob and AF Gain knob

SQUELCH KNOB

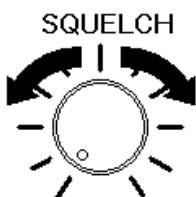

Turn this knob clockwise until background noise disappears.

AF GAIN KNOB



Turn clockwise to increase audio (speaker) output level and turn counterclockwise to decrease audio (speaker) output level.

Sub Dial Keys

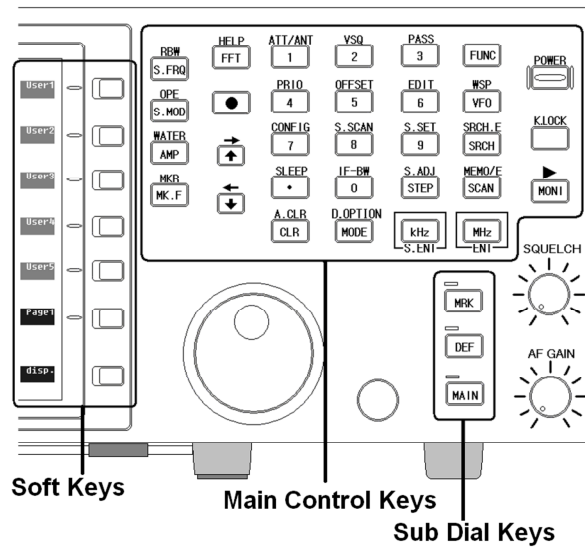

MKR

Pressing this key will illuminate a red lamp above the **MKR** switch.

When the AR-ALPHA is in the VFO mode or Memory mode and the LCD is displaying frequency spectrum, the frequency marker cursor on the LCD screen can be moved by rotating the sub dial knob (small knob to the left of this key).

While the MKR lamp is illuminated, pressing this key again will make the red lamp flash and increase the cursor speed 10 times faster than normal. Press this key again to return to the normal rate.

When the video screen is displayed, this function is disabled.

While in the Search mode, Memory Scan mode, and Select Scan mode, the sub dial knob is used to select the respective bank.



DEF

Pressing this key will illuminate a green lamp above the **DEF** switch.

When the AR-ALPHA is in the VFO mode, rotating the sub dial will change the receive frequency by the preset frequency step. To change the frequency step, while the green lamp is lit, press this key again. The sub dial frequency step setup screen will appear.

Using the numeric keypad, enter the desired frequency step followed by **kHz** key.

To cancel the entry, press this key again.

When the video screen is displayed, this function is disabled.

While in the Search mode, Memory Scan mode, and Select Scan mode, the sub dial knob is used to select the respective bank.



MAIN

Pressing this key illuminates an orange lamp above the **MAIN** switch.

When the AR-ALPHA is in the VFO mode, the function of the sub dial is the same as the main dial.

While the MAIN lamp is illuminated, press this switch again until the orange lamp flashes; this enables the sub dial to change the receive frequency 10 times faster than the main dial.

Press this key again to return to the normal tuning speed.

While in the Search Mode, Memory Scan mode, and Select Scan mode, the sub dial knob is used to select the respective bank.

	Lit	Rotate the sub dial to move the marker display line.
	Flash	Press and hold this key until the MKR-LED flashes. This enables the marker to move 10 times faster than its normal speed.
	Lit	The frequency step changes with the designated steps.
	Flash	Press and hold this key; a small window will appear on the LCD screen. This enables setting the frequency step using the sub dial.
	Lit	The sub dial operates the same as the main dial.
	Flash	Press and hold this key until the MAIN-LED flashes. Rotating the sub dial changes the receive frequency at 10 times the rate of the main dial.

Dial Knobs

SUB DIAL (Small knob)



The sub dial knob is used to change the parameters of various settings or to change the memory bank.

MAIN DIAL (Large Knob)

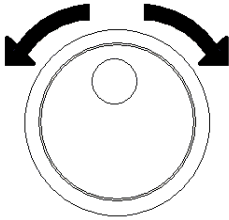

In the VFO mode, rotating this knob will change the receive frequency.
 In the Memory Mode, rotating this knob will change the memory channel. (To change the memory bank, rotate the sub dial knob.)

In the Search mode, the Memory Scan mode, and the Select Scan mode, this knob is used to change the search/scan direction.

Soft Keys

There are seven (7) keys at the right of the LCD display; they are called “Soft Keys.”
 The bottom key is designated as the DISPLAY KEY. Unlike the other 6 soft keys, the display key is mostly used to control the functions of the LCD screen.
 The functions of the soft keys vary according to the function displayed on the LCD screen.
 The soft keys may also be used for user-defined functions depending on the displayed contents.

Display example of Page 1 and Page 2 in VFO mode

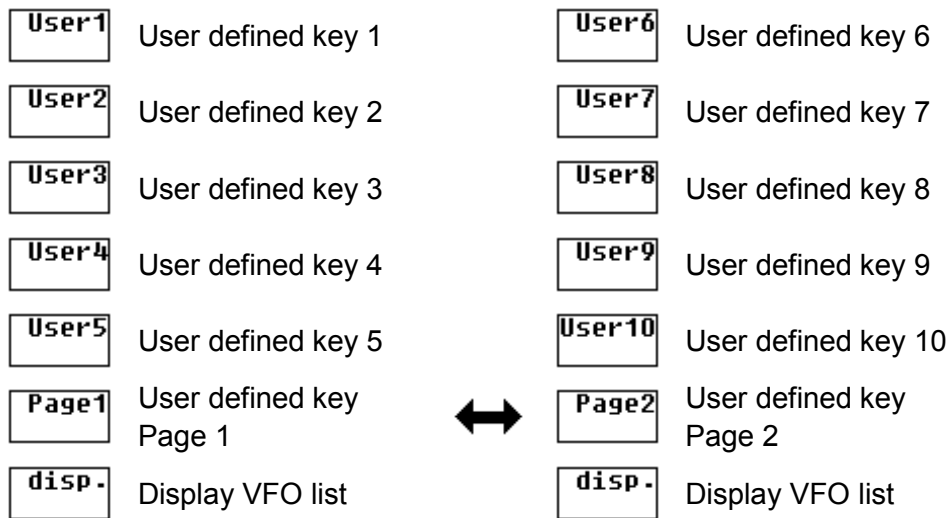

Below are the functions of the soft keys. When no description of a key is shown, there is no assigned function for the soft key in that mode.

When a soft key function is displayed in a dark blue color, it is not selectable.

Normal	SRCH	FFT	S.FR	S.MOD	ATT/ANT	S.SCAN	RBW	OPE
User1	PASS List		START Freq.	S.MOD SPECT	Amp ON Att 0		RBW 1kHz	OPE MAX
User2		select Bank	END Freq.		AmpOFF Att 0		RBW 4kHz	OPE AUR
User3	UFO-D Set	select Step	CENTER Freq.	S.MOD CHANL	AmpOFF Att 10	MemCh Read	RBW 32kHz	OPE MED
User4	Newest Cursor	select Thre.	Spect. SPAN		AmpOFF Att 20	Newest Cursor	RBW 64kHz	
User5			Spect. STEP				RBW 128kHz	
Page1	List Clear	Search Start			AUTO ON	List Clear		
disp.	disp.	disp.				disp.		

S-METER & STATUS INDICATORS

S-METER

The analog S-meter indicates the relative level of antenna input signal.

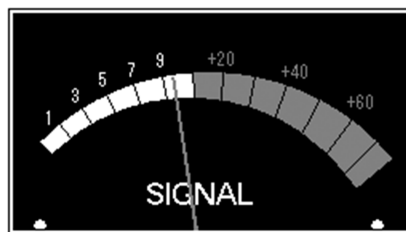

BUSY

Lit when the squelch is open.

AUTO

Lit when the AR-ALPHA is in automatic reception mode (AM, WFM, etc...).

REMOTE

Lit when the AR-ALPHA is controlled by a PC through the REMOTE 1 or REMOTE 2 connectors. While the REMOTE indicator is lit, all functions (except AF GAIN and SQUELCH CONTROL) are disabled

I/Q

Lit while I/Q signal is being sent through the USB port.

ACC1

This connector is used for an external device such as the optional CR5000 recording cable.

	1	12V DC output (30mA maximum)	5	Control 2 (for CR5000)
	2	Detector output	6	Audio output (High level) (330mV r.m.s. at 600 Ω)
	3	Audio input	7	Audio output (Low level) (2.5mV r.m.s. at 600 Ω)
	4	Control 1 (for CR5000)	8	Ground (or earth)

HEADPHONES

Use a 1/4 inch stereo type plug. When a headphone is connected, the internal speaker is disabled.



- 1 Ground
- 2 Audio output (Right)
- 3 Audio output (Left)

Secondary functions of numeric keys

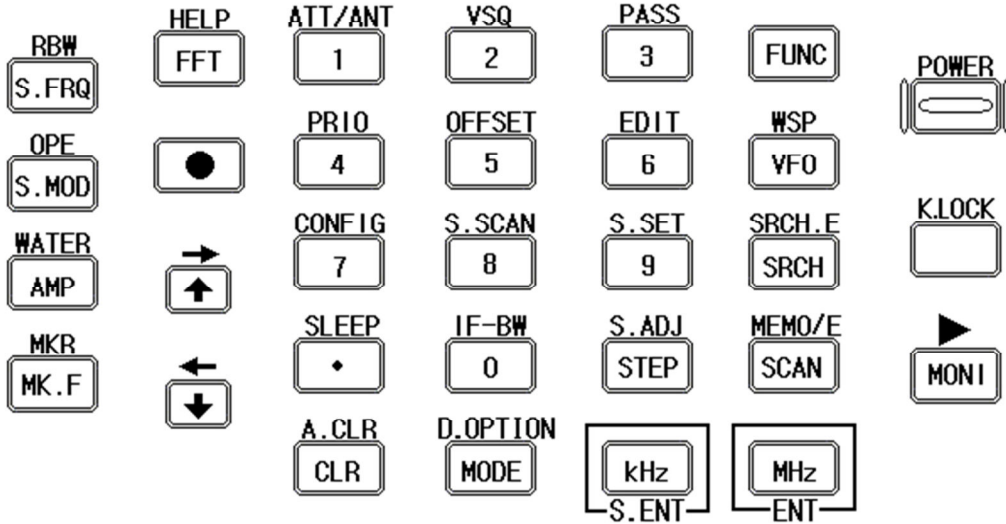

(1)

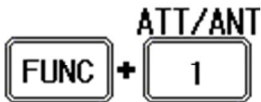

Press the key, then press the 1 key.

Selecting the attenuation level

A soft key menu will appear at the right side of the LCD.

On this screen menu, choose one of the following five (5) selections.

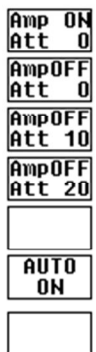

1. RF AMP: ON, Attenuator: 0 dB
2. RF AMP: OFF, Attenuator: 0 dB
3. RF AMP: OFF, Attenuator: 10 dB
4. RF AMP: OFF, Attenuator: 20 dB
5. AUTO setting

Press the desired soft key to choose the desired setting.

When AUTO is selected, the **ATT** character on the LCD will be displayed in yellow.

Selecting antenna input port

Press the **FUNC** key, then press and hold the **1** key for 2 seconds

A soft key menu will appear at the right side of the LCD.

On this screen menu, choose one of the following four (4) selections.



An optional AS5001 (or former AS5000) antenna switch is required to use more than 2 antenna inputs.

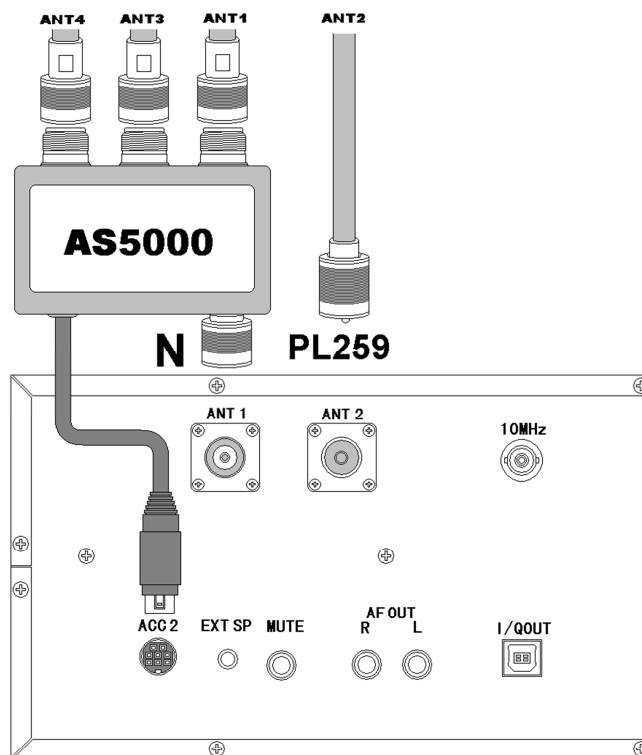

(2)

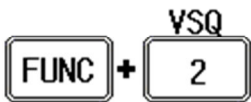

Press the **FUNC** key, then press the **2** key.

Selecting the squelch mode

Performing the above steps will toggle between the **Level Squelch Mode** and **Voice Squelch Mode**. The **VSQ** icon appears at the top left on the LCD while in the **Voice Squelch Mode**.

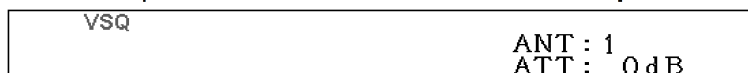



In the **Level Squelch Mode**, the squelch level is adjusted by rotating the squelch knob. Turning fully counterclockwise will disable the squelch function. Normally, turn the squelch knob clockwise until background noise disappears.

In the **Voice Squelch Mode**, the AR-ALPHA automatically analyzes demodulated voice signals and opens the squelch only when it detects human voice. Voice Level Squelch is available in the VFO mode, Search Bank mode, and Memory Channel mode.

The **BUSY** indicator located below the S-meter will light while the squelch is open.

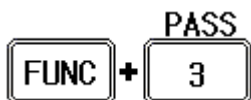
(3)



Press the  key, then press the **3** key.

Search Frequency Pass

When the AR-ALPHA receives a signal and stops searching In **Search Receive Mode**, performing the above steps will register the frequency as a “pass” frequency and resume searching. The AR-ALPHA will not stop at a pass frequency during future search cycles.

Up to 50 pass frequencies can be registered on each search bank.

The registered search frequencies can be viewed or deleted during search operations on the LCD screen.

(4)

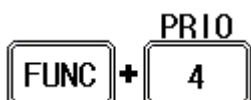

Press the  key, then press the **4** key.

Priority Function

After the priority channel is set, performing the above step will start priority receive.

The **PRIO** icon appears at the top left of the LCD while the priority function is activated.



Priority Channel Setting

Press the  key, then press and hold the **4** key for 2 seconds.

By performing the above steps, the priority setting screen will appear on the LCD.

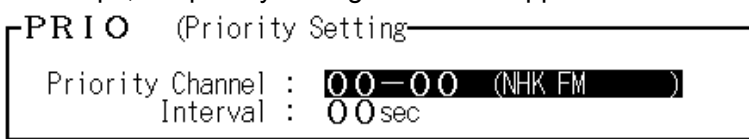

1. Rotate the sub dial to select or set the desired priority channel.
2. Press the down arrow key to move the cursor downward.
3. Rotate the sub dial to set the priority time interval between 1 ~ 99 seconds.
4. Press the **MHz** key to confirm entry.

(5)

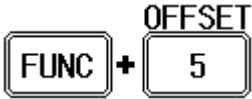

Press the  key, then press the **5** key.

Frequency Offset Function

After the offset frequency is set, performing the above step will activate the frequency offset function. Repeating the above steps will toggle this function. While the frequency offset function is activated, the **DUP** (Duplex) icon will appear at the top left of the LCD screen.

To disable this function, perform the above steps, then set the offset channel to “+00” and press the **MHz** key.

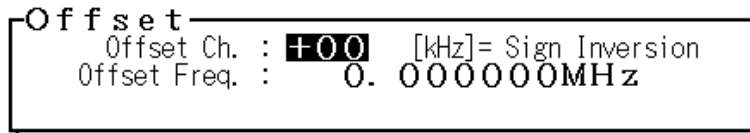

A total of 48 offset channels are available and 01 ~ 20 channels out of 48 are user programmable.

(6)

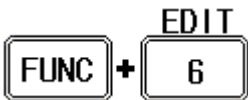

Press the  key, then press the **6** key.

Data Edit Function

Performing the above steps will display the data editor screen. In this mode, Memory bank and search bank memory channel data can be edited on the LCD screen.

To exit this function, press the **MHz** key.

(7)

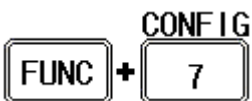

Press the  key, then press the **7** key.

Configuration Setting

The receiver's configuration can be set on this screen.

To exit this function, press the **MHz** key.

(8)

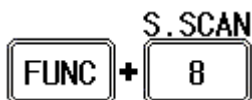

Press the  key, then press the **8** key.

Select Memory Scan Setting

Performing the above steps will activate the select scan mode. The select scan function scans each memory channel regardless of memory bank selection.

To exit from this function, press the **VFO** key.

(9)

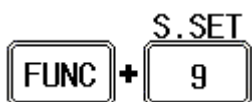

Press the  key, then press the **9** key.

Select Memory Scan Setting

This function is available only in the memory channel receive mode.

While in the memory channel receive mode, performing the above steps will transfer the current memory channel to the select memory. At the same time the **SEL** icon will be displayed on the LCD indicating the current memory channel has been registered to the select memory channel. If the registered memory channel is already registered, then the select memory channel will be deleted.

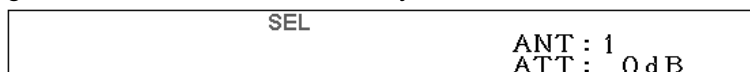

To exit this function, press the **VFO** key.

(10)

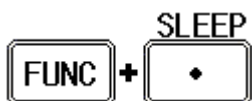

Press the  key, then press the **decimal** key.

Sleep Timer Setting

Performing the above steps will activate the sleep timer function. The time counter and the clock icon appear at the top right of the LCD.



The sleep timer can be set for up to 99 minutes in 1 minute increments.

To set the timer, rotate the **sub dial**.

To deactivate the sleep timer function, set the timer to **0**.

To exit from this function, press the **CLR** key.

(11)



Press the **FUNC** key, then press the **0** key

IF Bandwidth Setting

Performing the above steps will display the IF Bandwidth setting screen on the LCD.

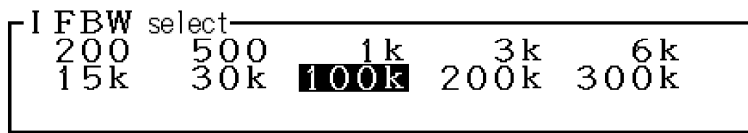

There are 10 bandwidth parameters and the selectable parameters are displayed in white.

Rotate the **sub dial knob**, then press the **MHz** key to confirm entry.

Rear Panel

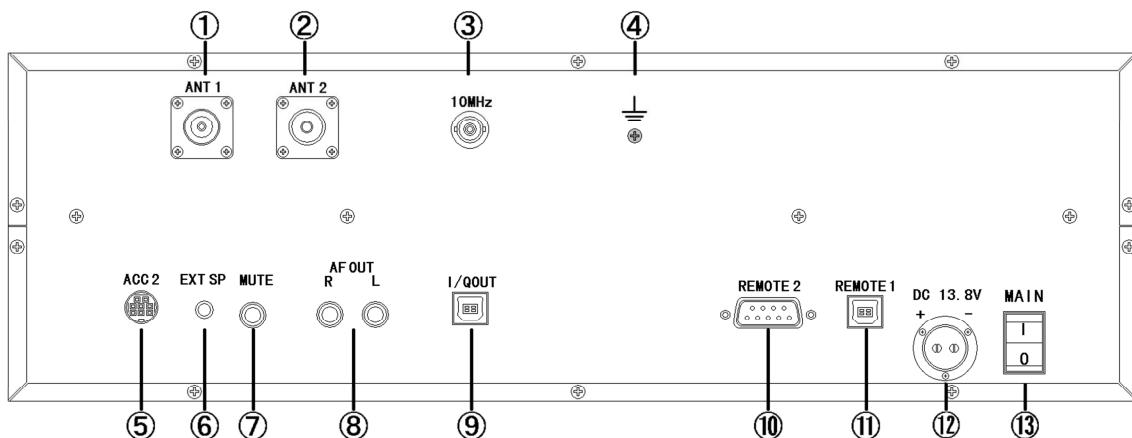

1. ANT 1 Connector



N type connector. Antenna impedance is 50 Ω nominal. An optional AS5001 antenna relay switch can be connected to this connector.

2. ANT 2 Connector



SO-239 type connector. Antenna impedance is 50 Ω nominal.

3. 10 MHz Input Connector



External 10 MHz reference signal input connector (BNC)

4. Ground (or Earth) Terminal



5. ACC 2 Connector

	1	12V DC output (50mA max.)	5	Antenna switch A
	2	10V DC output (50mA max.)	6	Antenna switch B
	3	AGC 4.5V ~ 3.0V	7	No connection
	4	No connection	8	Ground

An optional AS5001 antenna relay switch may be connected here.

6. EXT (External) Speaker Jack

3.5 mm mono jack for an external speaker (impedance 8 Ω). When an external speaker is connected, the internal speaker will be disabled.

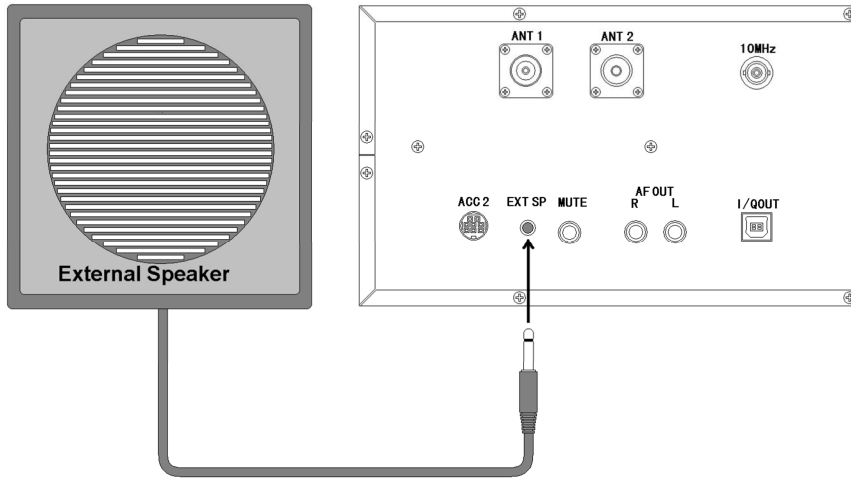

7. MUTE Jack
MUTE



Connecting the center pin to ground will mute the receiver.

8. AF OUT Jack
AF OUT
R L



Line output for stereo audio. An external amplifier can be connected to these RCA type jacks.

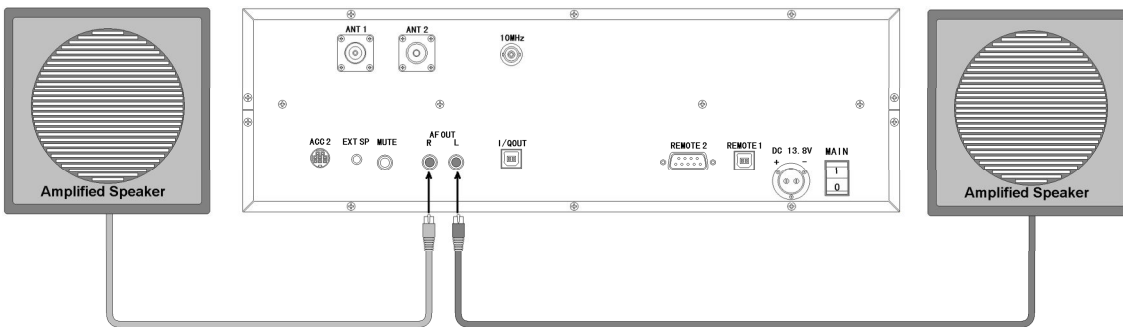

9. I/Q OUTPUT Connector
I/QOUT



USB 2.0 compatible I/Q data output of 300 kHz or 1 MHz selectable bandwidth. You need to install the AOR IQ driver provided on the CD, or download it at www.aorja.com.

10. Remote 2 Interface Connector REMOTE 2

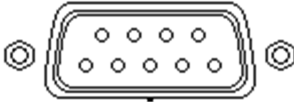

The REMOTE RS-232C connector is designed for connection directly to the RS-232C serial port of a PC. No interface is required, a standard RS-232C straight cable is all that is necessary. Connections for a PC are as follows:

AR-ALPHA	DB-9 RS-232C cable
Pin # 2	Pin # 2
Pin # 3	Pin # 3
Pin # 5	Pin # 5 (Ground)
Pin # 7	Pin # 7
Pin # 8	Pin # 8

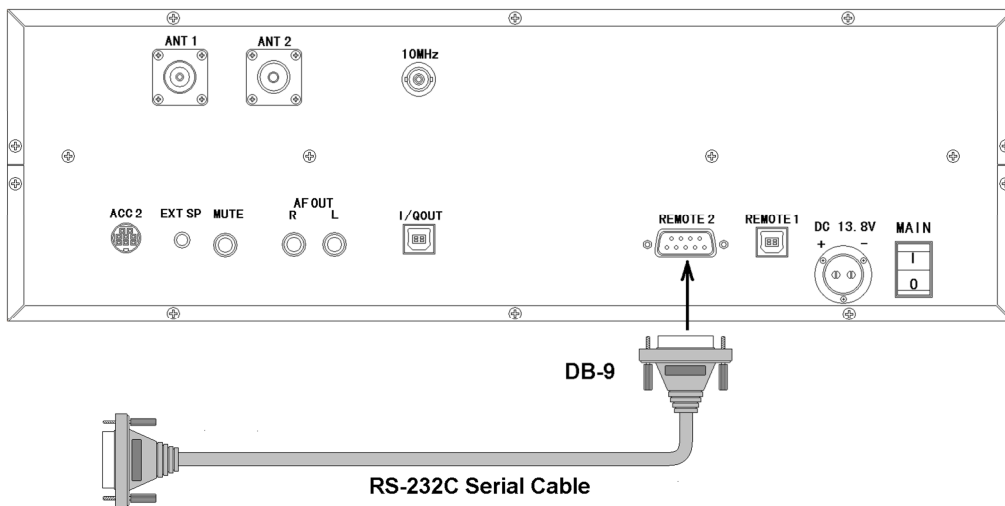

11. USB Connector REMOTE 1



The USB connector is designed for connection directly to the USB port of a PC.

The RS-232C serial port and the USB port cannot be used at the same time.

Use either the USB driver program provided on the CD, or downloaded from the following URL.

<http://www.ftdichip.com/ftdrivers.htm>

Click "VCP Drivers", then select the device number "FT232B".

12. Power Input Connector

DC 13.8V

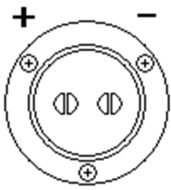

Using the supplied DC power cable, apply regulated 13.8V DC (min 2.2A) power to the AR-ALPHA. The polarity is clearly marked. Avoid reverse polarity.

13. Main Power Switch

MAIN

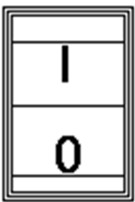

Main power switch. This switch must be always turned on for normal use.

2 Getting started

2-1 Preparing the AR-ALPHA for operation

2-1-1 Connect the antenna

For reception, connect the antenna to either Antenna 1 or Antenna 2 on the rear panel of the AR-ALPHA. Usually, for signal reception below approximately 1 GHz, connect the antenna to the Antenna 2 connector (SO-239 type connector).

Check the OPTIONAL ACCESSORIES chapter regarding the most suitable antennas according to the frequency range you intend to receive.

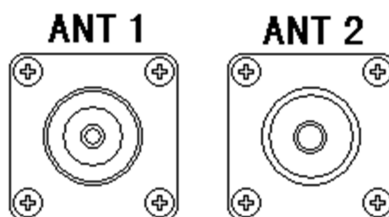

2-1-2 Connect power

Connect power to the DC power jack on the rear panel of the AR-ALPHA. Always use a regulated DC power supply (12 ~ 14 V with 2.2A or higher). Do **not** connect to a 24 V power supply.

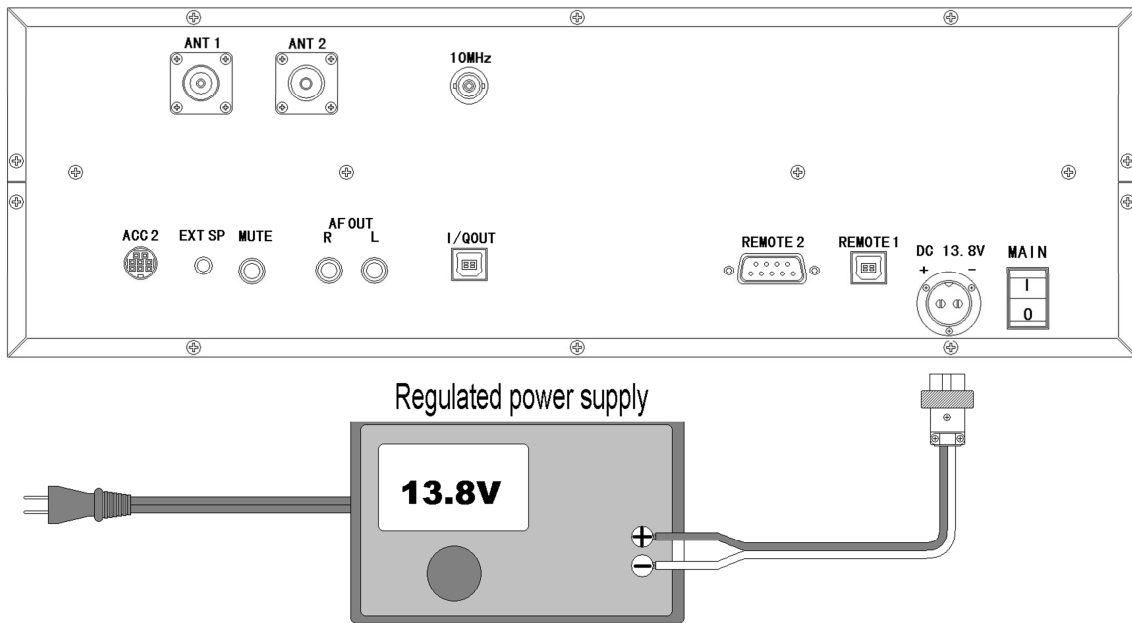

2-2 Switching On for the first time



Set the squelch control to the 'mid-point'.

Turn on the main power switch on the rear panel of the AR-ALPHA.

Press the power switch at the top right of the front panel. Allow a couple of seconds for initializing, then the S-meter will light. Then rotate the AF GAIN (volume) control knob to the 'mid-point'.



Please be careful - DO NOT switch on the AR-ALPHA while wearing headphones connected to the receiver; there may be an audible click when the unit is switched on, or the volume may be accidentally set too high.

The AR-ALPHA will take approximately 4 ~ 5 seconds before information appears on the LCD. This is normal, as the microprocessor of the AR-ALPHA must complete an initializing process at the beginning of a power-on cycle.

2-3 Squelch Circuit

In normal use, **LEVEL SQUELCH** is used. However, **VOICE SQUELCH** can be selected for search and scan operations. The **LEVEL SQUELCH** parameter sets the AR-ALPHA to check the signal strength of **active** frequencies and to only stop when the signal strength is above a preset level (which is programmable).

To select **LEVEL SQUELCH**, rotate the squelch knob clockwise until background noise disappears. The squelch will open only when input signal strength is above this set level.



To select **VOICE SQUELCH**, Press the **FUNC**, then press the **2** key. The **VSQ** icon will appear at the top left of the LCD screen.

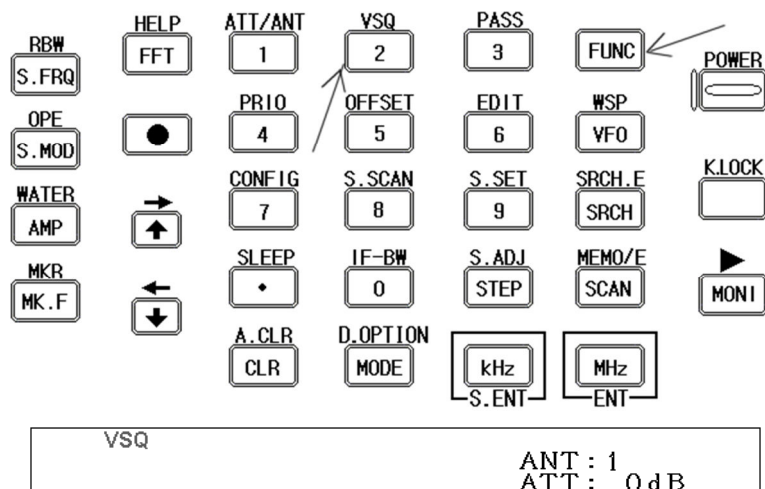

Rotate the squelch knob until background noise disappears. The Squelch will open only when the received voice audio level is above this set level. To return to **LEVEL SQUELCH**, repeat above steps.

2-4 VFO selection

The AR-ALPHA has five (5) VFOs being identified as “**VFO-A**” through “**VFO-E**” at the top left of the LCD. The term VFO stands for ‘**Variable Frequency Oscillator**’ and in modern receivers refers to stored tuneable data that contains frequency, step, step-adjust, attenuator etc. Each time **VFO** key is pressed, one of the five available VFOs (A~E) is selected.

The AR-ALPHA has an AUTOMODE setting, which in most cases automatically selects the proper receive mode, and frequency step.

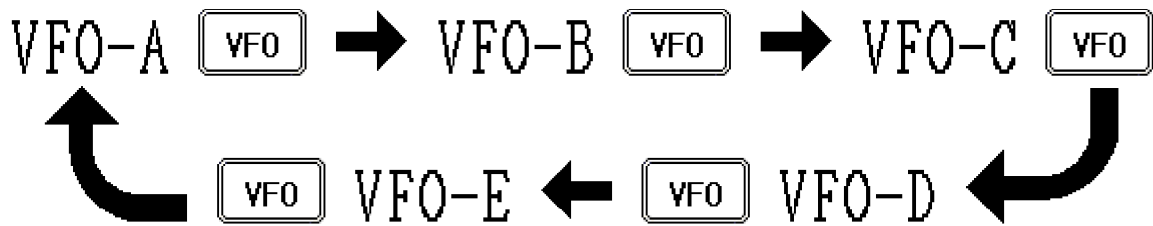

● **Direct VFO select**

- To select **VFO-A**, press the key, then press the key.
- To select **VFO-B**, press the key, then press the key.
- To select **VFO-C**, press the key, then press the key.
- To select **VFO-D**, press the key, then press the key.
- To select **VFO-E**, press the key, then press the key.

● **Select from the VFO LIST**

Press the soft key.

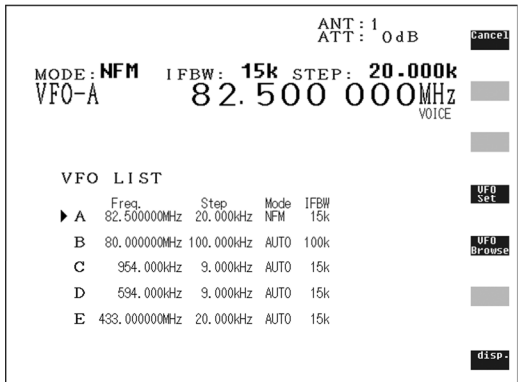

The VFO LIST screen will appear.

Using key or key, select the desired VFO.

Press the soft key to confirm entry.

2-4-1 Tuning frequency

2-4-1-1 Entering a frequency using the numeric keypad

While in the **VFO** mode, enter the desired frequency followed by the **MHz** key or **kHz** key.

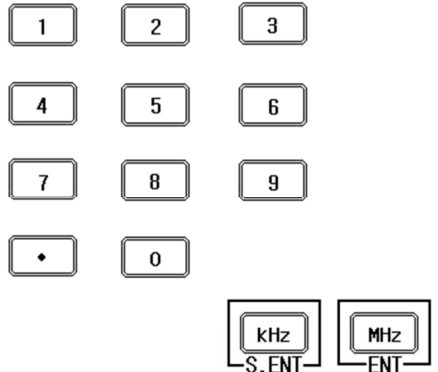

Example of frequency entry for 162.55 MHz

Press the [1] key, [6] key, [2] key, [.] key, [5] key, and [5] key.
Press the [MHz] key.

Example of frequency entry for 954 kHz (0.954 MHz)

Press the [9] key, [5] key, and [4] key.
Press the [kHz] key.

Editing frequency input

If there is an error during frequency input, press the **CLR** key. The frequency cursor will move backward and delete the last digit entry. Re-enter the correct number from the numeric keypad.

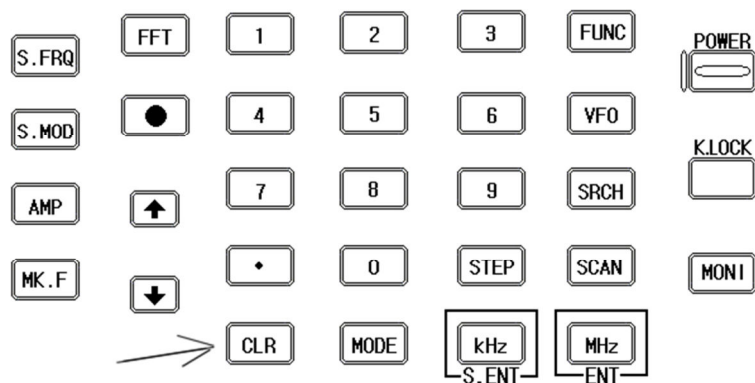

Aborting frequency input

If for some reason you do not wish to complete frequency input, press the **FUNC** key, then press the **CLR** key.

2-4-1-2 Changing frequency using the main tuning dial

While in the **VFO** mode, a VFO frequency may be selected by using the main tuning dial, located at the right side of the front panel. You may rotate the dial 'clockwise' to increase frequency or turn 'counterclockwise' to decrease frequency.

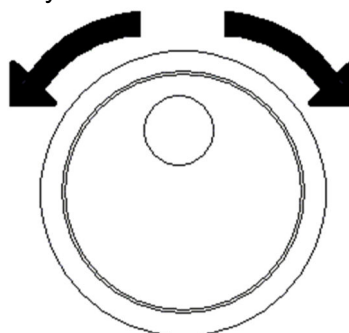

2-4-1-3 Changing frequency using UP arrow key or DOWN arrow key

The **UP** arrow key and **DOWN** arrow key provide a convenient method of changing frequencies. The speed at which the receiver steps up or down depends upon the **STEP SIZE**, which defaults to **AUTO**. In **AUTO** the step size, receiver mode etc. is taken from the factory pre-programmed band plan but it may be overridden at any time.

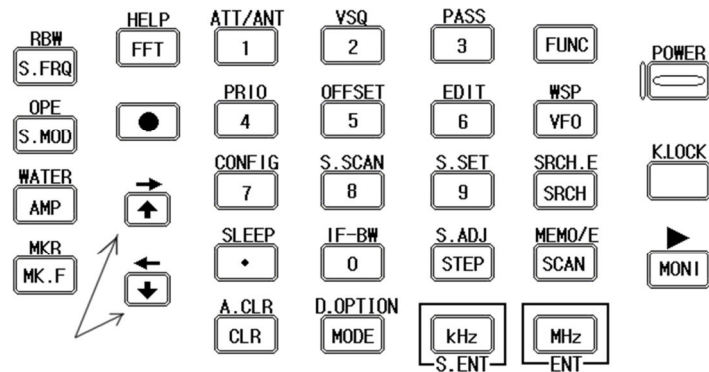

Press the **UP** arrow key to tune the receiver upward in whichever step size is selected, use the **DOWN** arrow key to tune the receiver frequency lower.

2-5 Changing receive mode

Due to the necessities of signal bandwidth, channel occupancy and transmission efficiency, different receive modes are used by various radio services. Specifications for tuning step and receive mode are allocated by government agencies but they are not consistent throughout the world. For this reason, it may be necessary to change receive modes in order to monitor various transmissions.

For your convenience, receive mode and tuning step size have been pre-programmed into the AR-ALPHA auto-mode band plan at the factory to simplify operation of the receiver. If needed, the defaults may be manually overwritten at any time so that you may select an alternative receive mode and tuning step on any frequency.

AM

Amplitude Modulation – Used by broadcast services throughout the world on long wave, medium wave and shortwave. AM is also used on the VHF airband, UHF military airband, and by some PMR (Private Mobile Radio) and utility services.

FM

There are two common types of FM (Frequency Modulation), these are:

NFM – Narrow Band Frequency Modulation – this provides high quality communication for relatively short distance operations. FM uses a wider frequency bandwidth than other modes such as SSM so it is less efficient.

NFM is the most common mode used above 30 MHz with the exception of the airbands.

NFM is widely used on the VHF bands: VHF marine band, 2m and 70 cm amateur bands, by PMR (Private Mobile Radio) and utilities. In the absence of a signal, the background noise may seem quite loud. For ease in listening, the squelch knob should be rotated clockwise until the background noise just disappears; this should be carried out while no signal is present. The point where the background noise is cancelled is known as threshold point. Do not advance the squelch control more than necessary or the receiver will appear to be desensitized and weaker signals will be missed.

WFM – Wide Band Frequency Modulation – used by VHF and UHF broadcast stations.

Excellent audio quality is apparent due to the relatively wide frequency bandwidth of the signal. Used only for local services such as VHF band stereo and UHF TV sound channels.

LSB – Lower Side Band – is a form of SSB (Single Side Band). LSB tends not to be used commercially but is extensively used by Radio Amateurs on frequencies below 10 MHz. This assists the separation of Commercial and Amateur users on traditionally shared bands.

SSB is a very efficient method of transmission as the unwanted second sideband and carrier are not present. This allows the full transmitter power to be used to convey information within the wanted sideband. As a result, long distance communications are possible on SSB in a narrower bandwidth than required for most other modes.

USB – Upper Side Band – The same comments apply as for LSB. By convention, Radio Amateurs use USB above 10 MHz.

CW - Continuous Wave – Often referred to as Carrier Wave or Morse Code. Commonly used on the short wave bands by radio amateurs toward the lower end of each band allocation. Some commercial use of CW continues but much has been replaced by satellite and automated communications.

2-5-1 Auto-mode selection

When auto-mode is in use, receive mode and tuning step size are automatically selected by the AR-ALPHA microprocessor.

To activate auto-mode or reconfirm its selection while in the **VFO** mode, press the **MODE** key.

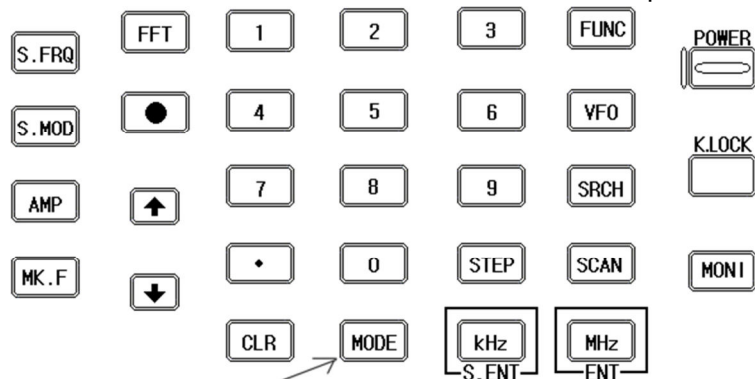

The **Mode Select** screen will appear on the LCD.

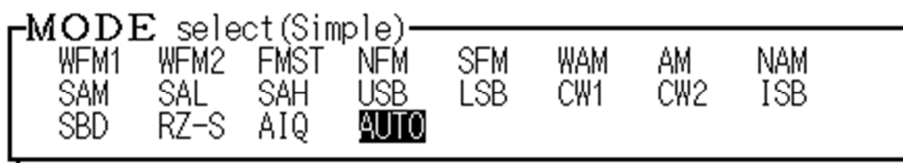

Note: The Auto-mode is cancelled as soon as the receive mode, tuning step or other related data is changed. Remember that auto-STEP and auto-MODE are linked, reselect the **AUTO-MODE** if either have been adjusted and you require the auto band plan selection.

2-5-2 Receive mode selection

The AR-ALPHA has two (2) different mode settings, **Simple Select Mode Setting** and **Advanced Select Mode setting**.

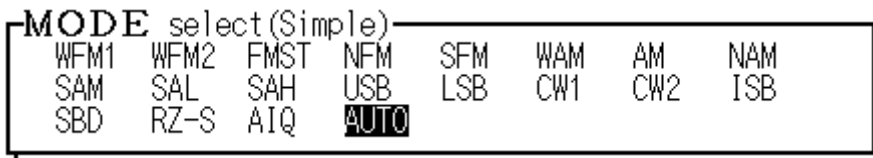

Simple Select Mode Setting

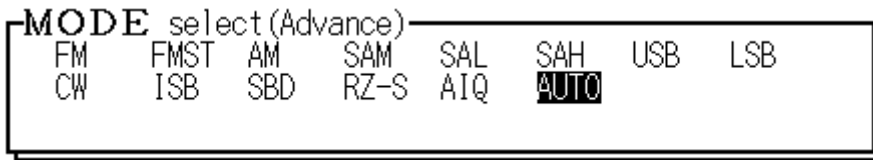

Advanced Select Mode Setting

In the **Simple Select Mode Setting**, a proper IF bandwidth is automatically selected with respect to the receive mode.

In the **Advanced Select Mode Setting**, the receive mode and the IF bandwidth can be selected independently.

To switch the Select Mode setting, press the **MODE** key while the MODE select screen is displayed. Any receive mode may be selected at any frequency within the receiver's frequency coverage range. Press and hold the **MODE** key for 2 seconds to enter the AUTO-Mode.

In the **Simple Select Mode Setting**, the following modes are available:

WFM1, WFM2, FMST, NFM, SFM, WAM, AM, NAM, SAM, SAL, SAH, USB, LSB, CW1, CW2, ISB, SBD, RZ-S, AIQ, and AUTO.

To make a selection, rotate the sub dial. To accept a selection, press the **MHz** key.

Description	Mode	IF Bandwidth (kHz)	Remarks
WFM	FM	100	Wide FM
WFM2	FM	200	Wide FM
NFM	FM	15	Narrow FM
SFM	FM	6	Super Narrow FM
WAM	AM	15	Wide AM
AM	AM	6	Normal AM
NAM	AM	3	Super Narrow AM
SAM	AM	6	Synchronous AM
SAL	AM	6	Synchronous AM (lower sideband)
SAH	AM	6	Synchronous AM (upper sideband)
USB	SSB	3	Single Sideband (upper sideband)
LSB	SSB	3	Single Sideband (lower sideband)
CW1	CW	0.5	CW
CW2	CW	0.2	CW
ISB	ISB	6	Independent Sideband
SBD	AM	6	AM Sideband Diversity
FMST	FM	200	FM Stereo
RZ-S	RZ-SSB	3	Real Zero Single Sideband
AIQ	AIQ	12+/-5	Analog IQ for DRM
AUTO	AUTO		Auto mode

In the **Advanced Select Mode setting**, the following modes are available:
FM, FMST, AM, SAM, SAL, SAH, USB, LSB, CW, ISB, SBD, RZ-S, AIQ, and AUTO.

To make a selection, rotate the sub dial. To accept the selection, press the **MHz** key.

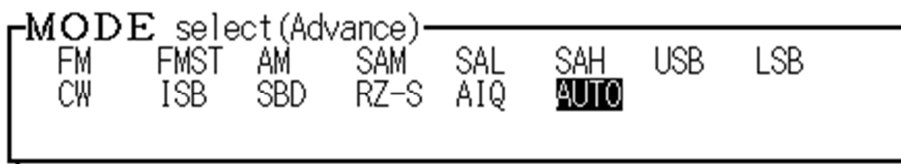

Description	Mode	Remarks
FM	FM	Normal FM
FMST	FM	FM Stereo
AM	AM	Normal AM
SAM	AM	Synchronous AM
SAL	AM	Synchronous AM (lower sideband)
SAH	AM	Synchronous AM (upper sideband)
USB	SSB	Single Sideband (upper sideband)
LSB	SSB	Single Sideband (lower sideband)
CW	CW	Normal CW
ISB	ISB	Independent Sideband
SBD	AM	AM Sideband Diversity
RZ-S	RZ-SSB	Real Zero Single Sideband
AIQ	AIQ	Analog IQ for DRM
AUTO	AUTO	Auto mode

Selectable IF Bandwidth

Description	IF Bandwidth	Remarks
200	200Hz	Available on CW mode only
500	500Hz	Available on CW mode only
1K	1 kHz	
3K	3 kHz	
6K	6 kHz	
15K	15 kHz	
30K	30 kHz	
100K	100 kHz	Available on WFM, FMST mode only
200K	200 kHz	Available on WFM, FMST mode only
300K	300 kHz	Available on WFM, FMST mode only

2-5-3 Additional decoding modes

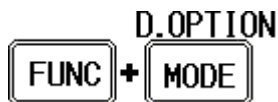

Press the **FUNC** key, then press the **MODE** key.

The **D.Option** setting sub menu screen will display on the screen.

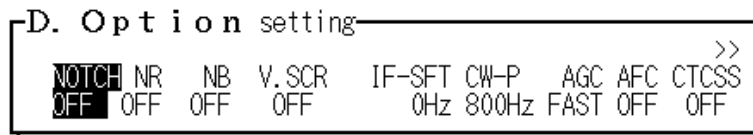

Use the **↑** key or **↓** key to select the desired decoder function.



To change the setting, rotate the sub dial, then press the **MHz** key.

After the setting is completed, the confirmation screen (see below) will appear.

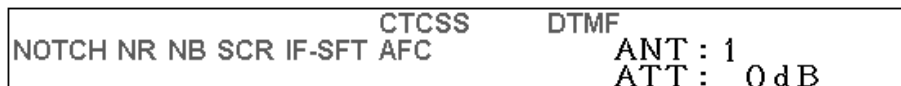

Items	Description	Parameters
NOTCH	Auto Notch Filter Tone Eliminator	OFF, LOW, MID, HIGH
NR	Noise Reduction	OFF, LOW, MID, HIGH
NB	Noise Blanker	OFF, LOW, MID, HIGH
SCR	Analog voice descrambler	OFF, 2000Hz~7000Hz (10Hz step)
IF-SFT	IF Shift	0Hz(OFF),-1200Hz~1200Hz, (50Hz step)
CW-Pitch	CW Pitch Control	300Hz~900Hz (50Hz step)
AGC	Automatic Gain Control	SLOW / MIDDLE / FAST
AFC	Automatic Frequency Control	ON / OFF
CTCSS	Tone Squelch	OFF, ALL, 60.0Hz~254.1Hz (52 tones)
DCS	Digital Code Squelch	OFF, ALL, 017~754 (106 codes)
DTMF	DTMF Decoder	ON / OFF

CTCSS (Continuous Tone Controlled Squelch System)

OFF	ALL	60.0	67.0	69.3	71.9	74.4	77.0	79.7	82.5
85.4	88.5	91.5	94.8	97.4	100.0	103.5	107.2	110.9	114.8
118.8	120.0	123.0	127.3	131.8	136.5	141.3	146.2	151.4	156.7
159.8	162.2	165.5	167.9	171.3	173.8	177.3	179.9	183.5	186.2
189.9	192.8	196.6	199.5	203.5	209.5	210.7	218.1	225.7	229.1
233.6	241.8	250.3	254.1						

CTCSS tone frequencies (in Hz)

DCS (Digital Coded Squelch)

The DCS system uses 23 bit code data sent lower than the voice band frequency. The data speed is 134.3 bit/sec in NRZ (Non-Return-Zero) format FM modulation.

OFF	ALL	017	023	025	026	031	032	036	043
047	050	051	053	054	065	071	072	073	074
114	115	116	122	125	131	132	134	143	145
152	155	156	162	165	172	174	205	212	223
225	226	243	244	245	246	251	252	255	261
263	265	266	271	274	306	311	315	325	331
332	343	346	351	356	364	365	371	411	412
413	423	431	432	445	446	452	454	456	462
464	465	466	503	506	516	523	526	532	546
565	606	512	624	627	631	632	654	662	664
703	712	723	731	732	734	743	754		

DCS Codes

DTMF (Dual-Tone Multi-Frequency)

		High Frequency (Hz)			
		1209	1336	1447	1633
Low	669	1	2	3	A
	770	4	5	6	B
(Hz)	852	7	8	9	C
	941	*	0	#	D

DTMF frequency matrix

2-6 Changing tuning STEP size

The specification for channel occupancy, step (separation) and mode are regulated and allocated by government agencies in accord with international agreements.

The allocation of frequency bands is not the same all over the world and channel separation (step) varies from band to band. As an example, the channel separation (step) for the MW (medium wave) band in the U.S.A. is 10 kHz while in Europe and Japan, it is 9 kHz.

For the above reasons, it is necessary to change the tuning step size according to local band plans. The AR-ALPHA has been pre-programmed at the factory with most of the band plan data (selectable

between Japan, Europe and the USA) so that the AR-ALPHA will automatically select the appropriate tuning step size and mode for the frequency chosen. This greatly simplifies operation of the AR-ALPHA. The factory pre-programming of step size can be manually overwritten so you may choose alternative settings at will, or when band plans are updated.

To change the default tuning step size, press the **STEP** key. The frequency step will be highlighted at the top right of the LCD (in reverse color), showing it is ready to accept a new parameter setting.

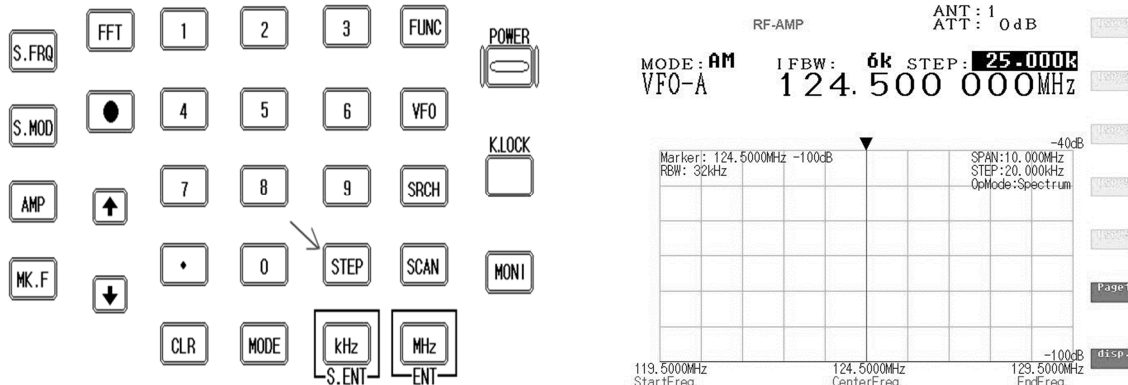

For your convenience, the following tuning step frequencies have been preprogrammed at the factory:
1, 5, 10, 50, 100, 500Hz, 1, 2, 5, 6.25, 8.333, 9, 10, 12.5, 20, 25, 30, 50, 100, 500 kHz

Rotate the **sub dial** to select the desired receive step. To accept the displayed tuning step size, press the **MHz** key.

The tuning step size may also be programmed in 1 Hz increments (via the keypad) so that unusual step sizes other than those stated are possible. The acceptable step size range is between 1 Hz and 1 MHz in 1 Hz steps. Using the numeric keypad, enter the desired tuning step frequency in kHz. Then press the **MHz** key to confirm entry.

2-7 IF Bandwidth

The IF bandwidth feature specifies how **SELECTIVE** the receiver will be when monitoring signals. However, it is not simply a case of using the narrowest filter at all times. Particular modes require sufficient amounts of bandwidth in order to operate, otherwise the received signal may not produce intelligible sound.

The correct receive mode and IF bandwidth must always be selected for optimum reception. If the bandwidth selection is too narrow, distortion or signal break-up may occur. If the bandwidth selection is too wide, adjacent interference may be encountered.

For this reason, a selection of commonly used IF filter bandwidths are pre-programmed. Typical examples of receive mode and IF bandwidth are:

- 300 kHz** -- VHF FM broadcast
- 200 kHz** -- VHF FM broadcast
- 100 kHz or 30 kHz** – Wireless microphone, etc. (example: 30 KHz for satellite FAX)
- 15 kHz** – PMR, amateur band, etc. FM 6 KHz may also be used
- 6 kHz** – VHF/UHF airband, short wave broadcast, medium & long wave, PMR, etc.
- 3 kHz** – Short wave amateur band SSB, short wave utility such as oceanic airband etc.
- 1 kHz, 500 Hz, 200 Hz** – Morse code used by radio amateurs and some marine traffic on SW.

An appropriate IF filter is automatically selected in the AUTO MODE. However any combination of IF filter and receive mode is possible in the manual mode. When you have manually selected an IF filter bandwidth, AUTO MODE will be deactivated, but the receive mode, step size, etc. will be retained until they are changed manually.

2-7-1 Manually selecting IF bandwidth

Press the **FUNC** key, then press the **0 (zero)** key.

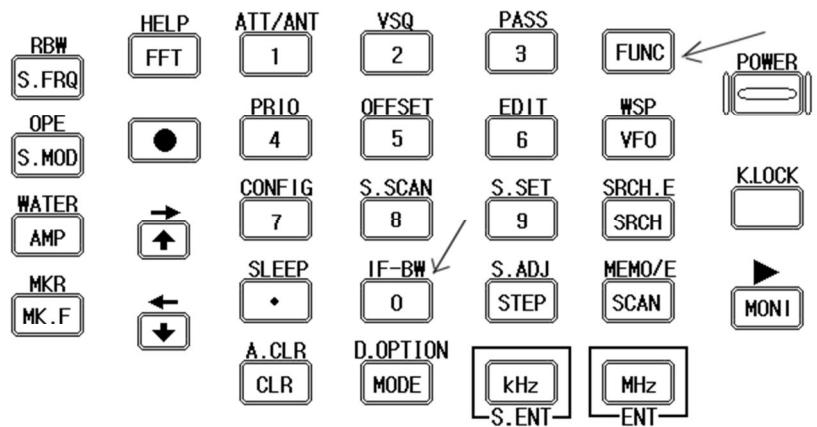

The IF Bandwidth (IFBW) select screen will appear on the LCD.

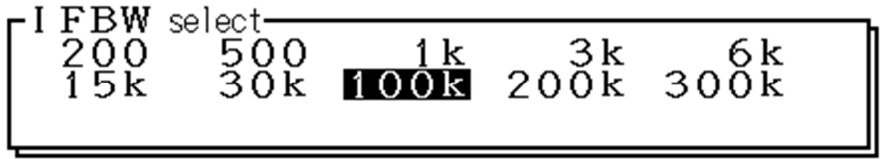

Select a new bandwidth from the list of 200, 500 Hz, 1, 3, 6, 15, 30, 100, 200, and 300 kHz by rotating the sub dial key. The selectable IF bandwidth is displayed in white. Other parameters may be selected (displayed in blue), however, they may not be suitable for the particular receive mode in use.

To accept the new bandwidth selection, press the **MHz** key.

2-8 ATTENUATOR

Activating the attenuator reduces signal to the RF input stages of the AR-ALPHA to prevent overloading in cases where the receiver is used in close proximity to strong transmissions.

The AR-ALPHA has five settings for **ATT** (attenuator), **AMP ON 0 dB**, **AMP OFF 0 dB**, **10 dB**, **20 dB** and **AUTO**.

To change the **ATT** parameter setting, press the **FUNC** key, then press the **1** key.

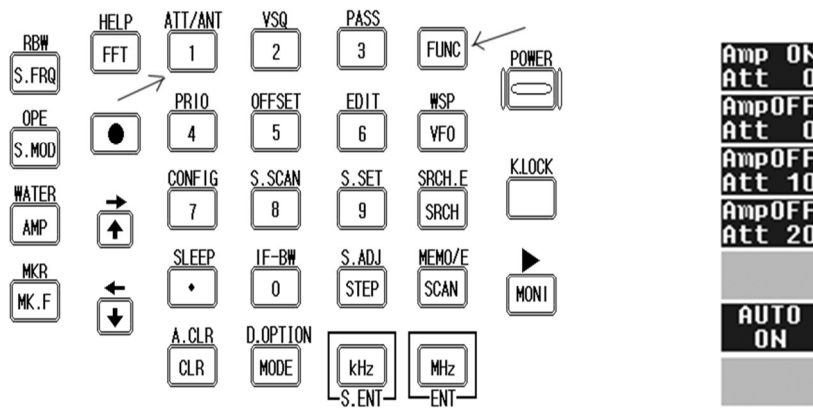

2-9 OFFSET

This function enables the receive frequency to be quickly SHIFTED by a predetermined value; this makes it easy to track duplex-transmissions or check repeater inputs/outputs. Frequency offset may also be programmed manually.

The locations for frequency offset storage are numbered 00 to 47 with 00 acting as OFF, and the first 20 offsets are user programmable. The rest are used for quick offset memories.

Frequency offset may be programmed into VFO, memory channel and search banks. It is most convenient to set-up in the VFO mode, then save the data to a specific memory channel for quick recall at a later time. Frequency offset is primarily designed for memory channel use, as it is a rather complex process to toggle on/off in the VFO mode. However when programmed, frequency offset is not detrimental to normal operations.

The acceptable range of frequency offset is 0 MHz to 999.999999 MHz. Of course if the offset is set to 0 MHz, the frequency will not change. Before the FREQUENCY OFFSET function can be used, it first needs to be configured (unless it is already factory programmed for certain bands).

2-9-1 Using pre-programmed frequency offset data

To access the frequency offset set-up menu, press the **FUNC** key, then press the **5** key.

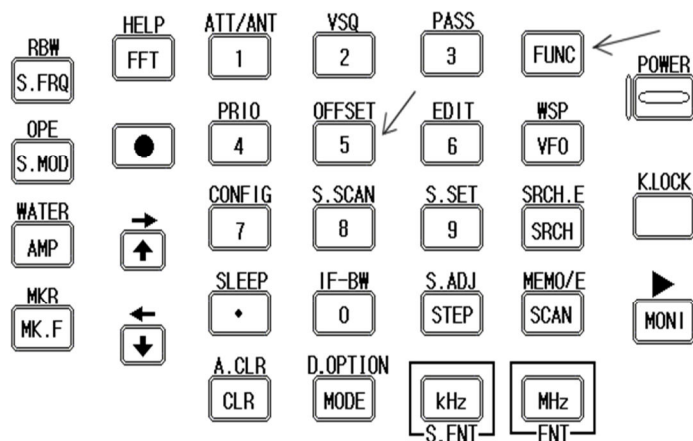

The Offset frequency set up screen will appear. Rotate the **sub dial** to select the desired pre-programmed offset frequency.

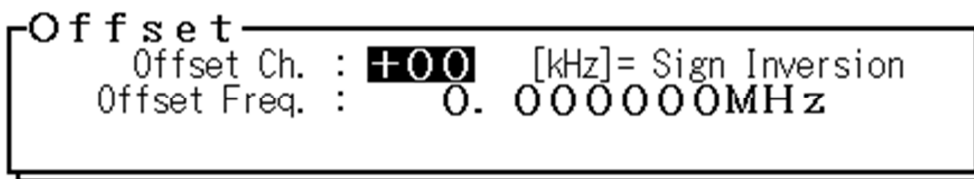

To accept the offset setting, press the  key.

Below is a list of the pre-programmed offset frequencies.



Channel number	Offset frequency
20	100 kHz
21	4.0 MHz
22	4.6 MHz
23	5.0 MHz
24	8.0 MHz
25	9.0 MHz
26	10.0 MHz
27	15.0 MHz
28	16.0 MHz
29	16.5 MHz
30	18.0 MHz
31	18.45 MHz
32	20.0 MHz
33	24.1 MHz
34	37.4 MHz
35	47.2 MHz
36	48.0 MHz
37	55.0 MHz
38	126.35 MHz
39	130.0 MHz

=====

2-9-2 Entering new frequency offset data

Assume that you are in the VFO mode.

To access the frequency offset set-up menu, perform the following steps:

1. Press the  key, then press the  key.

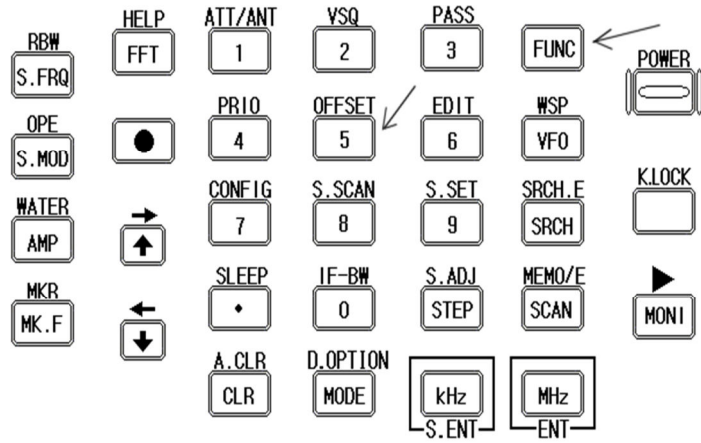

2. The Offset frequency set up screen will appear on the LCD.

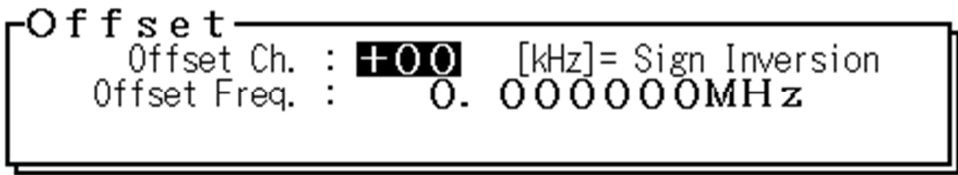

3. Rotate the **sub dial** to select the desired offset memory channel.

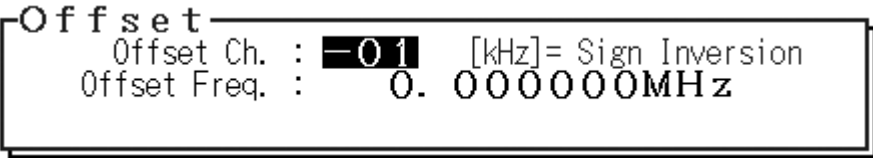

4. Using the numeric keypad, enter the desired offset frequency in MHz format.
 (The shift direction can be changed by pressing the **kHz** key.)
 (Example) For shift frequency 5 MHz, enter 5.00.

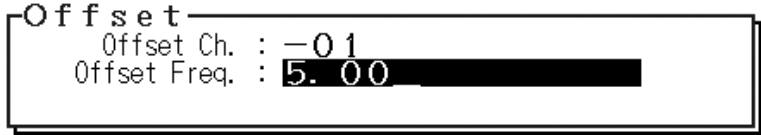

2-9-3 Activating frequency offset

To activate frequency offset, press the **MHz** key.



The **DUP** icon will display on the top of the screen to confirm operation.

2-9-4 Monitoring the offset frequency

To access the previously set offset frequency, press the **MONI** key.

2-9-5 Deactivating frequency offset

To deactivate the frequency offset function, select the +00 offset channel.

1. Press the **FUNC** key, press the **5** key.
2. The frequency offset set up screen will appear on the LCD.

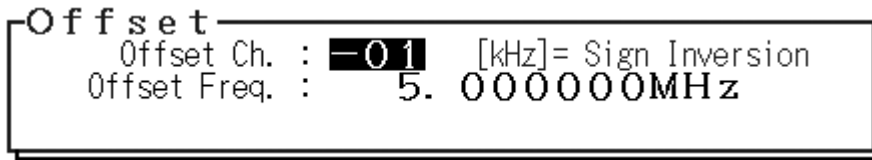

3. Rotate the sub dial to select channel +00.

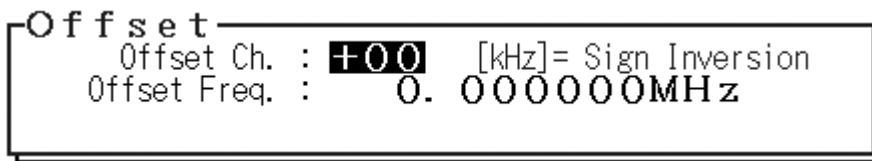

4. Press the **MHz** key to confirm entry.
5. The **DUP** icon will disappear from the screen to confirm operation.



3. Spectrum Display

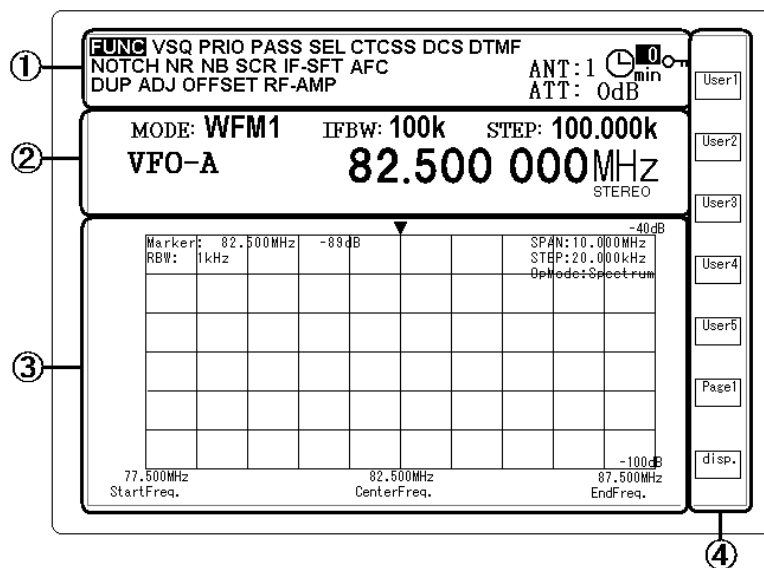

Along with a high performance professional grade receiver, the AR-ALPHA has a built-in spectrum display function that will show frequency activity over a specified bandwidth on the LCD.

3-1 LCD Display Screen (in VFO spectrum analyzer mode)



3-1-1 Operation mode display

FUNC VSQ PRIO PASS SEL CTCSS DCS DTMF
 NOTCH NR NB SCR IF-SFT AFC ANT : 1  min. 
 DUP ADJ OFFSET RF-AMP ATT : 0 dB

FUNC	Function mode	NOTCH	Auto Notch
VSQ	Voice Squelch	NR	Noise Reduction
PRIO	Priority	NB	Noise Blanker
PASS	Pass Memory	SCR	Voice De-scramble
SEL	Select Memory	IF-SFT	IF shift
CTCSS	Tone Squelch	AFC	Automatic Frequency Control
DCS	Digital Code Squelch		
DTMF	DTMF Decode		
		ANT:	Antenna Input
DUP	Duplex Mode	ATT:	Attenuator
ADJ	Frequency Adjust		
OFFSET	Frequency Offset	 min.	Timer
RF-AMP	Pre Amplifier		Key Lock

3-1-2 Basic Operation display

- VFO mode (example)

MODE : **WFM1** IFBW : **100k** STEP : **100.000k**
VFO-A **82.500 000MHz**
 STEREO

MODE	Receive mode	VFO	VFO Mode
IF-BW	IF Bandwidth	Frequency	Receiving frequency
STEP	Frequency step	Sub operation	Operation analysis STEREO mode

- Search mode (example)

MODE : **SFM** IFBW : **6k** STEP : **12.500k**
SRCH00 **381.312 500MHz**
 Cordless Tel VOICE

MODE	Receive mode	SRCH00	Search bank channel
IF-BW	IF bandwidth	Frequency	Receiving frequency
STEP	Frequency step	Sub operation	Operation analysis VOICE mode
Tag	Search bank tag	Cordless Telephone	

● **Memory Scan mode (example)**

```

MODE : WFM1  I FBW : 100k
M00-00      82.500 000MHz
           NHK FM
    
```

MODE	Receive mode	M00-00	Memory bank and memory channel
IF-BW	IF bandwidth	Frequency	Receiving frequency
Tag	Memory channel tag	NHK FM	

● **WSP (Wide Span) mode (example)**

(Note: No audio is available in WSP mode.)

```

WSP      STEP : 100.000k
      1500.000 000MHz
    
```

STEP	Frequency step
WSP	WSP mode
Frequency	Center frequency

3-1-3 Spectrum Display (example)

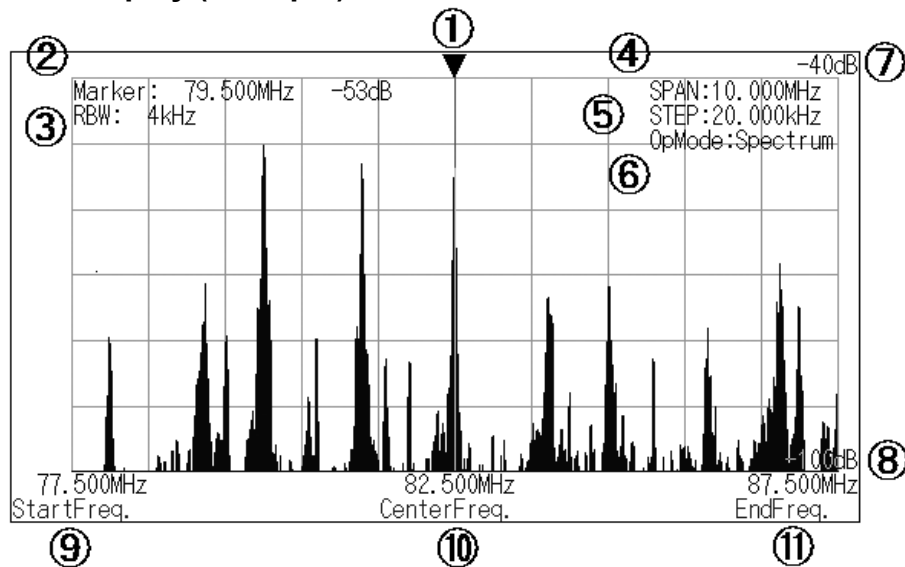

(1)	▼	Marker Position	(7)	dB (upper)	Reference level (H)
(2)	Marker:	Marker + Signal level	(8)	dB (lower)	Reference level (L)
(3)	RBW:	Resolution Band Width	(9)	StartFreq.	Start Frequency
(4)	SPAN:	Frequency Span	(10)	CenterFreq.	Center Frequency
(5)	STEP:	Frequency Step	(11)	EndFreq.	End Frequency
(6)	OpMode:	Operation Mode			

Note: The value of the Marker and the RBW will change according to the MKR operation.
The value of MAX.AVR or MED will be displayed next to RBW.

Marker MAX (example)

Marker:	84.300MHz	-100dB	
RBW:	4kHz	MAX	

Peak AVR: 5 (example)

Peak :	91.250MHz	-53dB	
RBW:	4kHz	AVR: 5	

C-Peak MED: 4 (example)

C-Peak:	91.250MHz	-69dB	
RBW:	4kHz	MED: 4	

Other display samples:

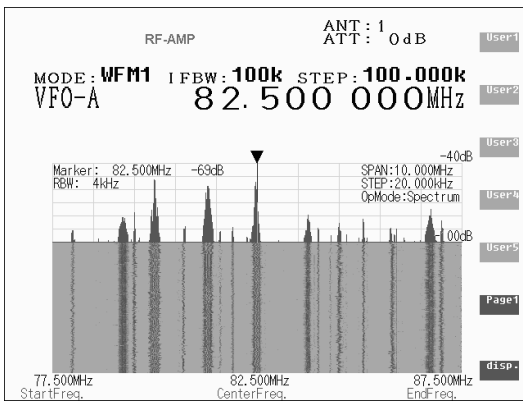

Waterfall Display

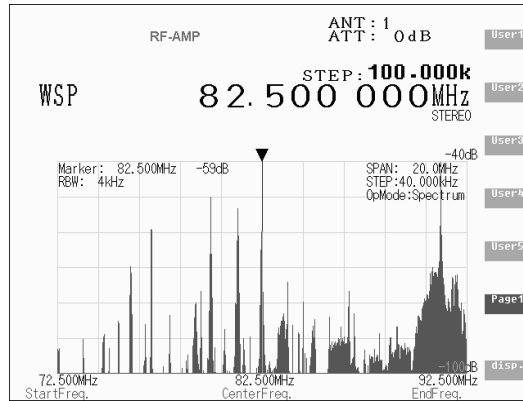

WSP Display

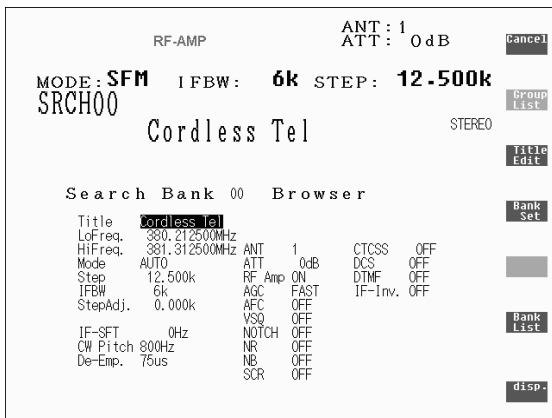

Search Band Browser

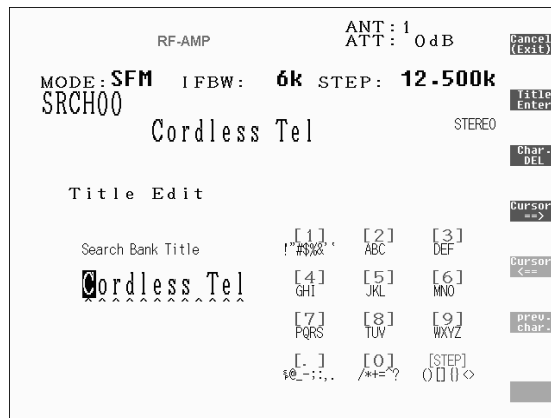

Search Tag Editor

Soft Keys

Below are the functions of the soft keys. When no description of a key is shown, there is no assigned function for the soft key in that mode.

When a soft key is displayed in a dark blue color, it is not selectable.

NORMAL	SRCH	FFT	S.FRQ	S.MOD	ATT/ANT	S.SCAN	RBW	OPE
User1	PASS List		START Freq.	S.MOD SPECT	Amp ON Att 0		RBW 1kHz	OPE MAX
User2		select Bank	END Freq.		AmpOFF Att 0		RBW 4kHz	OPE AUR
User3	UFO-D Set	select Step	CENTER Freq.	S.MOD CHANL	AmpOFF Att 10	MemCh Read	RBW 32kHz	OPE MED
User4	Newest Cursor	select Thre.	Spect. SPAN		AmpOFF Att 20	Newest Cursor	RBW 64kHz	
User5			Spect. STEP				RBW 128kHz	
Page1	List Clear	Search Start			AUTO ON	List Clear		
disp.	disp.	disp.				disp.		

3-2 Display span setting

In the normal operation mode, the maximum display span is 10 MHz (+/- 5 MHz from the center frequency.)

```
SPAN:10.000MHz
STEP:20.000kHz
OpMode:Spectrum
```

The chart at the left indicates the display span as 10 MHz and the display step is 20 kHz (per pixel).

Since there are 500 pixels on the horizontal axis, the resolution of each pixel indicates 20 kHz. (10 MHz / 500 = 20 kHz)

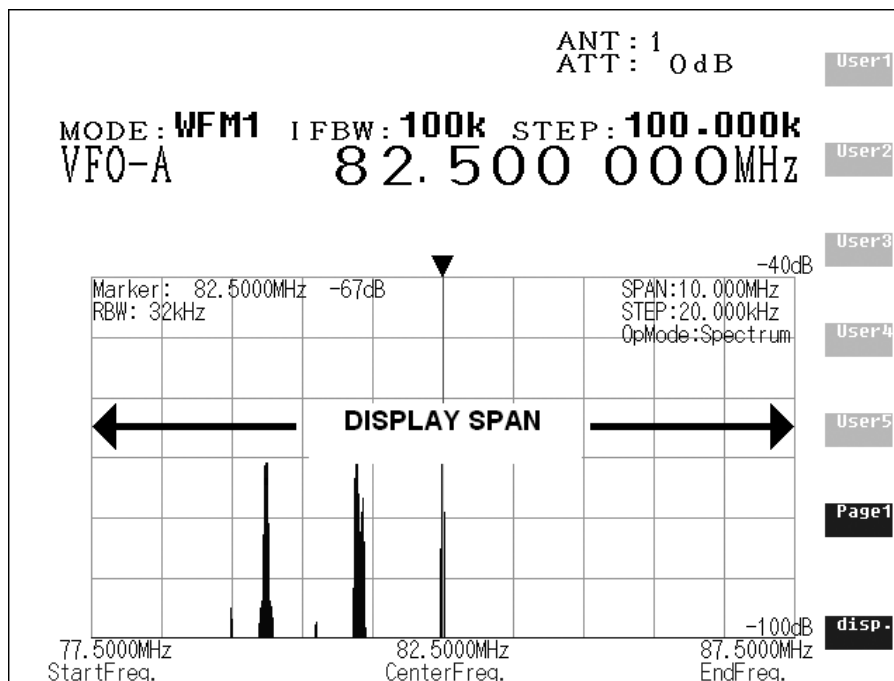

In the normal operation mode, the display span can be set between 250 kHz and 10 MHz in 1 kHz increments. In this mode, the display step is calculated automatically.

The display step can be manually set between 500 Hz and 20 kHz in 10Hz increments. In this mode, the display span is determined automatically.

In some cases, it is more convenient to set the display span by entering the start frequency and the end frequency instead of setting the center frequency.

In this case, however, you need to remember that the actual display span will change according to the start frequency or the end frequency.

3-2-1 Setting the display span

Press the **S.FRQ** key.

The description of the soft keys, and their respective functions, will be changed.

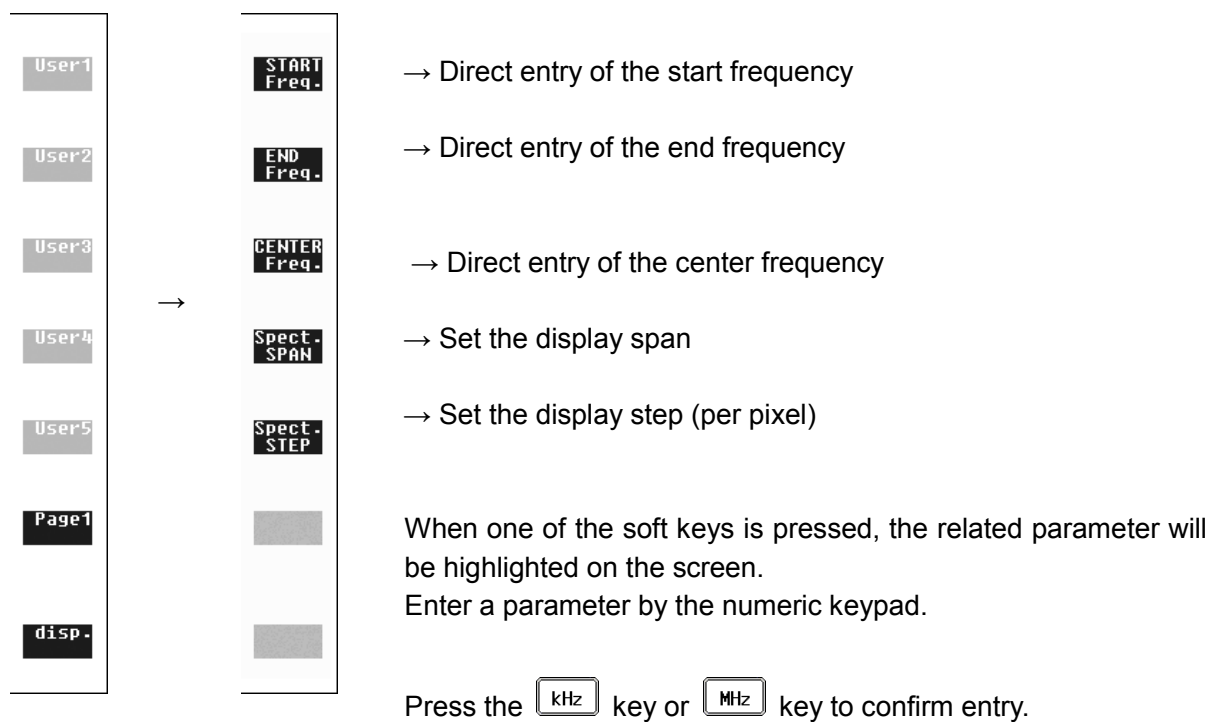

(Example) Setting the display span to 5 MHz.

Press the **S.FRQ** key, then press the **Spect-SPAN** soft key.

Press the **5** key, then press the **MHz** key to confirm entry.

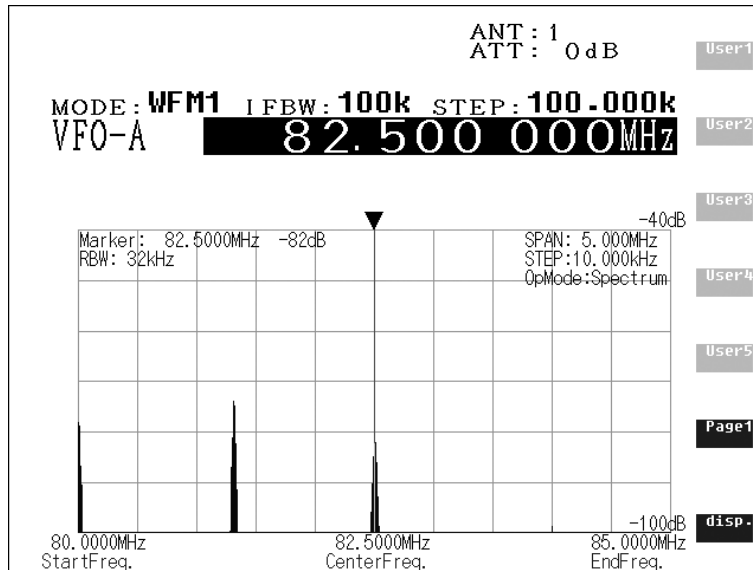

Display span is set to 5 MHz.

Setting the display span using the display frequency step (per pixel)

(Example) Set the display frequency step to 1 kHz per pixel.

Press the **S.FRQ** key, then press the **Spect. STEP** soft key.

Press the **1** key, then press the **kHz** key.

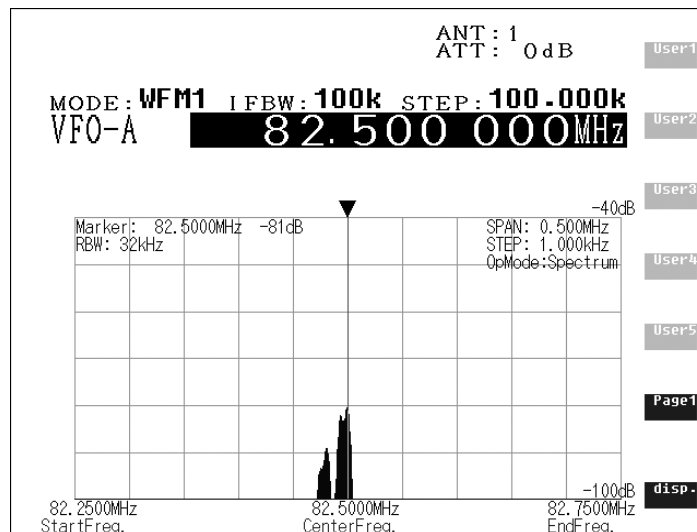

- Possible display span: 250 kHz ~ 10 MHz (in 1 kHz steps)
- Display step range (per pixel): 500 Hz ~ 20 kHz (in 10 Hz step)

4. Memory channels

Think of memory channels as pages in a notebook, each of which is numbered to identify it. Data may be written to each new page (memory channel) and each page may be overwritten with new data at any time. In other words, a memory channel can be used over and over again.

Each memory channel may hold:

- One receive frequency
- Receive mode
- Tuning step
- IF Bandwidth
- Frequency step adjust
- Voice squelch level
- Antenna input setting
- Attenuator / RF amplifier setting
- Decoding mode
- Offset frequency channel
- Frequency pass channel
- Select memory
- Text comment of up to 12 characters

4-1 Memory Bank and Memory Channel

The AR-ALPHA features 2,000 memory channels and a priority channel. There are 40 memory banks (groups) and each bank has 50 memory channels.

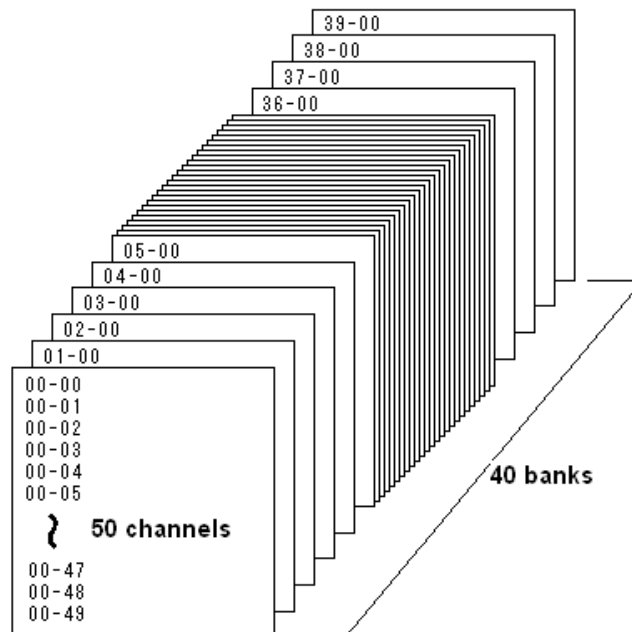

The alphanumeric comment may be used for easy identification of a specific memory channel at a future time and to provide a “text search” function. The 2,000 memory channels are divided into 40 banks, each

having 50 channels. The memory banks are identified by the first **BANK** number 0, 1, 2, 3, 4, 5, 6, 7, 8 and 9 and the individual channels are numbered from 00 to 39.

Examples are “00” for the first channel location in memory bank “0” and “39” for the last memory channel in memory bank “0”.

“04-15” is the location: memory bank “04” channel “15”.

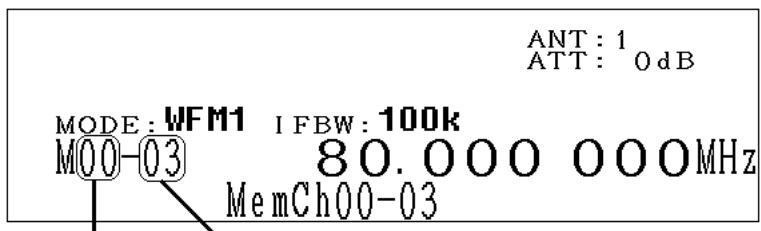

Memory bank Memory channel

The data contents of memory and search banks are held in an EEPROM; therefore no backup battery is required for memory retention.

The stored data may be quickly and easily recalled, changed or deleted using the memory recall and delete functions.

Memory channel browser (contents of memory channel)

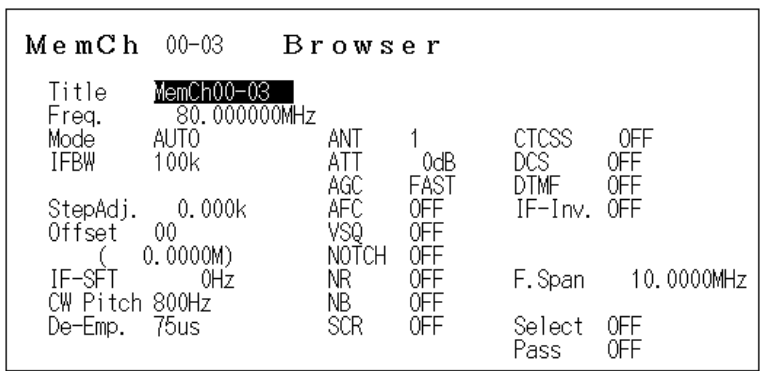

Note: When the receiver is switched OFF, all VFO data will be automatically saved into EEPROM memory storage.

4-2 Storing VFO frequencies and data into memory

The process to save a displayed VFO frequency to memory is as follows:
In the VFO mode, set the desired frequency, mode, attenuator, and so on.

(Example) Storing 80.000 MHz.

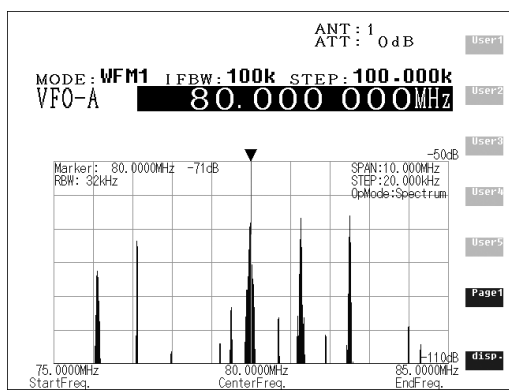

Press the **[8]**, **[0]**, **[.]**, **[0]**, **[MHz]** key from the numeric keypad.

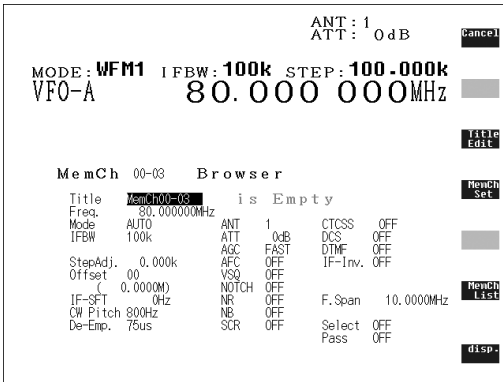

Press and hold the **SCAN** key for 2 seconds.

The VFO browser screen will appear on the LCD.

Press the **UP** key to move the cursor to highlight the **MemCh** (Memory channel) in reverse color, then enter the desired memory bank and memory channel using the numeric keypad

followed by the **MHz** key.

(Example) Enter "0415" "MHz" will select memory bank 04 and memory channel 15.

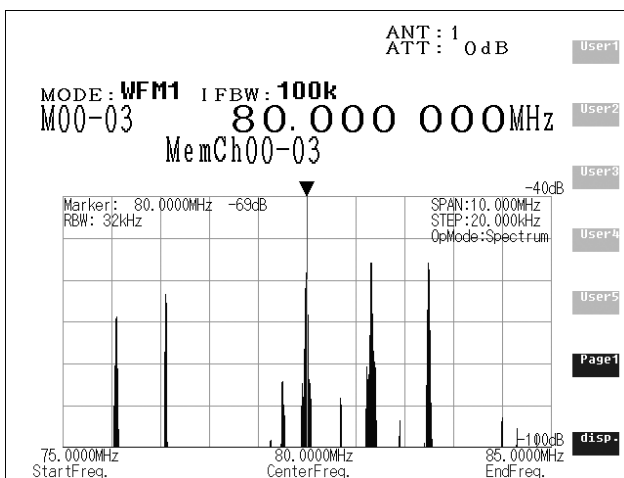

Press the **Down** key to move the cursor to highlight the **Title** in reverse color. To add a text comment (optional), press the **Title Edit** key of the soft key on the right side of the LCD. Use the numeric keypad and soft keys for text entry.

Press the **MHz** key to save the data to the specified memory location.

4-3 Memory read "M.RD"

Once frequency and mode data has been stored into a memory location, its retrieval is quick and simple.

From the VFO mode, press the **SCAN** key. This changes the VFO mode screen into the memory mode screen.

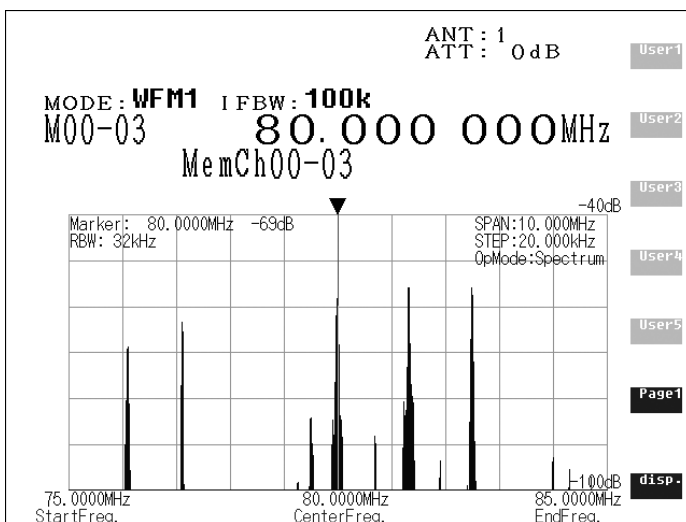

Rotate the main dial to select the desired memory channel.

If the memory bank and memory channel are already programmed, then enter the 2 digits of the memory bank number followed by the 2 digits of the desired memory channel from the numeric keypad.

(Example) Read the memory bank 00, memory channel 02.

Enter , , , , from the numeric key pad.

(Note) If a vacant memory content is recalled, then the memory bank 00, memory channel 00 will be recalled.

To return to VFO mode screen, press the key.

● **Soft key operation in memory receive mode**

Functions of User 1 ~ User 5 and Page 1 are similar to the VFO mode except the Soft Key.

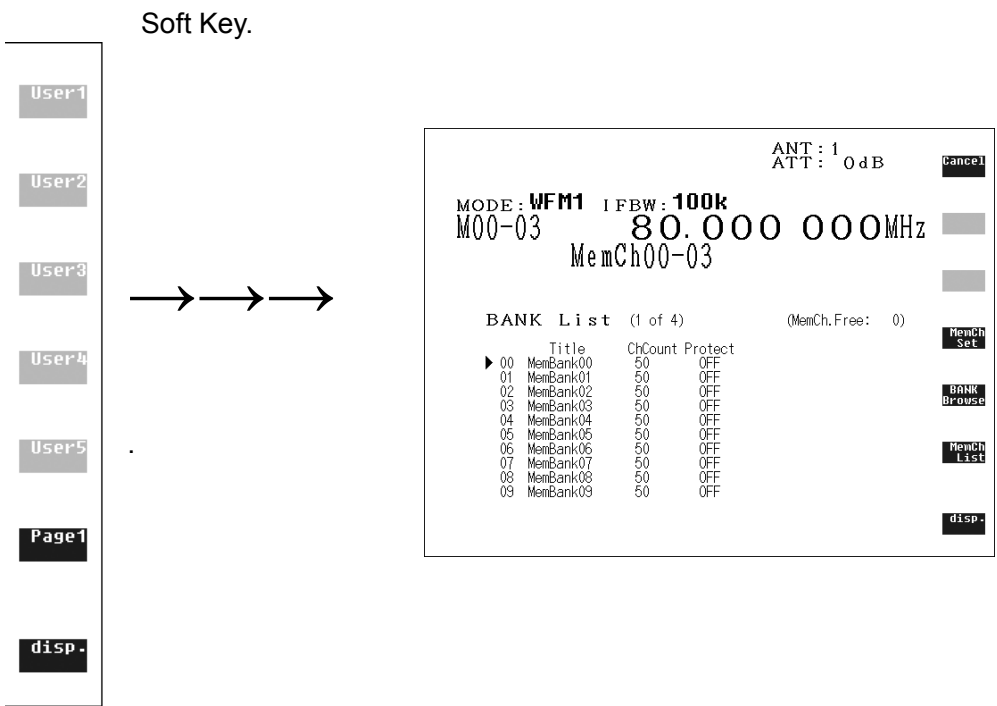

In the VFO mode, pressing the soft key will display the VFO list.
 In the memory mode, it displays the BANK List.

4-4 Memory Mode

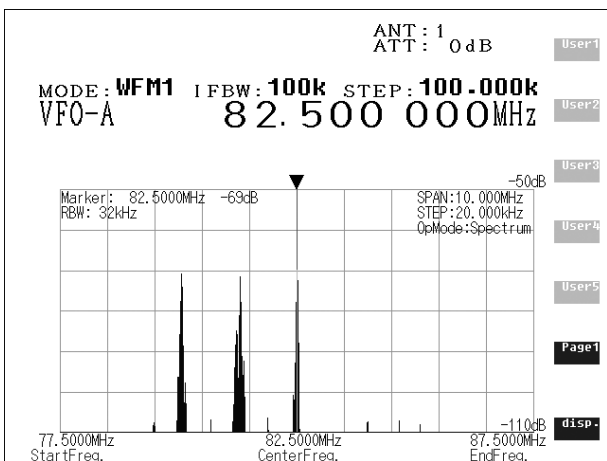

From **VFO mode** as on the left, to enter the Memory Mode, press the key.

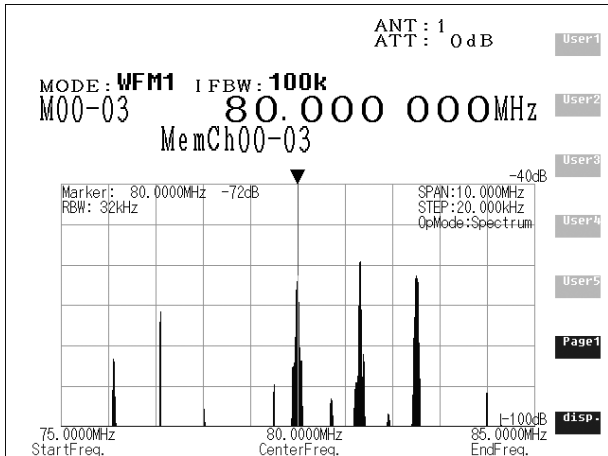

Memory mode

The “VFO-A” icon changes to “M00-03” indicating the AR-ALPHA is in the Memory Mode.

While in the Memory Mode, press the **disp.** soft key to display the Bank List.

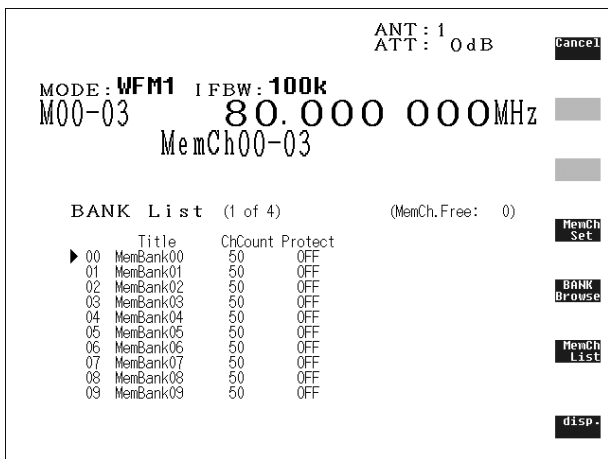

Bank List

Press the **↑** or **↓** key to browse through the bank list.

- Cancel** Return to memory screen
- MemCh Set** Memory channel set
- BANK Browse** Go to Bank browser
- MemCh List** Display channel list
- disp.** Return to memory screen

4-4-1 From *Bank List* screen to *MemBank* screen or *Browser*

Press the **BANK Browse** soft key to display the MemBank 00 Browser screen.

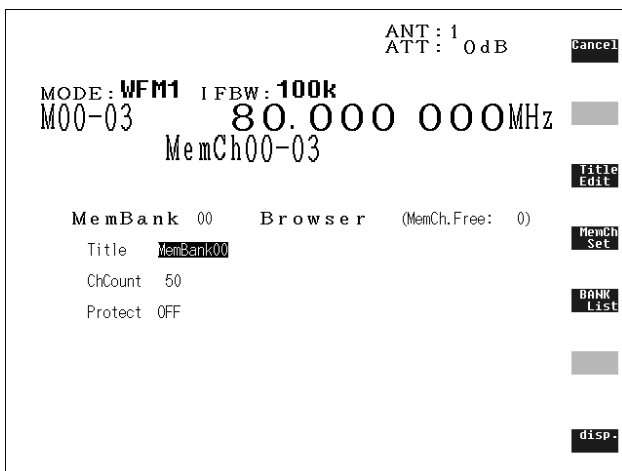

Memory Bank Browser

To move the cursor, press the **↑** or **↓** key.

- Cancel** Return to previous screen.
- Title Edit** Go to the Title Editor screen.
- MemCh Set** Return to Memory mode screen.
- disp.** Return to previous screen.

Bank number
Available free memory number

MemBank 00
Browser (MemCh.Free: 0)

Memory name tag — Title MemBank00
 Assigned memory channel number — ChCount 50
 Write protect — Protect OFF

While above screen is displayed, press the **Title Edit** key of the soft key to go into the Title Editor screen.

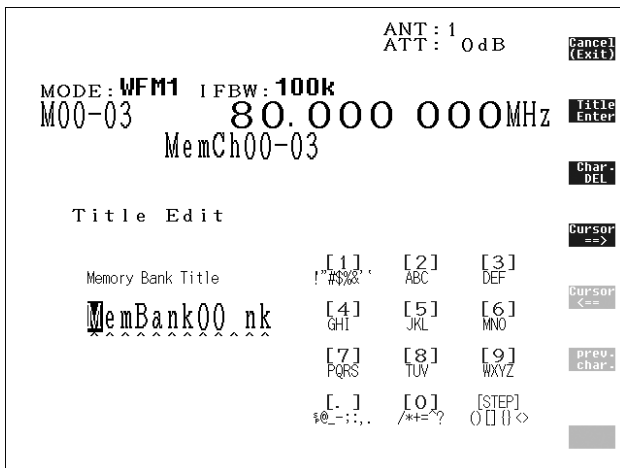

- Cancel (Exit)** Return to previous screen.
- Title Enter** Confirm title entry.
- Char-DEL** Delete character.
- Cursor =>** Move the cursor rightward.
- Cursor <=** Move the cursor leftward.
- prev-char** Select the previous character.

Memory Title (Tag) Editor

4-4-2 From BANK List to MemCh List

While the BANK List is displayed, press the **MemCh List** key of the soft key to display the channel list of the selected memory bank.

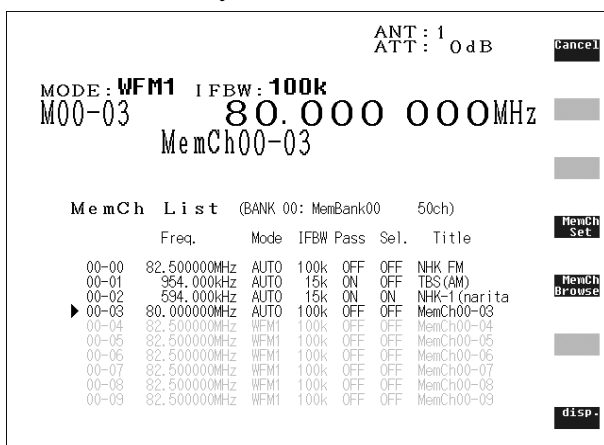

Memory Channel List

A total of 10 channel (00 ~ 09) contents will be displayed. A channel in white color indicates a registered channel, and a channel in blue color indicates the channel is not registered.

Press the or key to move the cursor.

- Cancel** Return to the previous screen.
- MemCh Set** Go to the Memory Mode screen.
- MemCh Browse** Go to the Mem. Channel Browser
- disp-** Return to the previous screen.

Channel number	MemCh	List	Bank number	Bank title	Assigned channel number			
			(BANK 00: MemBank00		50ch)			
		Freq.	Mode	IFBW	Pass	Sel.	Title	
Bank number	00-00	82.500000MHz	AUTO	100k	OFF	OFF	NHK FM	
	00-01	954.000kHz	AUTO	15k	ON	OFF	TBS(AM)	
	00-02	594.000kHz	AUTO	15k	ON	ON	NHK-1(narita)	
Cursor	00-03	80.000000MHz	AUTO	100k	OFF	OFF	MemCh00-03	
	00-04	82.500000MHz	WFM1	100k	OFF	OFF	MemCh00-04	
	00-05	82.500000MHz	WFM1	100k	OFF	OFF	MemCh00-05	
Unregistered channels	00-06	82.500000MHz	WFM1	100k	OFF	OFF	MemCh00-06	
	00-07	82.500000MHz	WFM1	100k	OFF	OFF	MemCh00-07	
	00-08	82.500000MHz	WFM1	100k	OFF	OFF	MemCh00-08	
	00-09	82.500000MHz	WFM1	100k	OFF	OFF	MemCh00-09	
		Frequency	Mode	IFBW	Pass	Select	Title	

- Bank number: Current bank number
- Bank title: Named title for the bank
- Frequency: Stored receive frequency
- Mode: Stored receive mode
- IFBW: Stored IF bandwidth
- Pass Setting: Stored pass setting
- Select: Stored select setting
- Channel title: Stored memory tag
- Assigned channel number: The channel number in the assigned bank

4-4-3 From MemCh List to MemCh **-** Browser

Press the **MemCh Browse** key to display the Memory Channel Browser of the selected memory channel.

ANT: 1
ATT: 0dB

MODE: WFM1 IFBW: 100k
M00-03 80.000 000MHz
MemCh00-03

MemCh 00-03 Browser

Title	MemCh00-03	Cancel
Freq.	80.000000MHz	Title Edit
Mode	AUTO	MemCh Set
IFBW	100k	MemCh List
StepAdj.	0.000k	disp
Offset	0 (0.0000M)	
IF-SFT	0Hz	
CW Pitch	800Hz	
De-Emph.	75us	
ANT	1	
ATT	0dB	
AGC	FAST	
AFC	OFF	
VSG	OFF	
NOTCH	OFF	
NB	OFF	
SCR	OFF	
CTCSS	OFF	
DCS	OFF	
DTMF	OFF	
IF-Inv.	OFF	
F. Span	10.0000MHz	
Select	OFF	
Pass	OFF	

- Cancel** Return to previous screen.
- Title Edit** Go to Title Editor screen.
- MemCh Set** Go to Memory Mode screen.
- MemCh List** Return to MemCh List screen.
- disp** Return to previous screen.

Memory Channel Browser

MemCh 00-03 Browser

```

Title MemCh00-03
Freq. 80.000000MHz
Mode AUTO ANT 1 CTCSS OFF
IFBW 100k ATT 0dB DCS OFF
AGC FAST DTMF OFF
StepAdj. 0.000k AFC OFF IF-Inv. OFF
Offset 00 VSQ OFF
( 0.0000M) NOTCH OFF
IF-SFT 0Hz NR OFF F.Span 10.0000MHz
CW Pitch 800Hz NB OFF
De-Emp. 75us SCR OFF
Select OFF
Pass OFF
    
```

Title	Channel Tag				
Freq.	Receive frequency				
Mode	Receive mode	ANT	Antenna select	CTCSS	CTCSS setting
IFBW	IF bandwidth	ATT	Attenuator	DCS	DCS setting
		AGC	AGC setting	DTMF	DTMF setting
StepAdj.	Step adjust	AFC	AFC setting	IF-Inv.	IF inversion
Offset	Offset	VSQ	Voice squelch setting		
		NOTCH	Notch filter		
IF-SFT	IF shift	NR	Noise reduction	F.Span	Frequency span
CW Pitch	CW pitch frequency	NB	Noise blanker		
De-Emp.	De-emphasis	SCR	Voice Descrambler	Select	Select setting
				Pass	Pass setting

Title (Tag) Editor

While the Memory Channel Browser screen is displayed, press the **Title Edit** key to go to Title Editor screen.

- Cancel (Exit)** Return to the previous screen.
- Title Enter** Confirm entry
- Char-DEL** Delete character
- Cursor =>** Move cursor rightward
- Cursor <==** Move cursor leftward
- prev-char** Select the previous character

- Soft key operation and functions

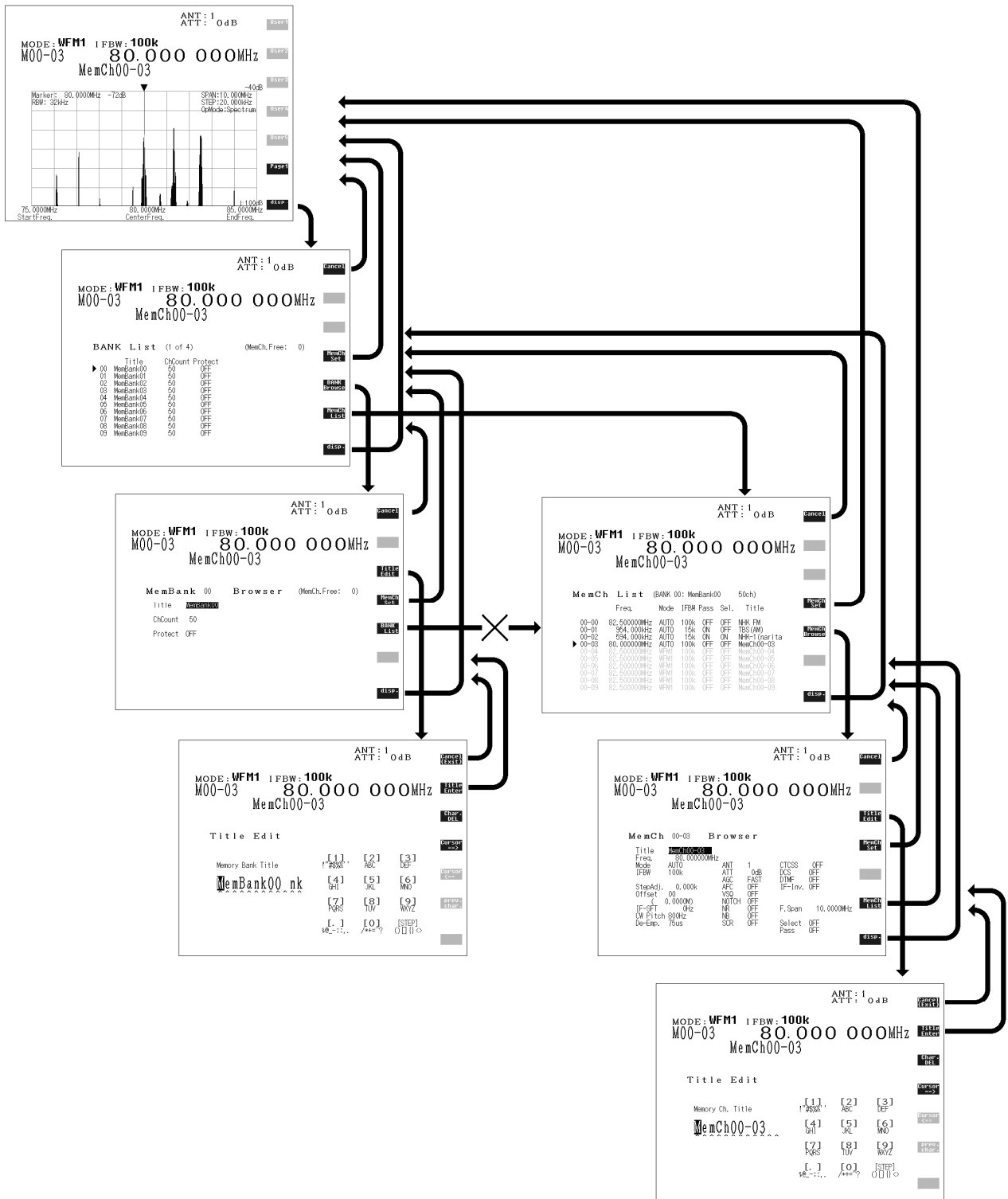

5. SCAN – scanning memory channels

The AR-ALPHA has a **SCAN** mode whereby the contents stored in the **MEMORY CHANNELS ARE AUTOMATICALLY RECALLED AND MONITORED** very quickly, that is, “scanned” for activity.

*** It is important that you do not confuse **SCAN** and **SEARCH** modes. ***

SEARCH mode (covered later in this manual) automatically **TUNES THE RECEIVER THROUGH ALL FREQUENCIES** between two specified frequency limits, looking for active frequencies.

5-1 SCAN – outline introduction

During SCAN, the AR-ALPHA automatically recalls memory channels which contain data (in numeric order) and monitors them looking for activity. When an ‘active’ memory channel is located (when a signal is found and the squelch is open), the AR-ALPHA will temporarily stop scanning.

5-2 Starting SCAN

Before starting the scan process, some memory channels need to be pre-programmed with data.

Ensure that the squelch is set to the threshold point so that background noise is cancelled and the squelch closes (otherwise the scan function will not operate).

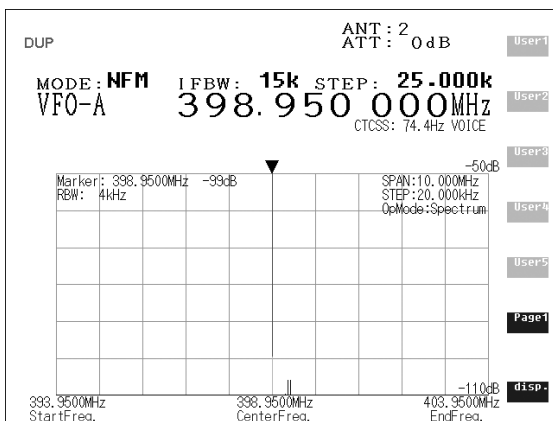

VFO mode screen (example)

In the VFO mode (as shown to the left), press the **SCAN** key to go into the memory mode.

Rotate the main dial to select the desired memory bank to scan.

Press the **SCAN** key again.

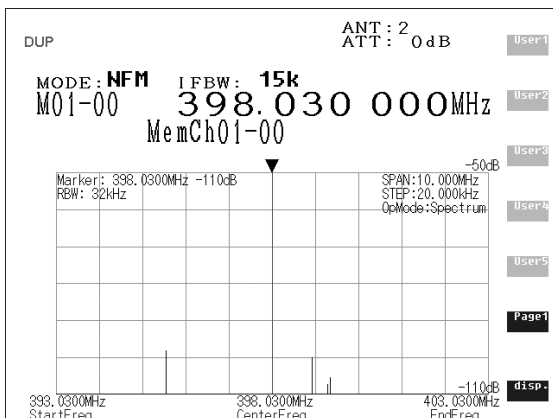

Memory mode screen (example)

When SCAN has been selected, only the currently displayed memory bank WHICH CONTAINS DATA will be scanned, receive mode and frequency are unimportant. Any memory channels that contain no data (empty) will be ignored (skipped).

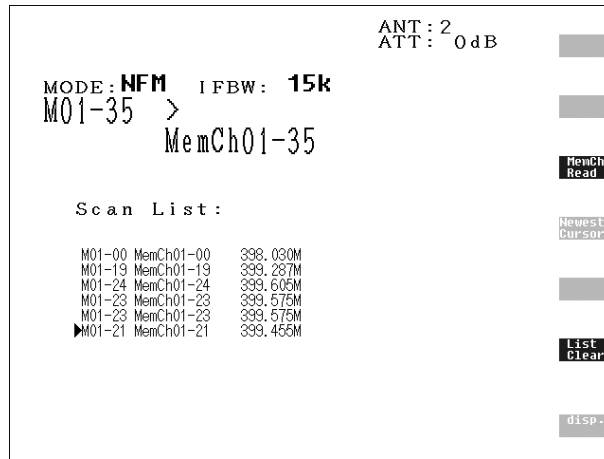

Scan mode (searching)

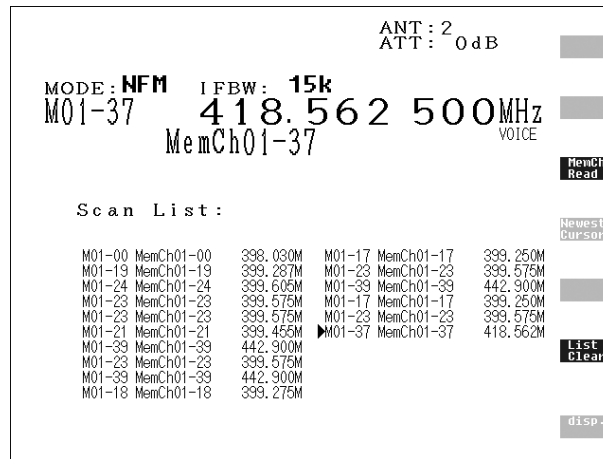

Scan mode (receiving)

5-3 Scan operation

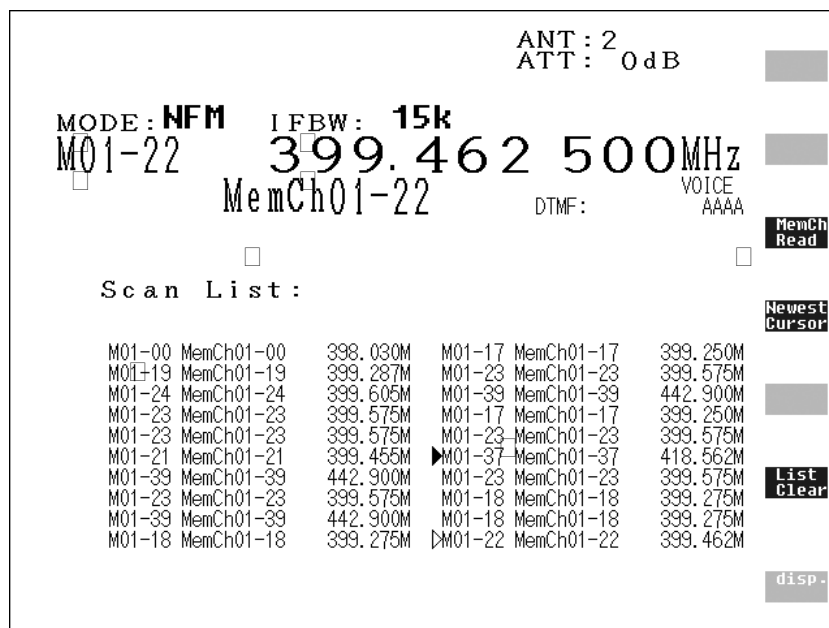

	Item	Operation
<input type="checkbox"/>	MODE:NFM	Receive mode
<input type="checkbox"/>	IFBW:15k	Receiver IF bandwidth
<input type="checkbox"/>	M01-22	Bank 01, Channel 22
<input type="checkbox"/>	399.462500 MHz	Memory channel frequency
<input type="checkbox"/>	MemCh01-22	Memory channel text
<input type="checkbox"/>	VOICE	Decoding mode: VOICE
<input type="checkbox"/>	DTMF: AAAA	DTMF decoded data
<input type="checkbox"/>	M01-00Mem Ch01-00 398.030M	Scan List
<input type="checkbox"/>	▶	Cursor
<input type="checkbox"/>	▷	Current receive channel

- Display during memory scan

While scanning, the blinking > appears instead of memory channel frequency.

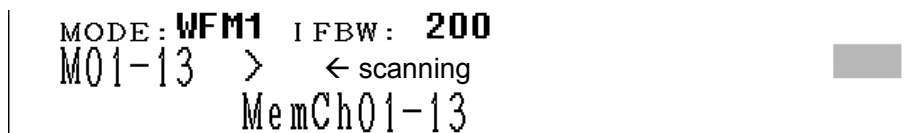

If more than one memory channel is programmed into the current memory bank, when an 'active' channel has been located (busy, so the squelch opens), the scan process will temporarily pause on the active channel, and the memory location will be displayed along with any accompanying text.

- Soft key operations

MemCh Read Read the memory channel at the cursor.

Newest Cursor Move the cursor to the recently scanned channel.

List Clear Clear (delete) the scan list.

5-3-1 Changing scan direction

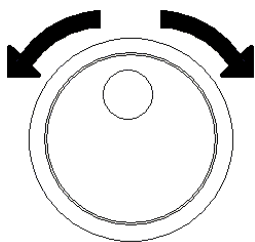

Scanning direction can be changed by rotating the main dial.

5-4 Selecting a scan bank

To select another memory bank for scanning, use the numeric keypad to enter 4 digits.

(Example: Select bank 02)

If no data is available, the next bank with valid data will be recalled (empty memory banks are skipped). To exit from the **SCAN** mode, press the **VFO** key.

5-5 Bank Link

The AR-ALPHA has a built-in Bank Link function to allow scanning a single bank or a user-selected group of memory banks.

5-5-1 Setting Bank Link

1. Press the **FUNC** key, then press and hold the **SCAN** key for 2 seconds.
2. The Scan Group screen will appear.

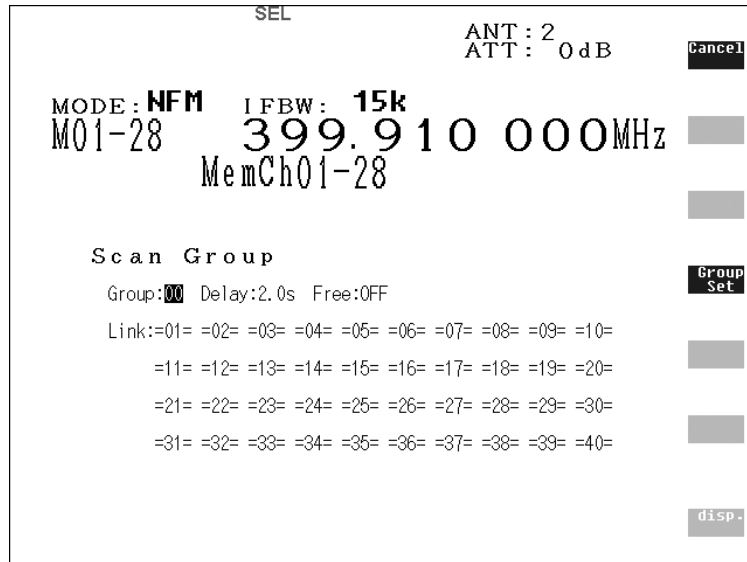

Group: 00	Scan group number	00, 01 ~ 19
Delay: 2.0s	Scan delay time	0.1 ~ 9.9s (in 0.1 second steps)
Free: OFF	Scan free time	OFF (00), 01 ~ 60 seconds

3. Rotate the sub dial to select the desired item, then use the **↑** or **↓** key to change.
4. Validate with “Group Set” soft key or the MHz key.

Press the **Cancel** key if you prefer to cancel.

5-6 Select Scan

Select scan enables you to ‘tag’ memory channels to make a temporary list up to 50 channels in the same memory bank for scanning in a separate list called the SELECT SCAN LIST.

5-6-1 Adding select scan channels in memory read

1. Press the **SCAN** key to enter the memory mode.
2. Locate the memory channel to add select scan channel.
3. Press the **FUNC** key, then press the **9** key.
4. The ‘SEL’ icon will appear on the LCD.

```

SEL
ANT : 1
ATT : 0dB

MODE : WFM1  I FBW : 100k
M00-00      82.500 000MHz
           NHK FM

```

(Example)

Adding select scan channels can also be performed in the memory channel browser screen.

```

MemCh 00-00  Browser

Title      NHK FM
Freq.     82.500000MHz
Mode      AUTO      ANT      1      CTCSS   OFF
IFBW     100k      ATT      0dB    DCS     OFF
AGC      FAST     DTMF    OFF
StepAdj. 0.000k    AFC     OFF    IF-Inv. OFF
Offset   00      VSQ    OFF
      ( 0.0000M)  NOTCH  OFF
IF-SFT   0Hz     NR     OFF    F. Span 10.0000MHz
CW Pitch 800Hz   NB     OFF
De-Emp.  75us   SCR    OFF    Select ON
Pass     OFF

```

Memory channel browser

5-6-2 Start select scan

Press the **FUNC** key, then press the **8** key.

```

SEL
ANT : 1
ATT : 0dB

MODE : NFM  I FBW : 15k
M00-00      82.500 000MHz
           NHK FM

Select Scan List :

M00-00 NHK FM      82.500M  M01-05 MemCh01-05  398.460M
M00-02 NHK-1(narita 594k  M00-00 NHK FM      82.500M
▶M00-00 NHK FM      82.500M  M00-02 NHK-1(narita 594k
M01-04 MemCh01-04  398.310M  M01-01 MemCh01-01  398.050M
M01-05 MemCh01-05  398.460M  M01-02 MemCh01-02  398.110M
M01-07 MemCh01-07  398.640M  M01-04 MemCh01-04  398.310M
M01-09 MemCh01-09  398.650M  M00-00 NHK FM      82.500M
M00-02 NHK-1(narita 594k  M00-02 NHK-1(narita 594k
M01-01 MemCh01-01  398.050M  M01-01 MemCh01-01  398.050M
M01-04 MemCh01-04  398.310M  M01-02 MemCh01-02  398.110M

List Clear

disp.

```

MemCh Read Add the channel to the select memory.

Newest Cursor Transfer the cursor data to the newest list.

List Clear Clear the displayed list.

5-7 Channel Pass

When scanning, you may encounter active memory channels which you do not wish to currently monitor. It is possible to manually force the scan process to continue.

5-7-1 Setting channel pass

1. Press the **SCAN** key to enter the memory mode.
2. Select the memory channel you wish to pass.
3. Press the **FUNC** key, then press the **3** key.
4. The 'PASS' icon will appear on the LCD.

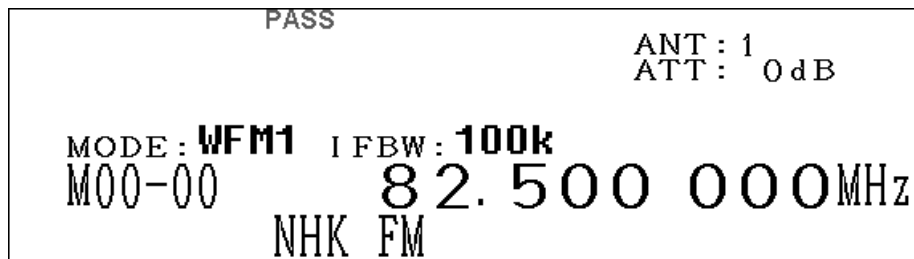

You can also do the same on the memory channel browser screen.

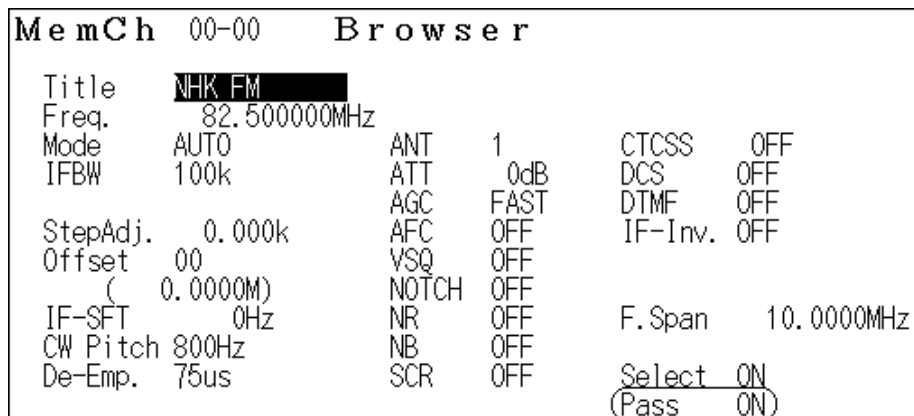

6. Search

6-1 Search Setting

6-1-1 Setting

1. Press and hold the **SRCH** key for 2 seconds.
2. The following screen will appear.

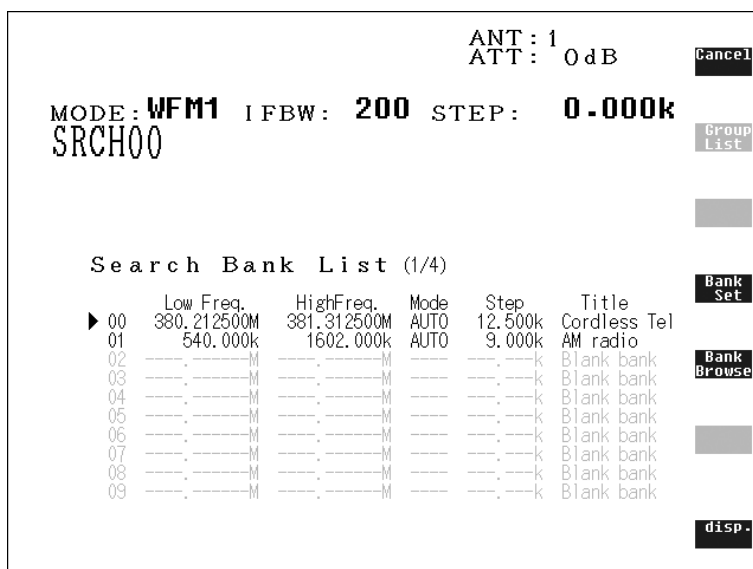

3. Press the **Bank Browse** key.
4. The following screen will appear.

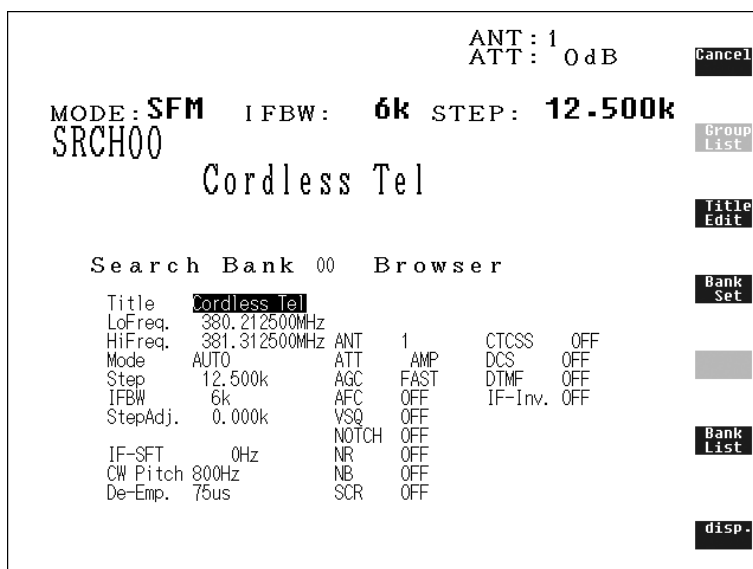

6-1-2 Search Bank Browser setting

Search Bank 00 Browser					
Title	Cordless Tel				
LoFreq.	380.212500MHz				
HiFreq.	381.312500MHz	ANT	1	CTCSS	OFF
Mode	AUTO	ATT	AMP	DCS	OFF
Step	12.500k	AGC	FAST	DTMF	OFF
IFBW	6k	AFC	OFF	IF-Inv.	OFF
StepAdj.	0.000k	VSQ	OFF		
		NOTCH	OFF		
IF-SFT	0Hz	NR	OFF		
CW Pitch	800Hz	NB	OFF		
De-Emp.	75us	SCR	OFF		

Title	Name Tag				
LoFreq.	Lower limit freq.				
HiFreq.	Upper limit freq.	ANT	Antenna	CTCSS	CTCSS setting
Mode	Receive mode	ATT	Attenuator	DCS	DCS setting
Step	Frequency step	AGC	AGC setting	DTMF	DTMF setting
IFBW	IF bandwidth	AFC	AFC setting	IF-Inv.	IF inversion
StepAdj.	Step adjust	VSQ	Voice squelch		
		NOTCH	Notch filter		
IF-SFT	IFshift	NR	Noise reduction		
CW Pitch	CW pitch frequency	NB	Noise blanker		
De-Emp.	De-emphasis	SCR	Voice Descrambler		

To browse through the settings to be edited, press the up or down arrows.

The title can be edited by pushing the “Edit Title” soft key.

You can change the lower and upper limit frequencies by selecting these and simply enter a new frequency with the ten keys.

The remaining values can be changed using the sub-dial.

Validate the changes with the “Bank Set” soft key.

6-1-3 Start search



1. Press the  key.
2. The following screen will appear.

RF-AMP	ANT: 1	PASS
	ATT: 0dB	List
MODE: AUTO	IFBW: 6k	STEP: 12.500k
SRCH00	380.575000MHz	
	Cordless Tel	
Search :		
380.212500M	380.350000M	380.475000M
380.225000M	380.362500M	380.487500M
380.250000M	380.375000M	380.500000M
380.262500M	380.387500M	380.512500M
380.275000M	380.400000M	380.525000M
380.287500M	380.412500M	380.537500M
380.300000M	380.425000M	380.550000M
380.312500M	380.437500M	380.562500M
380.325000M	380.450000M	▶ 380.575000M
380.337500M	380.462500M	
		disp.

To change the Search Bank, enter a 2-digit number (00~39) from the numeric keypad.

- PASS List** Go to PASS Freq. List.
- VFO-D Set** The frequency selected by the cursor will be sent to the VFO (using VFO-D).
- Newest Cursor** Move to the newest receive frequency.
- List Clear** Delete all search list.

● **Transfer to VFO-D**

Use the   key to select the desired frequency to transfer.



Pressing the **VFO-D Set** key will transfer the selected frequency to VFO-D.

Search :

380.987500M	381.112500M
381.000000M	381.125000M
381.012500M	381.137500M
381.025000M	▶ 381.150000M
381.037500M	381.162500M
381.050000M	381.175000M
381.062500M	381.187500M
381.075000M	381.200000M
381.087500M	381.212500M
381.100000M	▷ 381.225000M

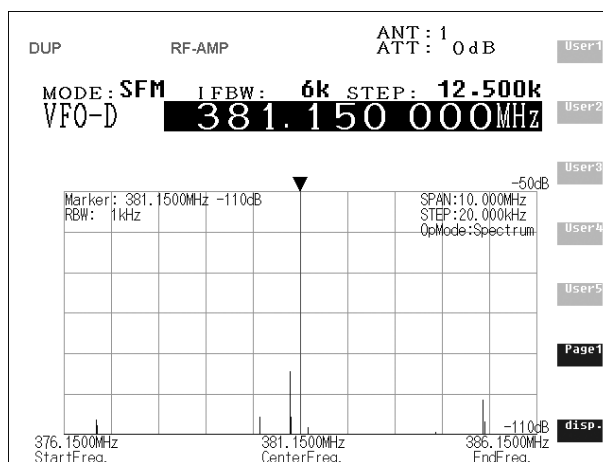
→→→



Press the   to move the cursor to select desired frequency list key, then press the **VFO-D Set** key to transfer the VFO mode.

● **Pass List**

In the Search mode, press the **PASS List** key to select the Frequency Pass List.

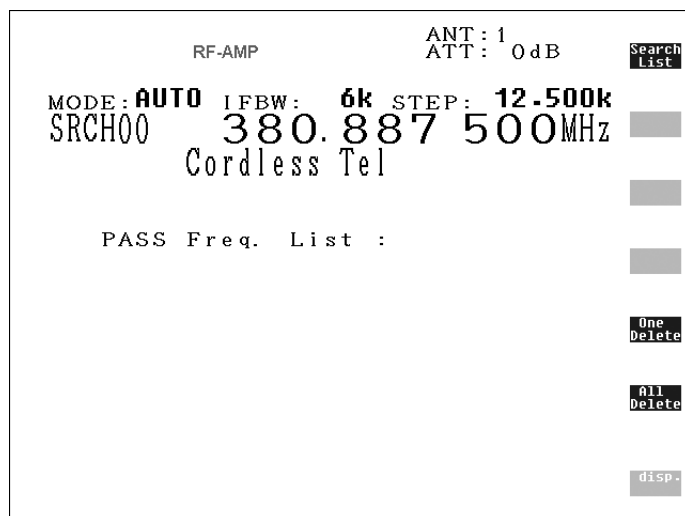

Search List Return to the Search List screen.

One Delete Delete the frequency at the cursor in the PASS Freq. List.

All Delete Delete all PASS frequencies from the frequency list.

6-2 Search Group

The search function will tune continuously between two (2) selected frequencies in increments of the currently designated frequency step. By using the Search group function, it automatically searches frequencies across the pre-selected search groups.

6-2-1 Setting Search Group

Press the **FUNC** key, then press and hold the **SRCH** key for 2 seconds.
The following screen will appear.

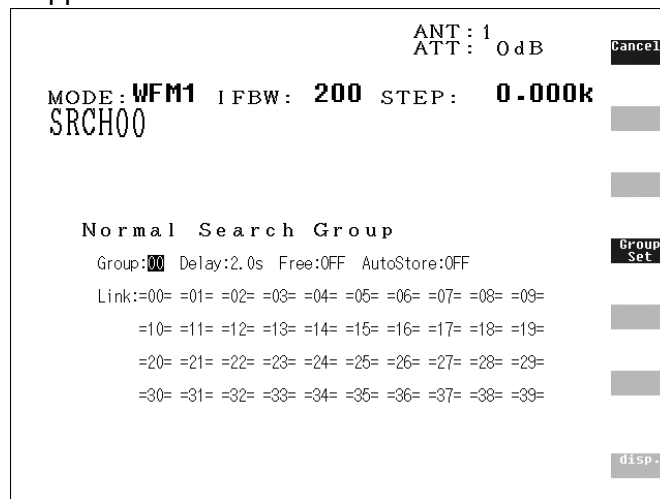

To select a category, rotate the sub dial.

- Group:00 A total of 19 (01~19) can be selected. To select the group, use the **↑** **↓** key.
(Note: The 00 cannot be selected.)
- Delay:2.0s Duration before resuming search after a signal is received.
Selectable range: 0.0~9.9 (seconds)
To set the delay, use the **↑** **↓** key.
- Free:OFF Duration of receiving.
Selectable range: OFF, 01~60 (seconds).
To set the duration, use the **↑** **↓** key.
- AutoStore:OFF Select auto store on/off.
This function will automatically store an active frequency into memory bank 39.
If memory channels on bank 39 are full, then a frequency will be overwritten.
- Link: Displays search bank of 00~39. To select the search bank, rotate the sub dial and press the **↑** key or press the **↓** key to deselect.

Press the **Group Set** soft key to start group search.

• Soft key operation and functions

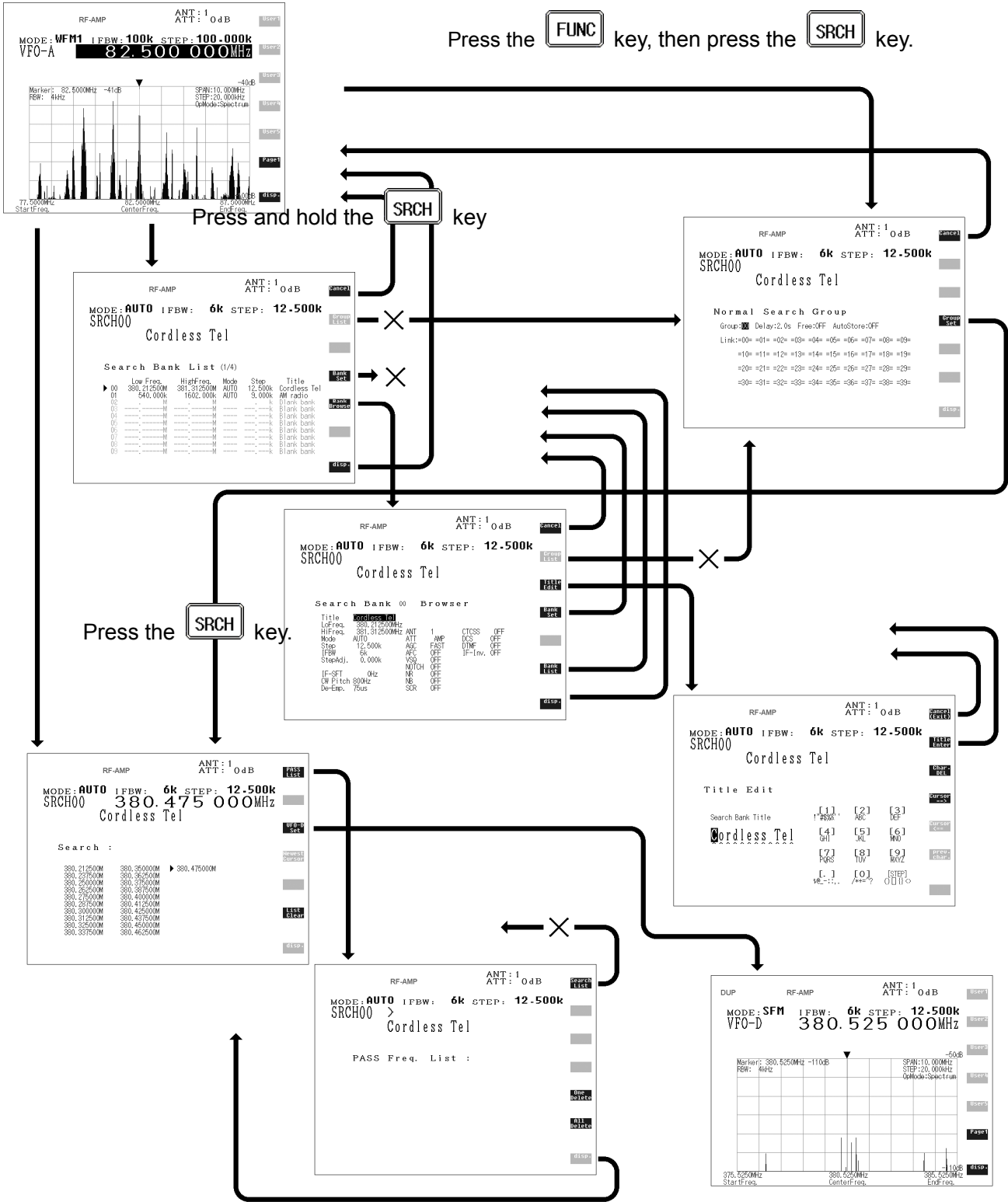

7. FFT Search

The AR-ALPHA has a FFT (Fast Fourier Transform) search function that enables high speed searches using search bank data.

Unlike the ordinary search function that searches between a low frequency and a high frequency, the AR-ALPHA FFT search examines a 10 MHz block of band data. When more than 10 MHz of bandwidth needs to be searched, the AR-ALPHA will automatically continue the FFT search process in 10 MHz increments.

7-1 FFT Search setting

1. Press the  key.
2. The following screen will appear.

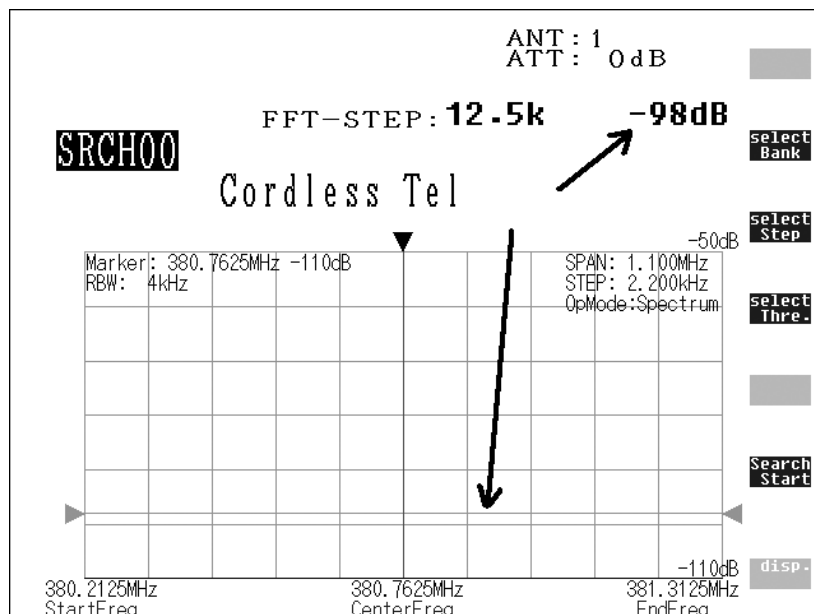

 select Bank

Recall bank setting.

 select Step

Set Search bank (selectable range: 00~39)

 select Thre.

Recall FFT frequency step. Rotate the sub dial to select.

 Search Start

Recall threshold level of FFT search. Rotate the sub dial to select.

Start FFT search.

7-1-1 FFT Search Screen

RF-AMP

SRCH00

FFT Search :

ANT : 2
ATT : 0dB

FFT-STEP : **12.5k** **-105dB**

Cordless Tel

381.05000M	380.27500M	380.45000M	380.32500M
380.21250M	380.28750M	▶ 381.05000M	380.45000M
380.27500M	380.31250M	380.31250M	381.05000M
380.28750M	380.32500M	380.32500M	380.27500M
380.31250M	380.45000M	380.45000M	380.28750M
380.32500M	381.05000M	381.05000M	380.31250M
380.45000M	380.27500M	380.27500M	380.32500M
381.05000M	380.28750M	380.28750M	380.45000M
381.06250M	380.31250M	380.30000M	381.05000M
380.21250M	380.32500M	380.31250M	380.45000M

Pause

Re Start

VFO-D Set

Newest Cursor

List Clear

return FFTset

Pause

Pause FFT search.

Re Start

Resume FFT search.

VFO-D Set

Transfer the cursor frequency to VFO-D.

Newest Cursor

Move the cursor to the latest position.

List Clear

Delete the frequency list searched by FFT.

return FFTset

Return to the FFT search screen.

- Soft key function operation and functions

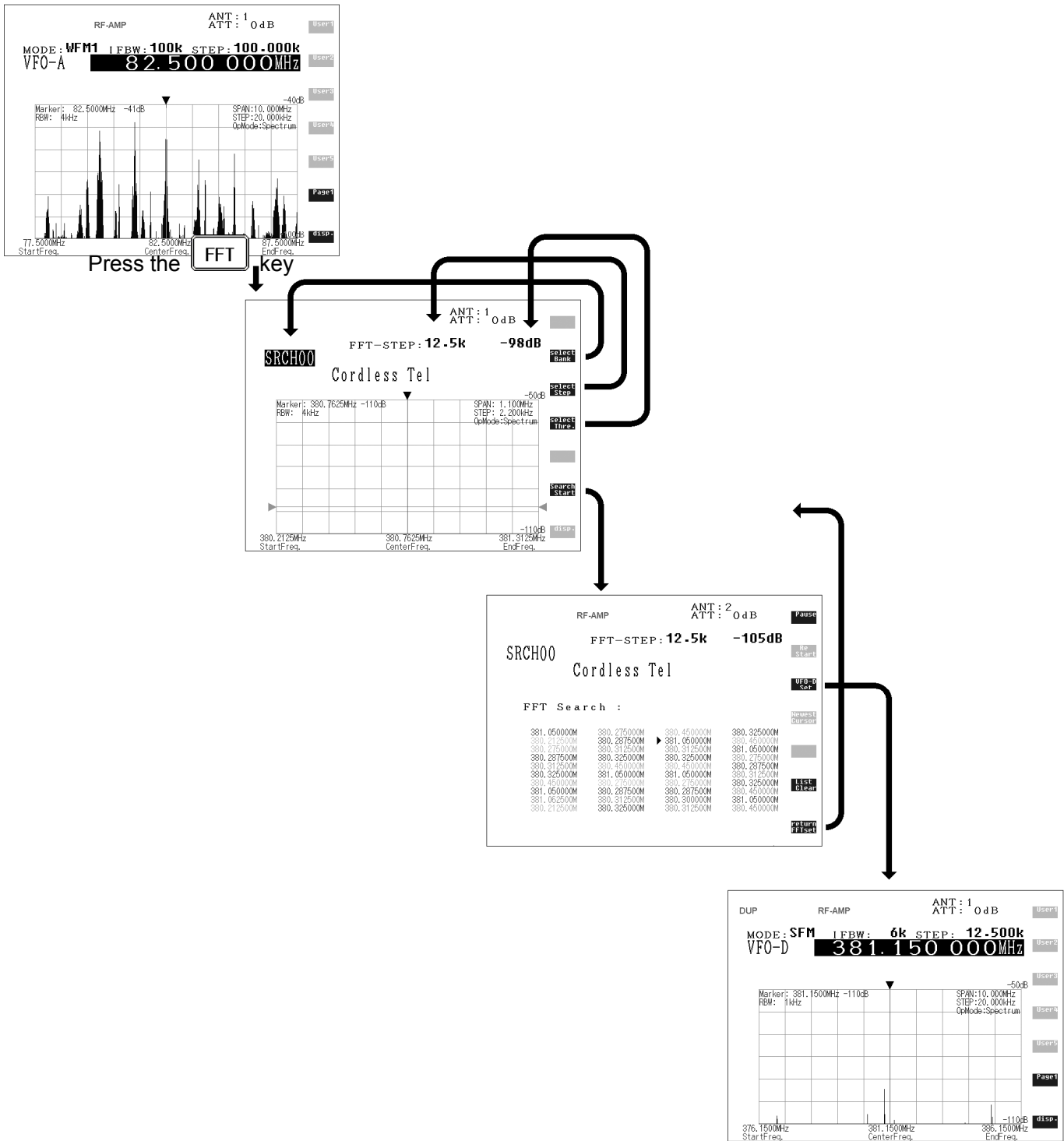

8. MISCELLANEOUS SETTINGS

8-1 Soft key registration

The functions of the soft keys vary with respect to each operation screen. By assigning variable functions to each soft key, it is much easier to operate the AR-ALPHA.

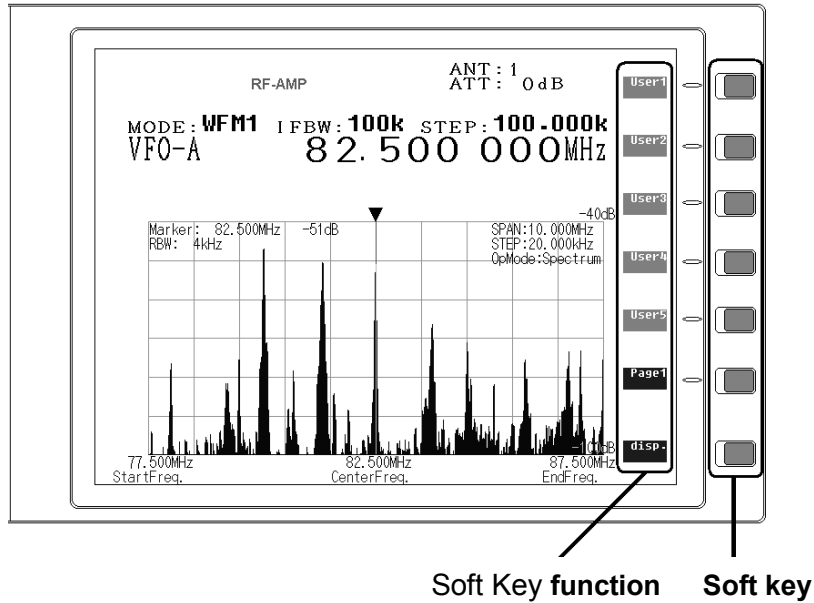

8-1-1 Soft Key Operation

User1	Yellow color	Function on the process to be assigned.
User1	Clear blue color	Function assigned
	Dark blue color	No function assigned

- **Switch between User1~User5 and User6~User10**

Press the **Page1** key or **Page2** key.

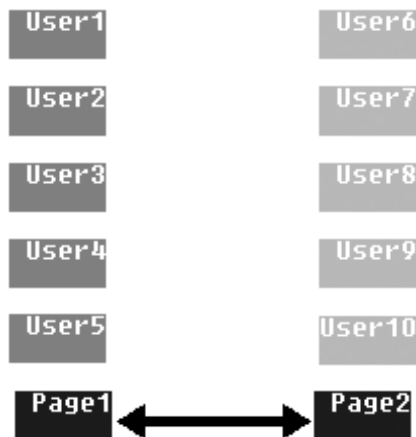

8-1-2 Soft key registration

(Example) Assign the User1 key to set a V.SCR (Voice Descrambler) frequency of 2100Hz.

1. Press and hold the User1 soft key for 2 seconds.



The color of the User1 key will change from blue to yellow and 9 appears below the soft key.

This number represents the number of remaining steps which can be registered into each “user” key.

In the meantime, the **Page1** key will change to the **Reg. Abort** key.

Press the **FUNC** key.



The **FUNC** icon will appear.

The number below the soft key is changed from 9 to 8.

2. Press the **MODE** key.



The **D.Option** setting sub-screen is displayed.

The number below the soft key is changed from 8 to 7.

3. Press the **UP** key three (3) times.



The **V.SCR** changes in reverse color.

The number below the soft key is changed from 7 to 6.

4. Rotate the sub dial to select 2100Hz.



The **SCR** icon is displayed.

The number below the soft key is changed from 6 to 5.

5. Press the **MHz** key.



The **D.Option** setting sub-screen will go off.

The number below the soft key is changed from 5 to 4.

6. Press and hold the **User1** soft key for 2 seconds.



The color of **User1** will change from yellow to blue.

This completes registration of the selected functions in the soft key.

As described above, using the assigned soft key will greatly simplify complex key operations.

8-2 Voice Recording

The AR-ALPHA has a built in DVR (Digital Voice Recorder).

Total recording time is up to 25 minutes (except in the WFM1/WFM2/FMST modes). There are five (5) recording memory channels.

Notes:

- FM stereo signals are recorded in mono.
- In the ISB mode, both sideband signals are mixed and recorded.

- In the CW mode, signals are recorded as mono.
- Quality of playback sound may be degraded as compared with the original signals even if recorded in the WFM mode or WAM mode.
- The receive mode should not be changed during the recording process.
- Never turn the main power switch off during recording, or loss of the recorded signal will result.
- To play back the recorded signal properly, select the same receive mode as when signals were recorded.
- When DVR memory channels are all full, no further recording can be done.

8-2-1 Recording

1. Press the  key to start recording.
2. The DVR will capture data beginning 6 seconds prior to the record key being pressed.
3. A red bullet and a white recording progress indicator will appear on the LCD.

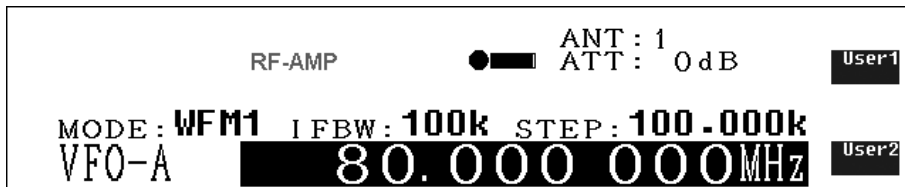



8-2-2 Stop recording

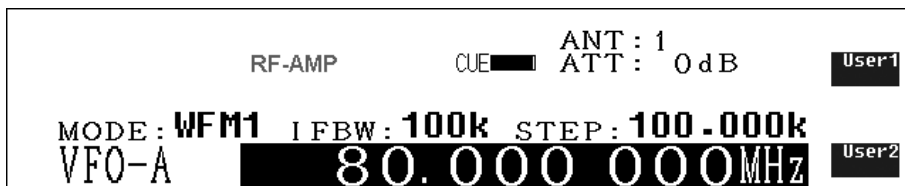





1. Press the  key while recording.
2. The red round icon will be changed to **CUE**.



8-2-3 Playback audio

1. Press the  key, then press the  key.
2. The color of the soft keys will change.
Clear blue --- Recorded (saved)
Dark blue --- Channel not used (empty)

(Example)

	Channel 0	Grey	Recorded
	Channel 1	Blue	Empty
	Channel 2	Blue	Empty
	Channel 3	Blue	Empty
	Channel 4	Blue	Empty
	Channel 5	Blue	Empty

3. Press the desired (recorded) channel soft key to play back audio.
(On the above example, the  key is available for playback.)

- The **CUE** icon will change to a green triangle icon indicating playback has taken place.
- To stop playback, press the **CLR** key.

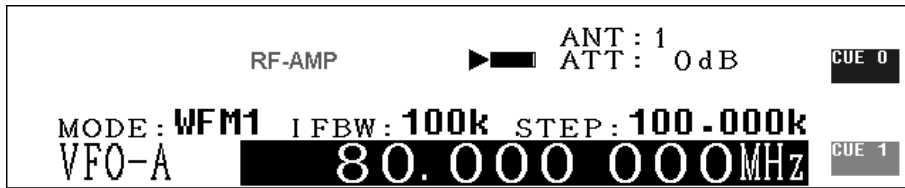

8-2-4 Changing recorded channel

Recording always takes place on channel 0. To save a recording to memory, the memory contents need to be moved to another vacant channel.

(Caution: Turning the main power switch off (on the rear panel) will delete all DVR memory contents.)

- Press the **FUNC** key, then press the **6** key.
- The data editor screen will appear.
CUE DATA MOVE 0 => 1 --- move memory contents to channel 1.
- To change (select) memory channel, rotate the sub dial and validate with the ENT key.

```

Data Editor
  (Mode / Copy)
MEM BANK MOVE  00  00
MEM BANK COPY  00  00
SRCH BANK MOVE 00  00
SRCH BANK COPY 00  00
MEM CH MOVE    00-00  00-00
MEM CH COPY    00-00  00-00
SCAN GR. MOVE  00  00
SCAN GR. COPY  00  00
SRCH GR. MOVE  00  00
SRCH GR. COPY  00  00
CUE DATA MOVE 0 => 1

              (Delete)
MEM BANK DEL  00
SRCH BANK DEL 00
MEM CH DEL    00-00
MEM PASS CH ALL 00
SRCH PASS CH ALL 00
MEM BANK ALL  OK
SRCH BANK ALL  OK
CUE DATA DEL  1
CUE DATA ALL  OK
  
```

8-3 Data Editor

Various data entries including memory channel, memory bank, search bank can be edited on this screen.

To enter the Data Editor screen, press the **FUNC** key, then press the **6** key.

The following screen will appear:

Data Editor

(Mode / Copy)		(Delete)	
MEM BANK MOVE	00	00	MEM BANK DEL 00
MEM BANK COPY	00	00	SRCH BANK DEL 00
SRCH BANK MOVE	00	00	MEM CH DEL 00-00
SRCH BANK COPY	00	00	MEM PASS CH ALL 00
MEM CH MOVE	00-00	00-00	SRCH PASS CH ALL 00
MEM CH COPY	00-00	00-00	MEM BANK ALL OK
SCAN GR. MOVE	00	00	SRCH BANK ALL OK
SCAN GR. COPY	00	00	CUE DATA DEL 1
SRCH GR. MOVE	00	00	CUE DATA ALL OK
SRCH GR. COPY	00	00	
CUE DATA MOVE	0 => 1		

(MOVE / COPY)

MEM BANK MOVE
MEM BANK COPY
SRCH BANK MOVE
SRCH BANK COPY
MEM CH MOVE
MEM CH COPY
SCAN GR. MOVE
SCAN GR. COPY
SRCH GR. MOVE
SRCH GR. COPY
CUE DATA MOVE

Move / copy

Move memory bank
Copy memory bank
Move search bank
Copy search bank
Move memory channel
Copy memory channel
Move scan group
Copy scan group
Move search group
Copy search group
Move recorded audio

Move contents of memory bank.
Copy contents of memory bank.
Move contents of search bank.
Copy contents of search bank.
Move contents of memory channel.
Copy contents of memory channel.
Move contents of scan settings.
Copy contents of scan settings.
Move contents of search settings.
Copy contents of search settings.
Move recorded audio on channel 0.

(Delete)

MEM BANK DEL
SRCH BANK DEL
MEM CH DEL
MEM PASS CH ALL
SRCH PASS CH ALL
MEM BANK ALL
SRCH BANK ALL
CUE DATA DEL
CUE DATA ALL

Delete

Delete memory bank
Delete search bank
Delete memory channel
Delete pass memory ch.
Delete search pass freq.
Delete all memory banks
Delete all search banks
Delete recorded audio
Delete all recorded audio

Delete contents of memory bank.
Delete contents of search bank.
Delete contents of memory channel.
Delete all pass memory channels.
Delete all search pass frequencies.
Delete all memory banks.
Delete all search banks.
Delete recorded audio contents.
Delete all recorded audio channel contents.

8-3-1 Moving memory bank

1. Press the **FUNC** key, then press the **6** key.
2. The data editor screen will appear.
3. Using the **↑** key or **↓** key, move the cursor to **MEM BANK MOVE**.

```
MEM BANK MOVE    00    00
```

4. The highlighted (in reverse color) number on the left side is the original memory bank.

```
MEM BANK MOVE    01    01
```

5. Rotate the sub dial to select the memory bank. (Above example shows bank 01).
6. Press the  key to move the cursor.

MEM BANK MOVE 0 1 **0 1**





7. Rotate the sub dial to select the desired memory bank.

MEM BANK MOVE 0 1 **0 2**

8. Press the  key to confirm entry.
9. At this point, the data on bank 01 is deleted and moved to bank 02.
10. The screen will return to the previous display screen.

(Note: If memory bank protection is set to ON, the memory contents will not be transferred.)

8-3-2 Copying memory bank

1. Press the  key, then press the  key.
2. The data editor screen will appear.
3. Using the  key or  key, move the cursor to **MEM BANK COPY**.

MEM BANK COPY **0 0** 0 0

4. The highlighted (in reverse color) number on the left side is the original memory bank.

MEM BANK COPY **0 1** 0 1

5. Rotate the sub dial to select the memory bank. (Above example shows bank 01).
6. Press the  key to move the cursor.





MEM BANK COPY 0 1 **0 1**

7. Rotate the sub dial to select the memory bank to be copied.

MEM BANK COPY 0 1 **0 2**

8. Press the  key to confirm entry.
9. At this point, the data of bank 01 is copied to bank 02.
10. The screen will return to the previous display screen.

8-3-3 Moving search bank

1. Press the  key, then press the  key.
2. The data editor screen will appear.
3. Using the  key or  key, move the cursor to **SRCH BANK MOVE**.

SRCH BANK MOVE **00** 00

4. The highlighted (in reverse color) number on the left side is the original search bank.

SRCH BANK MOVE **01** 01

5. Rotate the sub dial to select the memory bank. (Above example shows bank 01).
6. Press the  key to move the cursor.





SRCH BANK MOVE 01 **01**

7. Rotate the sub dial to select the desired search bank.

SRCH BANK MOVE 01 **02**

8. Press the  key to confirm entry.
9. At this point, the data of bank 01 is deleted and moved to bank 02.
10. The screen will return to the previous display screen.

8-3-4 Copying search bank

1. Press the  key, then press the  key.
2. The data editor screen will appear.
3. Using the  key or  key, move the cursor to **SEARCH BANK COPY**.

SRCH BANK COPY **00** 00

- The highlighted (in reverse color) number on the left side is the original search bank.

SRCH BANK COPY 01 01

- Rotate the sub dial to select the search bank. (Above example shows bank 01).

- Press the  key to move the cursor.





SRCH BANK COPY 01 01

- Rotate the sub dial to select the memory bank to be copied.

SRCH BANK COPY 01 02

- Press the  key to confirm entry.
- At this point, the data of bank 01 is copied to bank 02.
- The screen will return to the previous display screen.

8-3-5 Moving memory channel

- Press the  key, then press the  key.
- The data editor screen will appear.
- Using the  key or  key, move the cursor to **MEM CH MOVE**.

MEM CH MOVE 00-00 00-00

- The highlighted (in reverse color) number on the left side is the original memory bank.

MEM CH MOVE 00-04 00-00

- Rotate the sub dial to select the memory bank. (Above example shows bank 00, channel 04).
- Press the  key to move the cursor.





MEM CH MOVE 00-04 00-00

- Rotate the sub dial to select the desired memory bank and channel.

MEM CH MOVE 00-04 01-00

8. Press the  key to confirm entry.
9. At this point, the data of bank 00, channel 04 is deleted and moved to bank 01, channel 00.
10. The screen will return to the previous display screen.

8-3-6 Copying memory channel

1. Press the  key, then press the  key.
2. The data editor screen will appear.
3. Using the  key or  key, move the cursor to **MEM CH COPY**.

MEM CH COPY **00-00** 00-00

4. The highlighted (in reverse color) number on the left side is the original memory bank and channel.

MEM CH COPY **00-04** 00-00

5. Rotate the sub dial to select the search bank. (Above example shows bank 00, channel 04).
6. Press the  key to move the cursor.





MEM CH COPY 00-04 **00-00**

7. Rotate the sub dial to select the memory bank and channel to be copied.

MEM CH COPY 00-04 **01-00**

8. Press the  key to confirm entry.
9. At this point, the data of bank 00 channel 04 is copied to bank 01, channel 00.
10. The screen will return to the previous display screen.

8-3-7 Moving scan group data

1. Press the  key, then press the  key.
2. The data editor screen will appear.
3. Using the  key or  key, move the cursor to **SCAN GR. MOVE**.

SCAN GR. MOVE **00** 00

- The highlighted (in reverse color) number on the left side is the original scan bank group (00).

SCAN GR. MOVE 01 00

- Rotate the sub dial to select the scan bank group. (Above example shows bank 01).

- Press the  key to move the cursor.





SCAN GR. MOVE 01 00

- Rotate the sub dial to select the desired scan bank.

SCAN GR. MOVE 01 02

- Press the  key to confirm entry.
- At this point, the data of bank 01 is deleted and moved to bank 02.
- The screen will return to the previous display screen.

8-3-8 Copying scan group data

- Press the  key, then press the  key.
- The data editor screen will appear.
- Using the  key or  key, move the cursor to **SCAN GR. COPY**.

SCAN GR. COPY 00 00

- The highlighted (in reverse color) number on the left side is the original memory bank and channel.

SCAN GR. COPY 02 00

- Rotate the sub dial to select the search bank. (Above example shows bank 02).
- Press the  key to move the cursor.

SCAN GR. COPY 02 00

7. Rotate the sub dial to select the desired scan bank.

SCAN GR. COPY 0 2 0 3

8. Press the key to confirm entry.
9. At this point, the data of bank 02 is copied to bank 03.
10. The screen will return to the previous display screen.

8-3-9 Moving search group data

1. Press the key, then press the key.
2. The data editor screen will appear.
3. Using the key or key, move the cursor to **SRCH GR. MOVE**.

SRCH GR. MOVE 0 0 0 0

4. The highlighted (in reverse color) number on the left side is the original scan bank group (00).

SRCH GR. MOVE 0 1 0 0

5. Rotate the sub dial to select the scan bank group. (Above example shows bank 01).
6. Press the key to move the cursor.

SRCH GR. MOVE 0 1 0 0



7. Rotate the sub dial to select the desired scan bank.

SRCH GR. MOVE 0 1 0 2

8. Press the key to confirm entry.
9. At this point, the data of bank 01 is deleted and moved to bank 02.
10. The screen will return to the previous display screen.

8-3-10 Copying search group

1. Press the key, then press the key.

- The data editor screen will appear.
- Using the  key or  key, move the cursor to **SRCH GR. COPY**

SRCH GR. COPY **00** 00

- The highlighted (in reverse color) number on the left side is the original memory bank and channel.

SRCH GR. COPY **02** 00

- Rotate the sub dial to select the search bank. (Above example shows bank 02).
- Press the  key to move the cursor.





SRCH GR. COPY 02 **00**

- Rotate the sub dial to select the desired scan bank.

SRCH GR. COPY 02 **03**

- Press the  key to confirm entry.
- At this point, the data of bank 02 is copied to bank 03.
- The screen will return to the previous display screen.

8-3-11 Moving recorded voice data

- Press the  key, then press the  key.
- The data editor screen will appear.
- Using the  key or  key, move the cursor to **QUE DATA MOVE**.

CUE DATA MOVE 0 => **1**





- Voice data is always recorded on CUE channel 0. In order to save voice data, it must be copied onto CUE1~CUE5.

CUE DATA MOVE 0 => **2**

- Rotate the sub dial to select the new voice memory channel. (Above example shows channel 02).

6. Press the  key to move the cursor.
7. The screen will return to the previous display screen.

8-3-12 Deleting memory bank



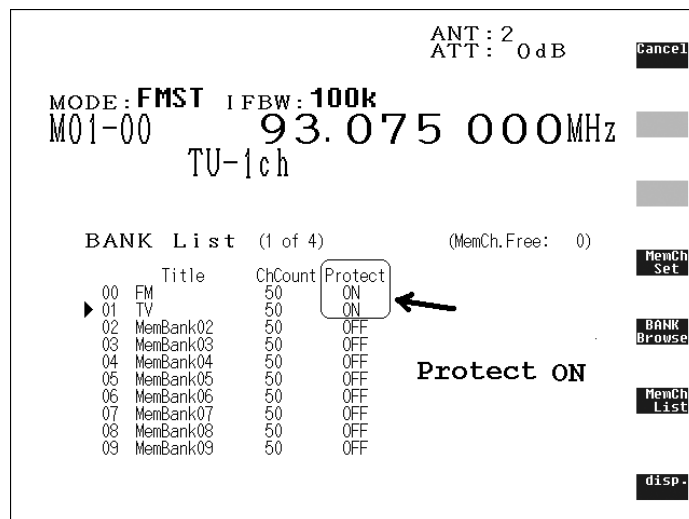

1. Press the  key, then press the  key.
2. The data editor screen will appear.
3. Using the  key or  key, move the cursor to **MEM BANK DEL**.

MEM BANK DEL **01**

4. Rotate the sub dial to select the desired memory bank to delete.
 5. Press the  key to delete the memory bank.
- (Note: In order to delete the memory bank, write protection of the memory bank must be set to OFF).



8-3-13 Deleting search bank

1. Press the  key, then press the  key.
2. The data editor screen will appear.
3. Using the  key or  key, move the cursor to **SRCH BANK DEL**.

SRCH BANK DEL **00**

4. Rotate the sub dial to select the search bank to be deleted.
5. Press the  key to delete.

8-3-14 Deleting memory channel

1. Press the **FUNC** key, then press the **6** key.
2. The data editor screen will appear.
3. Using the **↑** key or **↓** key, move the cursor to **MEM CH DEL**.

MEM CH DEL 01-05

4. Rotate the sub dial to select the memory channel to be deleted.
5. Press the **MHz** key to delete.

8-3-15 Deleting memory pass channel

1. Press the **FUNC** key, then press the **6** key.
2. The data editor screen will appear.
3. Using the **↑** key or **↓** key, move the cursor to **MEM PASS CH ALL**.

MEM PASS CH ALL 01

4. Rotate the sub dial to select the memory bank for the memory pass channels.
5. Press the **MHz** key to delete all memory pass channels.

8-3-16 Deleting all search pass channels



1. Press the **FUNC** key, then press the **6** key.
2. The data editor screen will appear.
3. Using the **↑** key or **↓** key, move the cursor to **SRCH PASS CH ALL**.

SRCH PASS CH ALL 01

4. Rotate the sub dial to select the search bank for the search pass channels.
5. Press the **MHz** key to delete.

8-3-17 Deleting all memory banks





1. Press the **FUNC** key, then press the **6** key.
2. The data editor screen will appear.

- Using the  key or  key, move the cursor to **MEM BANK ALL**.

MEM BANK ALL 

- Press the  key to delete all memory banks.





8-3-18 Deleting all search banks

- Press the  key, then press the  key.
- The data editor screen will appear.
- Using the  key or  key, move the cursor to **SRCH BANK ALL**.

SRCH BANK ALL 

- Press the  key to delete all search banks.





8-3-19 Deleting voice record channel

- Press the  key, then press the  key.
- The data editor screen will appear.
- Using the  key or  key, move the cursor to **CUE DATA DEL**.

CUE DATA DEL 

- Rotate the sub dial to select the voice record channel.
- Press the  key to delete.

8-3-20 Deleting all recorded voice data

- Press the  key, then press the  key.
- The data editor screen will appear.
- Using the  key or  key, move the cursor to **CUE DATA ALL**.

CUE DATA ALL 

- Press the  key to delete all recorded voice data.

8-4 Configuration settings

The configuration menu is used to set fundamental operating parameters and other variables which do not appear in any menu heading.

1. Press the **FUNC** key, then press the **7** key.
2. The configuration screen will appear.

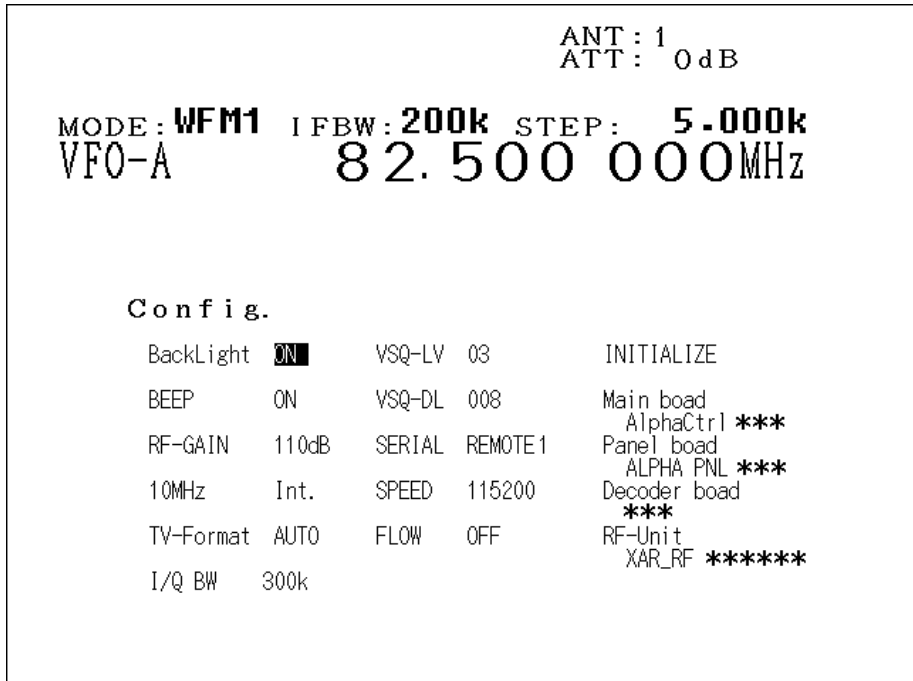





The description of each menu is as follows:

BackLight	Backlight On/Off of the display
BEEP	Beep On/Off
RF-GAIN	RF gain setting
10 MHz	Reference oscillator input select
TV-Format	Video format select
I/Q BW	I/Q output bandwidth setting
VSQ-LV	Voice squelch level setting
VSQ-DL	Voice squelch delay setting
SERIAL	Serial port select
SPEED	Serial port baud rate setting
FLOW	Serial port flow control setting
Main board	Firmware version of the main (control) board (user upgradeable)
Panel board	Firmware version of the control panel (user upgradeable)
Decoder board	Firmware version of the decoder board (user upgradeable)
RF-Unit	Firmware version of the RF Unit (hard coded to chip)





8-4-1 Configure backlit illumination

The AR-ALPHA is equipped with a high density backlight lamp to illuminate the LCD when operating.

To configure backlight illumination, perform the following steps:

1. Press the  key, then press the  key.
2. The configuration screen will appear.
3. Press the  key or  key to move the cursor to **BackLight**
4. Rotate the sub dial to select on or off.
5. Press the  key to confirm entry.

When the back light of the display is set to off, the LCD screen is invisible and may be difficult to operate. If you wish to set the display on again, please perform the following procedures:





1. Press and hold the  key to power off the unit. Wait about 10 seconds.
2. Press the  key, then press the  key.
3. Rotate the sub dial clockwise with one click. Press the  key.

(Note: The brightness of the LCD is not adjustable.)

8-4-2 Configure beep

The AR-ALPHA emits confirmation ‘beeps’ when the keypad is used. A ‘HIGH’ pitched beep indicates correct operation while a ‘LOW’ pitched beep indicates that an error or unexpected entry has taken place. The volume of the beep is independent of the main volume control. It is recommended that the beep function be enabled, especially when a new user is becoming familiar with the AR-ALPHA.

To access the configuration menu, perform the following steps:

1. Press  key, then press the  key.
2. The configuration screen will appear.
3. Press the  key or  key to move the cursor to **BEEP**.
4. Rotate the sub dial to select on or off.
5. Press the  key to confirm entry.

8-4-3 Configure RF-GAIN (Radio Frequency Gain)

The RF gain setting switches the attenuator or preamplifier to suit the band conditions and antenna in use. The value can be adjusted according to local receiving conditions.

To access the configuration menu, perform the following steps:

1. Press the **FUNC** key, then press the “MODE” key.
2. The “D.Option settings” menu will appear.
3. Press the **↑** key or **↓** key to move the cursor to AGC.
4. Rotate the sub dial to set the AGC to OFF.
5. Press the **MHz** key to confirm entry.

The SQUELCH dial now does control the RF-GAIN.

8-4-4 Configure reference signal input

This function enables you to select an external reference signal for the AR-ALPHA. The AR-ALPHA has a stable built-in reference oscillator, however, an external high stability 10 MHz reference (such as off-air, atomic coupled) can be accepted by the BNC connector, marked “10 MHz”, on the rear panel of the AR-ALPHA.

External 10 MHz external reference oscillator input

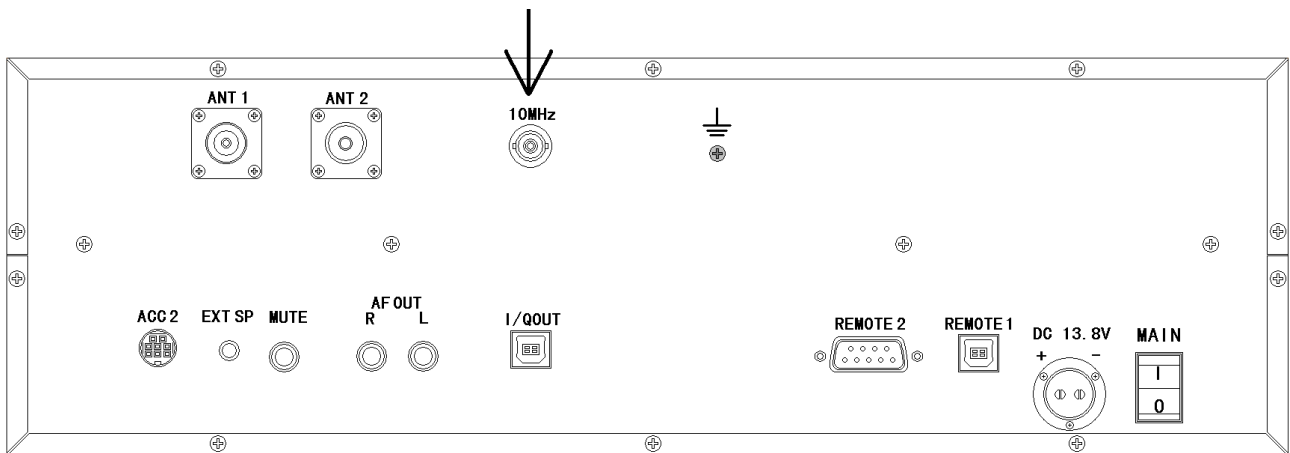

To access the configuration menu, perform the following steps:

1. Press the **FUNC** key, then press the **7** key.
2. The configuration screen will appear.
3. Press the **↑** key or **↓** key to move the cursor to **10 MHz**.
4. Rotate the sub dial to select Int. (Internal oscillator) or Ext. (External oscillator).
5. Press the **MHz** key to confirm entry.

(Caution) When the external input reference oscillator is selected but no signal is present at the 10 MHz input connector, the AR-ALPHA will not operate properly.

8-4-5 Video display & format





The AR-ALPHA has a built-in video decoder and supports NTSC, PAL, and SECAM formats.

To enable video reception, from the VFO mode press the “FUNC” key followed by the “disp” soft key.

To switch to full screen, press again the “disp” soft key. Press once again the same soft key to revert to the small video format.

The video signal format is automatically detected, however you can force the format detection in the configuration menu.

To access the configuration menu, perform the following steps:

1. Press the  key, then press the  key.
2. The configuration screen will appear.
3. Press the  key or  key to move the cursor to **TV-Format**.
4. Rotate the sub dial to choose one from the following three (3) choices.

AUTO Video mode is automatically selected.



PAL PAL mode

NTSC NTSC mode

(Note: To receive SECAM format, select AUTO mode or PAL mode.)

5. Press the  key to confirm entry.

(Note) Some video transmitters utilize reversed frequency shift modulation in order to scramble signals. If that is the case, a signal can be descrambled by changing the shift direction. To do this, perform the following steps:

1. Set the AR-ALPHA in the VFO browser mode by pressing the “disp” soft key followed by the “VFO Browse” soft key.
2. Press the  key or  key to move the cursor to **IF-Inv**.
3. Select On (reverse shift) or OFF (normal shift).
4. Press the  key to confirm entry.

8-4-6 Configure I/Q output bandwidth

The AR-ALPHA has a built-in I/Q output. This allows the user to obtain raw frequency data from the AR-ALPHA and save onto a PC hard disk.

In order to use the I/Q output function, you must have an operating system that is compatible with Isochronous mode and USB 2.0 format.

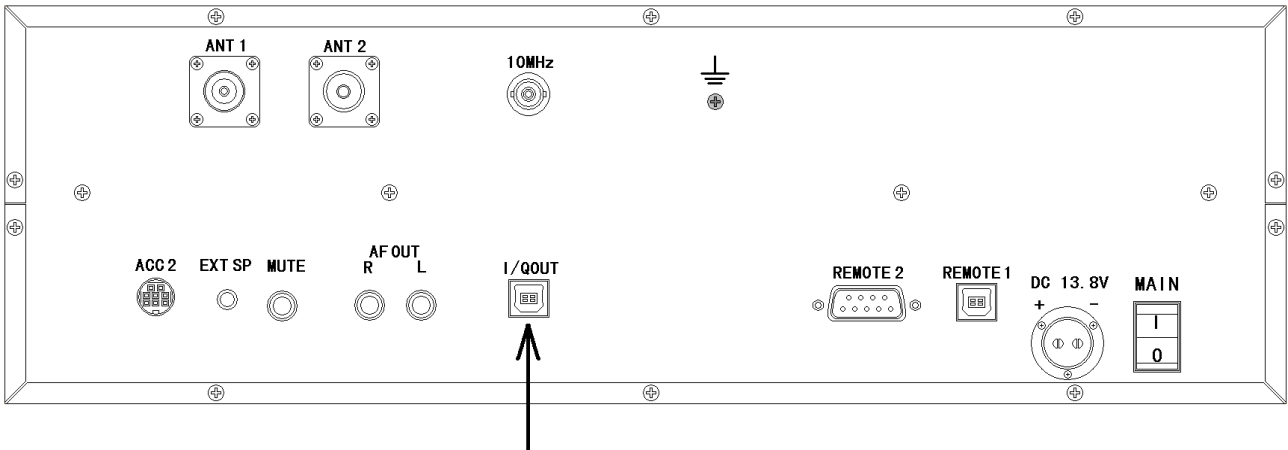

I/Q OUTPUT CONNECTOR

To access the configuration menu, perform the following steps:

1. Press the **FUNC** key, then press the **7** key.
2. The configuration screen will appear.
3. Press the **↑** key or **↓** key to move the cursor to **I/Q BW**.
4. Rotate the sub dial to select either 300K or 1M.

300K --- I/Q bandwidth 300 kHz

1M --- I/Q bandwidth 1 MHz

5. Press the **MHz** key to confirm entry.

8-4-7 Configure Voice squelch level

The voice squelch determines the way in which an active channel is determined, by sampling the audio modulation. When the voice squelch function is activated, the squelch will open only when a signal has modulation (such as voice) present.

Before this function is activated, the squelch level and time delay need to be set.

To access the configuration menu, press the **FUNC** key, then press the **2** key.

The **VSQ** icon will appear on the first row of the LCD screen.

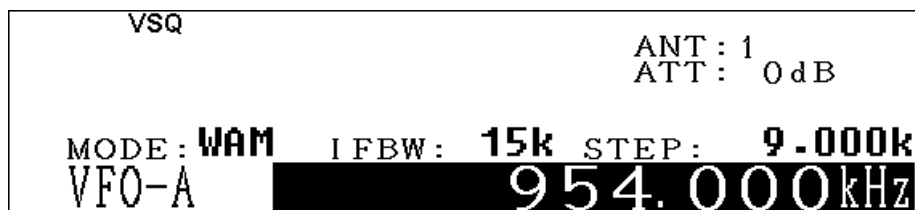

8-4-7-1 Configure Voice level and delay time

1. Press the **FUNC** key, then press the **7** key.
2. The configuration screen will appear.
3. Press the **↑** key or **↓** key to move the cursor to **VSQ-LV**.
4. Rotate the sub dial to select the voice level between 00 ~ 07. (Default value is 03.)
5. Then configure the delay time.
6. Using the **↑** key or **↓** key, move the cursor to **VSQ-DL**.
7. Rotate the sub dial to set the time delay parameter between 000 ~ 255. (Default value is 008).
8. Press the **MHz** key to confirm entry.

(Note) VSQ-LV (squelch level) and VSQ –DL (delay time) may be set independently.

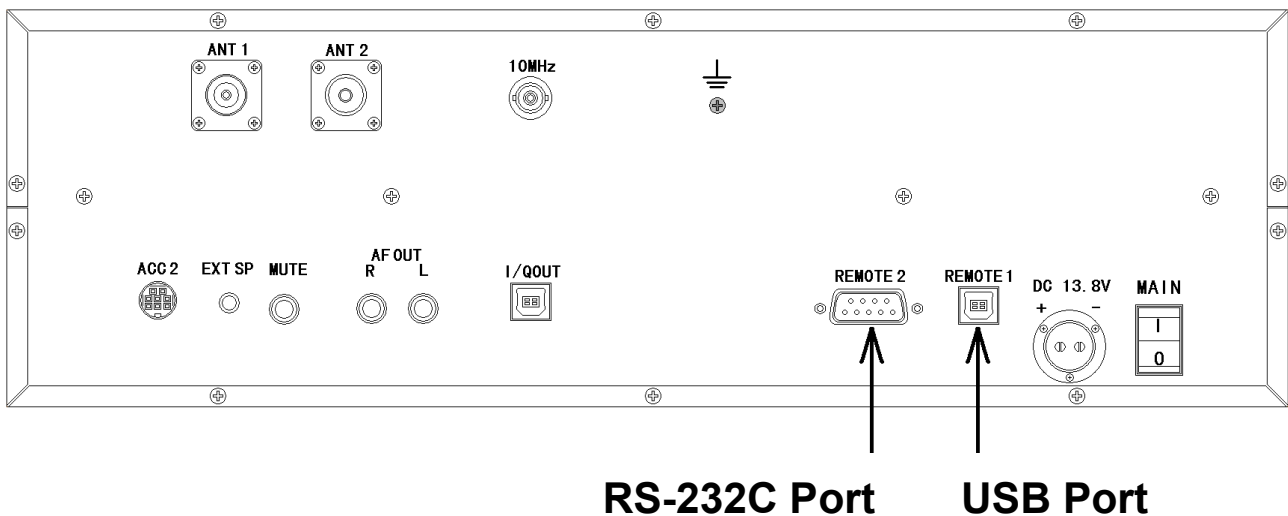

8-4-8 Configure PC interface

The AR-ALPHA has one USB interface (REMOTE 1) and one RS-232C (REMOTE 2) serial interface.
(Note: REMOTE 1 and REMOTE 2 cannot be used at the same time.)



To access the configuration menu, perform the following steps:

1. Press the **FUNC** key, then press the **7** key.
2. The configuration screen will appear.
3. Press the **↑** key or **↓** key to move the cursor to **SERIAL**.
4. Rotate the sub dial and select REMOTE 1 (USB) or REMOTE 2 (USB).
5. Press the **↓** key to move the cursor to **SPEED**.

6. Rotate the sub dial to select the communications baud rate.
The selectable parameters are 9600/19200/38400/57600/115200 baud.
7. Press the  key to move the cursor to **FLOW** (Flow control by the PC).
8. Rotate the sub dial to select flow control on or off.
9. Press the  key to confirm entry.

(Note) SERIAL, SPEED, FLOW may be set independently.

8-4-9 Configure Sleep Timer

The AR-ALPHA has a sleep timer function where the receiver may be programmed to switch off after a preset time (1 to 98 minutes).

To access the configuration menu, perform the following steps:

(Example: Setting timer for 30 minutes)

1. Press the  key, then press the "SLEEP" key.
2. The timer display will appear on the top right corner of the display.

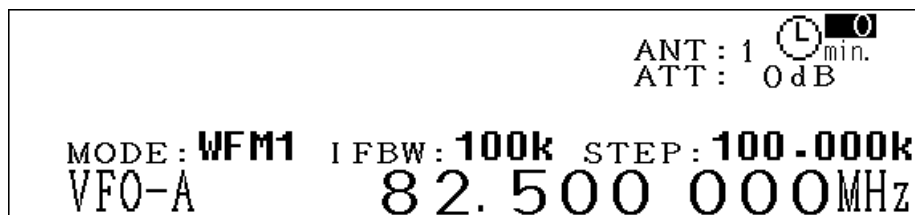

3. Rotate the sub dial to set the timer to 30 (minutes.)

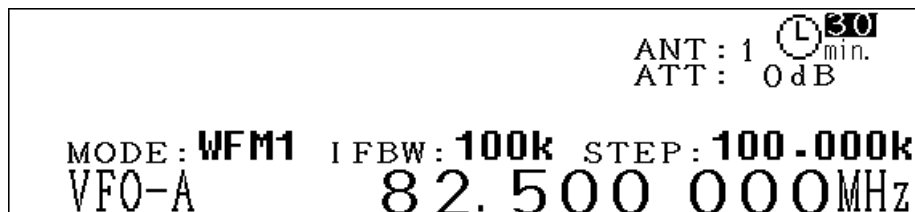

4. Press the  key to activate the sleep timer.

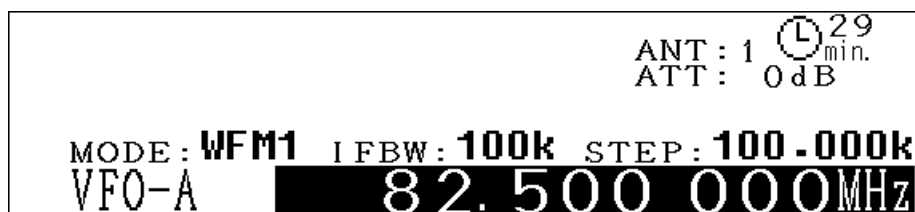

When the remaining time reaches 10 minutes, the color of timer icon will change to yellow.
When the remaining time reaches 2 minutes, the color of timer icon will change to red.

When the remaining time is less than one minute, the timer will display the remaining time.

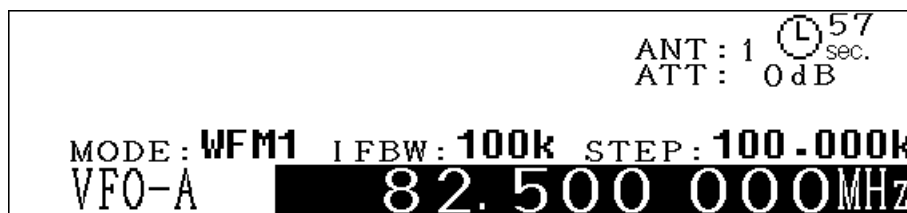

5. When the power switch is turned off manually, or by the sleep timer, the timer will be reset.

8-4-10 Configure Priority function

The priority function enables you to carry on scanning or monitoring while the AR-ALPHA periodically checks a selected frequency for activity.

8-4-10-1 Setup

The priority can be accessed from either the VFO mode or the memory read mode.

1. Press the key, then press and hold the key for 2 seconds.
2. The PRIO (Priority Setting) sub screen will appear on the LCD.

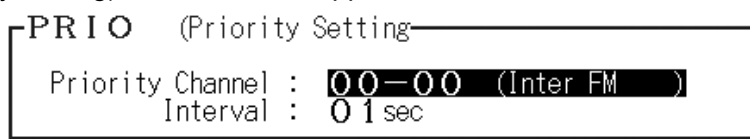

3. Rotate the sub dial to select the priority channel.

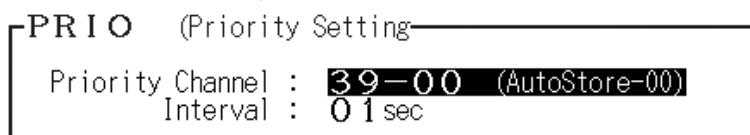

4. Press the key, then set the time interval between 01 ~ 88 (seconds).

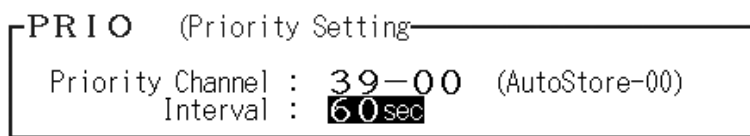

5. Press the key to confirm entry.

8-4-10-2 Activating priority function

To activate the priority function, perform the following steps:

1. Press the key, then press the key.

- The PRIO icon will appear at the top of the LCD.

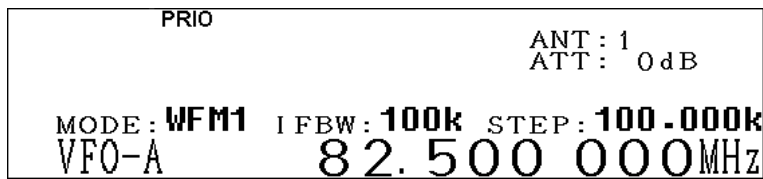

- When the priority channel is received, the priority channel number will be displayed.



- To deactivate the priority function, repeat above steps.

9. Computer control

Connect a PC to the AR-ALPHA using one of the remote control connectors.

REMOTE 1 is for USB interface (USB-B type) and REMOTE 2 is a serial port using an RS-232C cable terminated in a 9-pin plug. The default setting is REMOTE 2 (SERIAL).

9-1 How to send a control command

Each command consists of two upper case letters (header) along with operations as required. All commands use ASCII code which **MUST BE IN UPPER CASE** (except for the up arrow key, down arrow key, right arrow key, left arrow key).

A terminal program running on the computer should be set to:

Baud rate:	115200 bps (this should match the AR-ALPHA setting)
DATA BIT:	8
STOP BIT:	1
PARITY:	NONE
XFLOW:	NONE

A multiple command entry is only valid where specified. Where a multiple command entry is allowed, each command **MUST** be separated with a space "h20" (HEX DECIMAL). Each command is completed and a [CR] or [CR][LF]. Although there is no local echo, either [CR] or a specified response should come back from the receiver after confirming the correct command. If no response has been received after a short time, the receiver has failed to receive the command properly. Send a [CR] then re-send the command. Should a problem persist, check your connections or try reducing the baud rate.

9-2 Powering on the AR-ALPHA

Connect a remote cable between the AR-ALPHA and a PC, type any key to power up the AR-ALPHA.

9-3 Detailed control command listings for the AR-ALPHA

^A AC AF AG

Remote power on

^Ann	Remote ON	Hex value 0x01 Accept a value nn in the range of 00-99 for remote connection
-------------	-----------	---

AGC

AC	ACn (n: 0 ~ 3)	n = 0 (AGC Fast) n = 1 (AGC Middle) n = 2 (AGC Slow) n = 3 (Manual gain control)
To read: AC <CR>		
Response: ACn		

AFC

AF	AFn	n = 0 (AFC off) n = 1 (AFC on)
To read: AF <CR>		
Response: AFn		

AF gain

AG	AGnn	n = 0 ~ 255 (n: 0 = mute, no audio)
To read: AG <CR>		
Response: AGn		

AN AQ AS AT

Antenna input

AN	ANn (n: 1 ~ 4)	
	n = 1	Antenna input 1
	n = 2	Antenna input 2
	n = 3	Antenna input 3 (An optional antenna relay is required.)
	n = 4	Antenna input 4 (An optional antenna relay is required.)
To read: AN <CR>		
Response: ANn		

Audio output select

AQ	AQn (n: 0, 1)
	n = 0 Output : audio output
	n = 1 Output : I/Q output
To read: AQ <CR>	
Response: AQn	

Auto store (Cannot be used alone)

AS	ASn (n: 0, 1)
	n = 0 Auto store off
	n = 1 Auto store on
Cannot be used alone. Use as a parameter of the SG command	

Attenuator, Preamplifier

AT	ATn (n: 0 ~ 4)
	n = 0 Attenuator 0 dB, Preamplifier on
	n = 1 Attenuator 0 dB, Preamplifier off
	n = 2 Attenuator 10 dB, Preamplifier off
	n = 3 Attenuator 20 dB, Preamplifier off
	n = 4 AUTO
To read: AT <CR>	
Response: AT00 Attenuator 0 dB, Preamplifier on AT01 Attenuator 0dB, Preamplifier off AT02 Attenuator 10dB, Preamplifier off AT03 Attenuator 20dB, Preamplifier off AT11 Auto Attenuator 0 dB, Preamplifier off AT12 Auto Attenuator 10 dB, Preamplifier off AT13 Auto Attenuator 20 dB, Preamplifier off	

Auto mode

AU	AUn (n = 0, 1)
	n = 0 Auto mode off
	n = 1 Auto mode on
To read: AU <CR>	
Response: AUn	

Bank link (Cannot be used alone)

BK	Specify the bank to link
Cannot be used alone. Use as the parameter of the SG/MG command	

Backlit display

BL	BLn (n = 0, 1)
	n = 0 Backlit off
	n = 1 Backlit on
To read: BL <CR>	
Response: BLn	

BP CF CL CN

Beep

BP	BPn (n = 0, 1)
	n = 0 Beep off
	n = 1 Beep on
To read: BP <CR>	
Response: BPn	

Set Center frequency (in Channel scope mode)

CF	Specify the center frequency
To read: CF <CR>	

Remote control port

CL	CLn (n = 0, 1)
	n = 0 REMOTE 1 USB
	n = 1 REMOTE 2 RS-232C
To read: CL <CR>	
Response: CL n	

Tone squelch

CN	CNnn (n = 00 ~ 53)
To read: CN <CR>	
Response: CNnn	

	0	1	2	3	4	5	6	7	8	9
0	OFF	ALL	60.0	67.0	69.3	71.9	74.4	77.0	79.7	82.5
1	85.4	88.5	91.5	94.8	97.4	100.0	103.5	107.2	110.9	114.8
2	118.8	120.0	123.0	127.3	131.8	136.5	141.3	146.2	151.4	156.7
3	159.8	162.2	165.5	167.9	171.3	173.8	177.3	179.9	183.5	186.2
4	189.9	192.8	196.6	199.5	203.5	209.5	210.7	218.1	225.7	229.1
5	233.6	241.8	250.3	254.1						

Tone frequency chart

CW pitch frequency

CP	CPnn (nn: 30 ~ 50) in 5 increments (50 Hz step) (Example) nn = 30 300 Hz nn = 90 900 Hz
To read: CP <CR>	
Response: CPnn	

Delay time (cannot be used alone)

DL	DLnn (nn: 01 ~ 99)
Cannot be used alone. Use as the parameter of the MG/SG command	

DM DS DT

Calculation

DM	DMn or DMmmm (n: 0 ~ 3 Specify the calculation mode) n = 0 Calculation mode not used n = 1 Maximum value hold mmm = 202 ~ 231 Averaged value, specify between 02 ~ 31 mmm = 302 ~ 304 Median, specify between 02 ~ 04
To read: DM <CR>	
Response: DMn or DMmmm	

DCS (Digital Code Squelch)

DS	DSnnn (n: 000 ~ 999)
	n = 000 DCS off
	n = 999 All codes
To read: DS <CR>	
Response: DSnnn	

017	023	025	026	031	032	036	043	047	050
051	053	054	065	071	072	073	074	114	115
116	122	125	131	132	134	143	145	152	155
156	162	165	172	174	205	212	223	225	226
243	244	245	246	251	252	255	261	263	265
266	271	274	306	311	315	325	331	332	343
346	351	356	364	365	371	411	412	413	423
431	432	445	446	452	454	455	462	464	465
466	503	506	516	523	526	532	546	565	606
612	624	627	631	632	654	662	664	703	712
723	731	732	734	743	754				

DCS Codes

DTMF (Function available in the VFO mode or memory mode)

DT	DTn (n: 0, 1)
	n = 0 DTMF off
	n = 1 DTMF on
To read: DT <CR>	
Response:	DTn

EC EF EN EX**Reference frequency input**

EC	ECn (n: 0, 1)
	n = 0 Internal
	n = 1 External
To read: EC<CR>	
Response:	ECn

End (stop) frequency input (in the channel scope mode)

EF	EFn Set end (stop) frequency
To read: EF<CR>	
Response:	EFn

De-emphasis time constant (available in the WFM1, WFM2, FMST, and FM mode)

EN	ENn (n: 0, 1) IFBW must be set more than 30 kHz
	n = 0 50 uS
	n = 1 75 uS
To read: EN<CR>	
Response:	ENn

Cancel remote operation

EX	EX
-----------	----

FE FF FP**Spectrum frequency step (in the channel scope mode)**

FE	FEn Specify the spectrum frequency step
To read: FE<CR>	
Response:	FEn

FFT search

FF	FFnn	(n: 00 ~ 39)	search bank
	FSnn	(n: 00 ~ 12)	search frequency step (see below chart)
	FTnnn	(n: -0 ~ -110)	threshold level
To read: FF<CR>			
Response: FFnn FSnn FTnnn			

Parameter	00	01	02	03	04	05	06	07	08	09	10	11	12
Step (kHz)	1.00	2.00	5.00	6.25	8.33	9.00	10.00	12.50	20.00	25.00	30.00	50.00	100.00

Search frequency step

Spectrum frequency span (in the channel scope mode)

FP	FPn	n: spectrum frequency span
To read: FP<CR>		
Response: FPn		

Search, free scan free time (Cannot be used alone)

FR	FRnn	(nn: 00 ~ 12)
Cannot be used alone Use as the parameter of the MG/SG command		

FFT search threshold level (Cannot be used alone)

FS	FSnnn	(nnn: -0 ~ -110)
Cannot be used alone Use as the parameter of the FF command		

Select memory

GA	GAn	(n: 0, 1) n = 0 Clear select memory (single channel) n = 1 Set select memory
To read: GA<CR>		
Response: GAn		

Select memory (all channels)

GD	GD	No parameter required
-----------	----	-----------------------

GN GR IF

Input sensitivity of spectrum display

GN	GNn (n: 0 ~ 5) n = 0 0 dB n = 1 -10 dB n = 2 -20 dB n = 3 -30 dB n = 4 -40 dB n = 5 -50 dB
To read: GN<CR>	
Response: GNn	

Display select channel

GR	GR no parameter required
Response: (example) GR001 MX0009 MF0082.500000 TMN HK-FM	

IFBW (IF bandwidth)

IF	IFnn (00 ~ 09) n = 00 200 Hz n = 01 500 Hz n = 02 1 kHz n = 03 3 kHz n = 04 6 kHz n = 05 15 kHz n = 06 30 kHz n = 07 100 kHz n = 08 200 kHz n = 09 300 kHz
To read: IF<CR>	
Response: IFnn	

In the CW modes (CW1 and CW2), only 200 Hz and 500 Hz are selectable.

In the WFM modes (WFM1, WFM2, and FMST), only 100 kHz, 200 kHz, and 300 kHz are selectable.

All other modes: 1 kHz, 3 kHz, 6 kHz, 15 kHz, and 30 kHz are selectable.

IQ bandwidth

IQ	IQn (n: 0, 1) n = 0 300 kHz n = 1 1 MHz
To read: IQ<CR>	
Response: IQn	

IF shift width

IS	ISnnn (nnn: -120 ~ +120) 50 Hz step, 5 increments
	nnn = -120 ~ -005 (minus shift)
	nnn = 000 (IF shift off)
	nnn = +005 ~ +120 (plus shift)
	Not available in all FM modes and RZ-SSB mode.
To read: IS<CR>	
Response: ISnnn	

Marker level continuous output

KC	KCn (n:0, 1)
	n = 0 Marker level output off
	n = 1 Marker level output on.
To read: KC<CR>	
Response: KCn	

Use the KF command for single output.

KF KG KL KY**Marker frequency and level**

KF	KFn (n: marker frequency)
	The marker frequency must be within a displayed range.
To read: KF<CR>	
Response: KFn	

Make the frequency as a receive frequency

KG	KG No parameter required
	Direct command

Key lock

KL	KLn (n: 0, 1)
	Delete all search data and pass frequencies on all search banks

Change Marker mode

KM	KMn (n: 0 ~ 2)
	n = 0 Marker frequency reading
	n = 1 Peak marker reading
	n = 2 Continuous peak reading
To read: KM<CR>	
Response: KMn	

User defined keys

KY	KYn (n: 0 – 9)
	n = 0 ~ 4 User defined key 1 ~ 5
	n = 5 ~ 9 User defined key 6 ~ 10

S-meter level

LM	LM ----- Read only (in dB)
-----------	----------------------------

Squelch setting

LQ	LQnnn (n: 000 ~ 255)
	n = 000 Open
To read: LQ<CR>	
Response: LQnnn	

Auto notch

LS	LSn (n: 0 ~ 3)
	n = 0 OFF
	n = 1 Low
	n = 2 Mid
	n = 3 High
To read: LS<CR>	
Response: LSn	

Read memory channel Read only

MA	MAMmn Read only
	mm = memory bank
	nn = memory channel

Set number of memory bank channel Cannot be used alone

MC	MCnn (n:5 ~ 95)
	Cannot be used alone. Use as the parameter of the MW command.

MD MF

Receive mode

MD	MDnn (nn: 00 ~ 39) See below chart
To read: MD<CR>	
Response: MDnn	

Simple modes

Parameter	Mode
00	FM
01	FMST
02	AM
03	SAM
04	SAL
05	SAH
06	USB
07	LSB
08	CW
09	ISB
10	SBD
11	RZ-SSB
12	AIQ

Advanced modes

Parameter	Mode	IFBW
21	WFM1	100 kHz
22	WFM2	200 kHz
23	FMST	200 kHz
24	NFM	15 kHz
25	SFM	6 kHz
26	WAM	15 kHz
27	AM	6 kHz
28	NAM	3 kHz
29	SAM	6 kHz
30	SAL	6 kHz
31	SAH	6 kHz
32	USB	3 kHz
33	LSB	3 kHz
34	CW1	500 Hz
35	CW2	200 Hz
36	ISB	6 kHz
37	SBD	6 kHz
38	RZ-SSB	3 kHz
39	AIQ	15 kHz

Set memory channel frequency (Cannot be used alone)

MF	MFn Set memory channel frequency
Cannot be used alone Use as the parameter of the MX command	

MG MP MR MS MT

Set memory scan group

MG	MGnn (nn: 00 ~ 19) scan group
	DLnn (nn: 01 ~ 99) delay setting (in 0.1 sec. increment)
	FRnn (nn: 00 ~ 99) free time nn = 00 stop (in 1 sec. increment)
	BKnn (nn: 01 ~ 19) set bank link (Example) bank link 03, 04, 05 → Input BK030405
To read: MG<CR>	
Response: MGnn DLnn FRnn BKnn	

Set pass channel

MP	MPn (n: 0, 1)
	n = 0 Pass setting off
	n = 1 Pass setting on
	MPmm (mm: 00 ~ 39)
	Cancel pass function on the pass bank
To read: MP<CR>	
Response: MPn or MPmm	

Call memory bank channel Write only

MR	MRmmnn
	mm: bank number
	nn: channel number

Call search bank Write only

MS	MSnn (nn: 00 ~ 39)
-----------	--------------------

Edit memory bank title (text) (Cannot be used alone)

MT	MTxxxxxxxxxxxxxxx xxx...: Title (text)
Cannot be used alone Use as the parameter of the MX command	

MW MX NB NR

Set memory bank

MW	MWnn (nn: 00 ~ 39) Memory bank
	MCnn (nn: 05 ~ 95) A number of channels in the memory bank
	TTxxxxxx... memory text
To read: MW<CR>	
Response: MWnn MCnn TTxxxxx.....	

Set memory channel

MX	MXmmnn set memory bank and channel (mm: bank nn: channel)
	MFnnnn.nnnnn Set frequency
	MTxxxxxx... memory text
To read: MX<CR>	
Response: MXmmnn MFnnnn.nnnnn MTxxxxx.....	

Noise blanker

NB	NBn (n: 0 ~ 3)
	n = 0 OFF
	n = 1 Low
	n = 2 Mid
	n = 3 High
To read: NB<CR>	
Response: NBn	

Noise reduction

NR	NRn (n: 0 ~ 3)
	n = 0 OFF
	n = 1 Low
	n = 2 Mid
	n = 3 High
To read: NR<CR>	
Response: NRn	

Frequency offset

OF	OFnn (n: 00 ~ 47)
	nn = 0 OFF
	nn = 01 ~ 20 User defined offset frequency Use OL command
	nn = 21 ~ 47 Preset offset frequency (See below)
	+ or - = shift direction
	OLnnn.nnnnnn Offset frequency (in MHz format)
To read: OF<CR>	
Response: OFnn or OFnn OLnnn.nnnnnn	

Parameter	Frequency	Parameter	Frequency	Parameter	Frequency
21	4.000 MHz	31	18.450 MHz	41	0.000 MHz
22	4.600 MHz	32	20.000 MHz	42	0.000 MHz
23	5.000 MHz	33	24.100 MHz	43	0.000 MHz
24	8.000 MHz	34	37.400 MHz	44	0.000 MHz
25	9.000 MHz	35	47.200 MHz	45	0.000 MHz
26	10.000 MHz	36	48.000 MHz	46	0.000 MHz
27	15.000 MHz	37	55.000 MHz	47	0.000 MHz
28	16.000 MHz	38	126.350 MHz		
29	16.500 MHz	39	130.000 MHz		
30	18.000 MHz	40	0.000 MHz		

Preprogrammed off set frequency list

User defined offset frequency (Cannot be used alone)

OL	OLnnn.nnnnn (in MHz format)
Cannot be used alone Use as the parameter of the OF command	

Display mode

OM	OMn (n: 0, 1)
	n = 0 Spectrum analyzer mode
	n = 1 Channel scope mode
To read: OM<CR>	
Response: OMn	

PD PP PR PW

Cancel pass function Write only

PD	PDmmnn specify bank number and channel number
	mmnn: mm = bank nn = channel
	%%nn: nn channel in all banks
	mm%%: all channels in mm bank
	%%: all channels in all banks
Write only	

Set priority channel

PP	PPmmnn specify bank number and channel number
	mmnn: mm = bank nn = channel
To read: PP<CR>	
Response: PPmmnn	

Display pass channel list Read only

PR	PRnn nn: bank
To read: PR<CR>	
Response: PRxxx.....	

Write pass frequency (for search mode only)

PW	PWxxx... xxxx..... : See below for details
	none: Write the current displayed frequency as a pass frequency
	00 ~ 47: specify the bank and write the frequency
	Frequency: specify the frequency and write
	%%: Write the current displayed frequency in all banks
	%%frequency: Specify the frequency and write in all banks in all modes
	Nnfrequency: Specify the bank and frequency, then write in all modes
Write only	

QM QP QR QY TI

Transfer saved voice recording memory (Write only)

QM	QMn (n: 1 ~ 5) voice recorder memory channel
	QR command save voice recorder on channel 0. It will be, however, overwritten at next recording if the memory contents are not transferred to another channel.
Write only	

Remote power off (Write only)

QP	QPnn (n: 00 ~ 99)
	nn: value of RD command Default is 00.
Write only	

Start voice recording (Write only)

QR	QR No parameter required
	Recording will start 6 seconds before executing this command.
Write only	

Playback audio f (Write only)

QR	QRn (n: none or 1 ~ 5)
	n: none stop playback n: 1 ~ 5 specify the voice memory channel..
Write only	

Set receive frequency (Write only)

RF	TInn..... (n: frequency)
	Specify the VFO frequency.
Write only. Use RX command to read the receive frequency.	

RG RS RV RW RX

Receiver gain control

RG	RGnnn (n: 000 ~ 110)
Available when the gain control is set to manual mode.	
To read: RG<CR>	
Response:	RGnnn

Reset (Write only)

RS	RS no parameter required
This initializes all parameters in the configuration menu panel to factory default.	
Write only	
RS2	RS2 no parameter required
This initializes everything except for the memory channels.	
Write only	
RS!	RS! no parameter required
This initializes everything, all settings and memories you saved will be erased.	
Write only	

VFO setting (Write only)

RV	RVn (n: A ~ D) Specify the VFO.
Write only	

RBW (Resolution bandwidth)

RW	RWn (n: 0 ~ 4)
	n = 0 RBW 1 kHz
	n = 1 RBW 4 kHz
	n = 2 RBW 32 kHz
	n = 3 RBW 64 kHz
	n = 4 RBW 128 kHz
To read: RW<CR>	
Response:	RWn

Read receiver operating conditions (Read only)

RX	RX	no parameter required
To read: RX<CR>		
Response: See below		
(Example) V0 RF0084.300000 ST100.000 AU1 MD21 AT01		
Vn: VFO mode		
0 = VFO-A 1 = VFO-B 2 = VFO-C 3 = VFO-D 4 = VFO-E		
MR MX0000 GA1 RF0082.500000 ST020.000 AU1 MD21 AT00 TMN HK		
MR: Memory mode		
MS MX0000 GA1 RF0082.500000 ST020.000 AU1 MD21 AT00 TMN HK		
MS: Memory scan mode		
SM: MX000000 GA1 RF0082.500000 ST020.000 AU1 MD21 AT00 TMN HK		
SM: Select scan mode		
SR0 RF0380.212500 ST012.500 AU1 MD25 AT00 TMCordless Phone		
SRn: Normal search mode		
FF01 FS08 FT-080		
FFnn: FFT search mode		
WS RF0084.300000 ST100.00 AU1 MD21 AT01		
WS: Wide span mode		

Serial port baud rate

SB	SBn	(n: 0 ~ 4)
	n = 0	115200 bps
	n = 1	57600 bps
	n = 2	38400 bps
	n = 3	19200 bps
	n = 4	9600 bps
To read: SB<CR>		
Response: SBn		

Voice descrambler (Not available with US consumer version)

SC	RWnnn	(nnn: 000, 200 ~ 700) (in Hz, 50 Hz step)
	nnn = 000	deactivated
	nnn = 200 ~ 700	(x 10 (Hz))
	(Example) 200	= 2000 Hz
	700	= 7000 Hz
To read: SC<CR>		
Response: SCnnn		

SE SF SG SH

Search operation settings (Write only)

SE	Set bank and configure search function
	SL = Low end of search frequency
	SU = High end of search frequency
	ST = Step frequency
	AU = 0 or 1 auto mode setting
	MD = 00 ~ 12 or 21 ~ 39 receive mode
	AT = 0 ~ 4 attenuator and preamplifier setting
	TT = up to 12 characters Bank title (text)
Use SRnn command to read settings.	

Hardware flow control (RTS/CTS)

SF	SFn (n: 0, 1)
	n = 0 Flow control off (RTS/CTS)
	n = 1 Flow control on (RTS/CTS)
To read: SF<CR>	
Response: SFn	

Normal search group settings

SG	Set bank of the normal search group
	DL = 01 ~ 99 Delay time (0.1 second step)
	FR = 00 = 60 Free time for normal search (1 sec. step)
	AS = 0, 1 Auto store function
	BK = bank set bank link
To read: SG<CR>	

Step adjust

SH	SHn (n: 0, frequency)
	n = 0 step adjust off
	n = frequency set step adjust frequency
To read: SH<CR>	
Response: SHn	

SL SM SP SR SS ST

Lower end frequency of search function (Cannot be used alone)

SL	SLn (n: frequency)
Cannot be used alone. Use as a parameter of SE command.	
Write only	

Select scan (Write only)

SM	SL no parameter required
Go into the select scan mode. Direct command.	
Write only	

Sleep timer

SP	SPnn (n: 00 ~ 99)
	n = 00 sleep timer off
	n = 01 ~ 99 (1 minute step)
To read: SP<CR>	
Response: SPnn	

Display search status (Read only)

SR	SR no parameter required
Display the designated search function.	
Read only	

(Display example)

SR00 SL380.212500 SU381.312500 ST012.500 AU1 MD25 AT00 TT Cordless

Start search (Write only)

SS	SS no parameter required
Go into the search mode. Direct command.	
Write only	

Frequency step

ST	STnnn.nnn (nnn.nnn: 000.001 ~ 999.999) in Hz
To read: ST<CR>	
Response: STnnn.nnn	

SU TF TI TT VC

Upper end frequency for search (Cannot be used alone)

SU	SUn (n: high end frequency)
Cannot be used alone. Use as the parameter of the SE command.	

Start frequency (channel scope mode)

TF	TFn	(n: start frequency)
To read: SU<CR>		
Response: SUn		

Priority time interval

TI	TInn	(nn: 00 ~ 99) in second
To read: TI<CR>		
Response: TInn		

Memory bank title (text) (Cannot be used alone)

TT	TTxx...	(xx...: memory text)
Cannot be used alone. Use as the parameter of the MW command.		

Video format

VC	VCn	(n: 0 ~ 2)
	n = 0	Auto detect
	n = 1	NTSC
	n = 2	PAL (SECAM)
To read: VC<CR>		
Response: VCn		

VD VF VI VL**IF direction**

VD	VDn	(n: 0, 1)
	n = 0	normal
	n = 1	reverse
To read: VD<CR>		
Response: VDn		

VFO select

VF	VFn	(n: A ~ E)
	n = A	VFO - A
	n = B	VFO - B
	n = C	VFO - C
	n = D	VFO - D
	n = E	VFO - E
To read: VF<CR>		
Response: VFn		

Video display

VI	VIn (n: 0, 1)
	n = 0 video display off
	n = 1 video display on
To read: VI<CR>	
Response: VIn	

Voice squelch level

VL	VLn (n: 0 ~ 7)
To read: VL<CR>	
Response: VLn	

VQ VR VT WF

Voice squelch

VQ	VQn (n: 0, 1)
	n = 0 voice squelch off
	n = 1 voice squelch on
To read: VQ<CR>	
Response: VQn	

Firmware version **(Read only)**

VR	VR no parameter required
Display the installed firmware version.	
Read only	

(Display example) CAlphaCtrl 703A D704A PALPHA PNL 703A RXAR_RF 060728

Description: C AlphaCtrl 703A = control unit
D 704A = decoder unit
P ALPHA PNL 703A = control panel unit
R XAR_RF 060728 = RF unit

Voice squelch delay

VT	VTnnn (nnn: 000 ~ 255)
To read: VT<CR>	
Response: VTnnn	

Waterfall

WF	WFn (n: 0, 1)
	n = 0 waterfall off
	n = 1 waterfall on
To read: WF<CR>	
Response: WFn	

WS ZK ZJ

Wideband display (Write only)

WS	WS	no parameter required
Write only		

Press the 'UP' arrow key (Write only)

ZK	ZK	no parameter required
Write only		

Press the 'DOWN' arrow key (Write only)

ZJ	ZJ	no parameter required
Write only		

10. SPECIFICATIONS

Configuration:	Triple conversion super heterodyne
Frequency coverage:	10 KHz ~ 3.5 GHz (Cellular blocked in US consumer version)
Receive mode:	WFM, FM-ST (FM Stereo), AM, SAM, USB, LSB, CW, ISB (Independent Sideband), SBD (Sideband Diversity), RZ-SSB (Real Zero SSB), AIQ (Analog I/Q, -- F.Y.I. Can be used as an analog output for DRM reception, 3 rd party decoding software required.), APCO-25 (P25, conventional mode), Video (NTSC, PAL, SECAM)
Sensitivity:	(AM mode, 10 dB S/N, BW = 6 KHz) 0.1 ~ 0.499 MHz : 5 μ V 0.5 ~ 1.699 MHz: 5 μ V 1.7 ~ 24.99 MHz : 2.3 μ V 25 ~ 479.99 MHz : 2.3 μ V 480 ~ 1029.99 MHz : 2.3 μ V 1030 ~ 1695.99 MHz : 1.3 μ V 1696 ~ 3300 MHz : 1.5 μ V (NFM mode, 12 dB SINAD, BW = 15 kHz) 25 ~ 479.99 MHz : 2.5 μ V 480 ~ 1029.99 MHz : 0.8 μ V 1030 ~ 1695.99 MHz : 0.8 μ V 1696 ~ 3300 MHz: 1.5 μ V (WFM mode, 12 dB SINAD, BW = 200 kHz) 25 ~ 479.99 MHz : 1.3 μ V 480 ~ 1029.99 MHz : 1.3 μ V 1030 ~ 1695.99 MHz : 1.3 μ V 1696 ~ 3300 MHz : 1.5 μ V
IF frequencies:	1 st IF: 755 MHz / 265 MHz 2 nd IF: 10.7 MHz 3 rd IF: Zero
Tuning steps:	1 Hz to 999.999 kHz incremental
Selectivity:	SSB (BW =3 kHz): more than 2.8 kHz @ -3 dB less than 3.2 kHz @ -90 dB CW (BW =500 Hz): more than 450 Hz @ -3 dB less than 550 Hz @ -90 dB AM (BW =6 kHz): more than 5.5 kHz @ -3 dB less than 7 kHz @ -90 dB FM (BW =15 kHz): more than 14 kHz @ -3 dB less than 17 kHz @ -90 dB
Spurious sensitivity:	more than 60 dB
Dynamic range:	more than 70 dB
3rd IP:	more than -1 dBm (across the entire receive range)
Frequency stability:	less than +/- 0.1 ppm (after 5 minutes of power on time)
Audio output:	For speaker: 2W @ 8 Ω for DC input 13.8V
Power requirement:	Nominal 13.8V DC, approx. 2.2A.
Antenna impedance:	50 Ω

Antenna inputs:	N, SO239
External freq. standard:	10 MHz @ 50 Ω, 0 dBm
Control interface:	RS-232C, USB
Operating temperature:	0 ~ 50°C, 32 ~ 122°F
Dimensions:	420(W)x132(H)x252(D) mm, 16.5"(W)x5.2"(H)9.9"(D) (Projections excluded)
Weight:	Approximately 7.3kg, 16.1 lb.
Filter bandwidth:	0.2, 0.5, 1, 3, 6, 15, 30, 100, 200, 300 kHz (nominal)
Memory channels:	2000 (40 banks)
Search banks:	40
Scan/search rate:	70 steps/sec
Pass frequencies:	2000
Select scan channels:	100
Priority channels:	1
LCD display:	6.4" TFT color
Display spectrum:	250 kHz to 1GHz
IQ output:	300 kHz and 1 MHz bandwidth by USB 2.0
Extended demodulation:	DCS, CTCSS, DTMF, ATIS

(Specifications are subject to change without notice or obligation.)

(Specifications are guaranteed up to 3.3 GHz operating frequency.)

11. I/Q DIGITAL OUTPUT IN DETAILS FOR DEVELOPERS

1 GENERAL

The I/Q digital output of the AR-ALPHA represents the actual signal used after digital processing in the receiver. The digital I/Q output interface streams I/Q data to the PC through USB2.0 isochronous mode, with nearly 100Mbps wide bandwidth.

A Windows XP device driver is provided free of charge for software developers, to allow them to develop their own I/Q software, or to integrate the AR-ALPHA I/Q acquisition feature to their existing software..

2 SIGNAL FLOW

In the AR-ALPHA circuitry, 10.7MHz of intermediate frequency (IF) is being sampled directly at 42.8MHz. No AGC is applied at the preceding stage in order to obtain a digital signal with wider dynamic range.

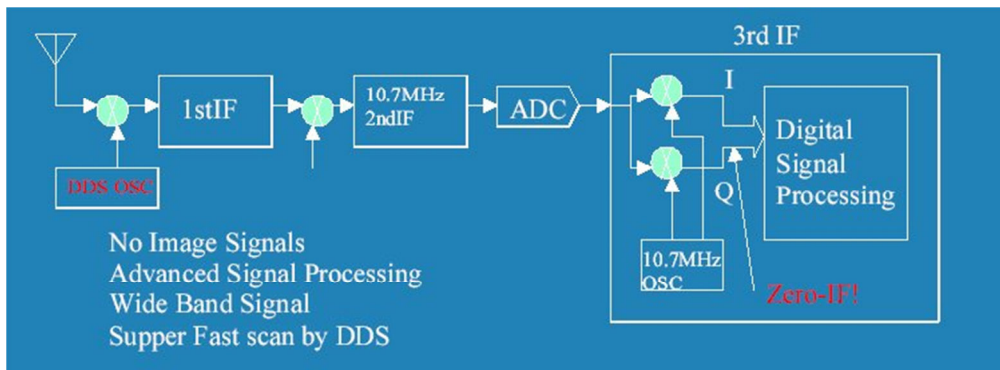

The output of the ADC is digitally heterodyned to ZERO frequency to obtain an I/Q signal. Thereafter, the I/Q signal is being filtered to limit the bandwidth and further down sampling for DSP processing.

The USB2.0 is running at a top speed of approx. 100Mbps in isochroous mode in order to obtain a wide bandwidth.

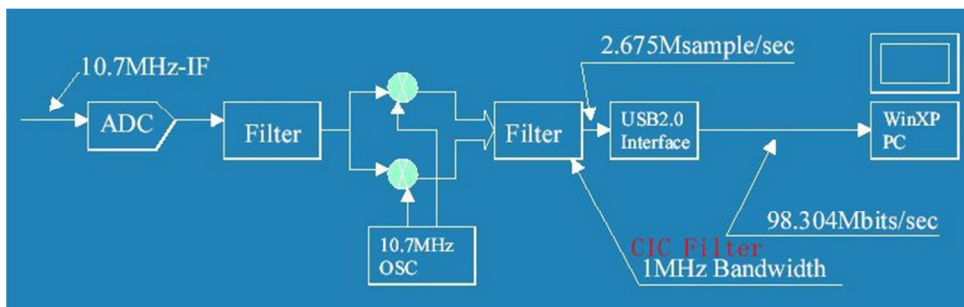

The I/Q output utilizes a CIC filter to simplify the circuit. The high frequency of the I/Q output signal may contain aliasing noise, therefore a 500KHz low-pass filter is needed on the PC side.

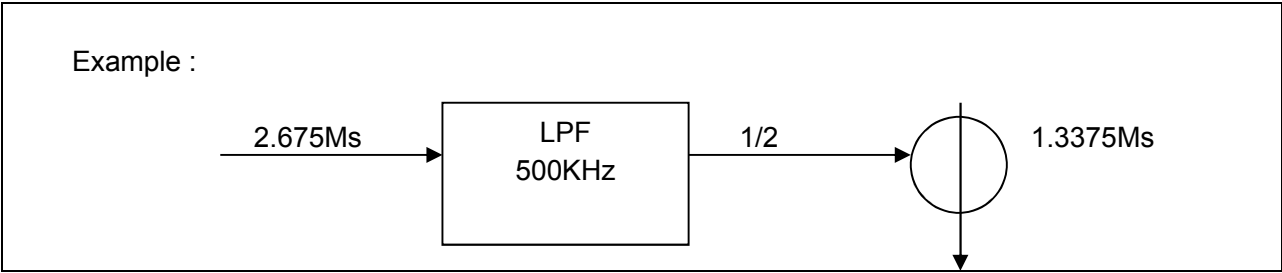

3. DATA FORMAT

- 1) **Sampling Rate:** 2.675Msample/Sec
- 2) **USB:** 98.304Mbit/sec., Isochronous (USB2.0)

3) **Data Format:**
 Floating Point format
 $I = I\text{-Index} * 2^{\text{Exponent}}$
 $Q = Q\text{-Index} * 2^{\text{Exponent}}$

Example,
 When I-Index=0x123 Q-Index=0x345 Exponent=5
 then
 $I = 0x123 * 2^{-5}$ $Q = 0x345 * 2^{-5}$

Original Data

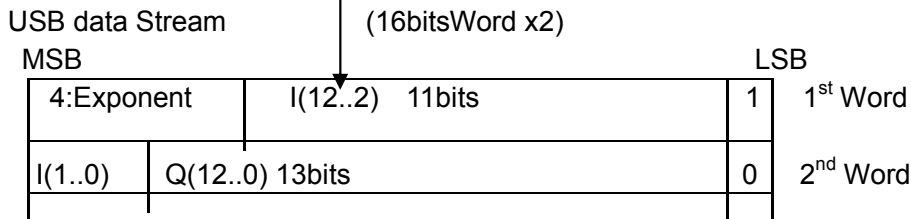
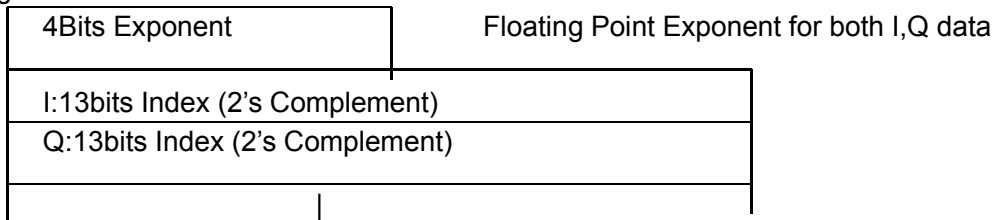

- 4) **USB Interface:** ENDPOINT 6
- 5) **USB driver for Windows XP**

● **USB DRIVER INSTALLATION**

To install the driver, the following files are required.

AORAlpha.sys AR-ALPHA USB Client Driver

It will be copied in the Windows directory system32\drivers"

AORAlpha.inf AR-ALPHA USB client driver inf file

AORAlphaDD.h IoControl type / Structure / Includes the files that defines GUID etc...

- **NOTE FOR PC SOFTWARE DESIGN**

To read the I/Q data, the client driver needs to be interfaced for data acquisition.

The data acquisition is easily accomplished by a simple setup. The test program “AR-ALPHA TestAPP”, written by C++ is supplied. (Sample code is supplied with driver software.)

5.1 Get the device path

The supplied client driver needs to obtain the device using **SetupDiXXX()** API functions before opening driver by **CreateFile()** API. This is because the driver interface uses GUID for the application.

Following is an example to get the device.

(a) OPEN DEVICE SET

Obtain device information by **SetupDiGetClassDevs()** API

(b) LIST AVAILABLE DEVICES

Call **SetupDiEnumInterfaceDevice()** API with loop.

(c) GET DEVICE PATH

detailData (Device Information of Structurer) ->devicePath (Set member)

(d) OPENNING DEVICE THAT HAS ACQUIRED

It can be opened by CreateFile() API

The GUID of the driver is defined under GUID_CLASS_ALPHA of the included file of AORAlphaDD.h

5.2 FUNCTIONS REFERENCE

The following table describes the functions and arguments in DeviceControl()API that are unique to the AR-ALPHA client driver. The structure and control code described here are defined in the AORAlphaDD.h.

NOTE: Receiving the Isochronous data is handled by ReadFile()API.

5.2.1 ALPHA_BULKOUT

CONTROL CODE	ALPHA_BULKOUT
PROPTO-TYPE	<pre> BOOL DeviceIoControl(HANDLE hDevice, // = DEVICE HANDLE DWORD dwIoControlCode, // = ALPHA_BULKOUT LPVOID lpInBuffer, // = PALPHA_BULKOUT_PRM DWORD nInBufferSize // = sizeof(ALPHA_BULKOUT_PRM)-1+DATA SIZE LPVOID lpOutBuffer, // = NULL DWORD nOutBufferSize, // = 0 LPDWORD lpBytesReturned, // = POINTER LPOVERLAPPED lpOverlapped // = Overlapped POINTER); </pre>
FUNCTION	OUTPUT TO THE END-POINT OF BULK-OUT OF AR-ALPHA
STRUCTURE	<pre> typedef struct _ALPHA_BULKOUT_PRM { UCHAR ucEndPoint; // OUTPUT END^POINT ULONG ulSize; // OUTPUT DATA SIZE (BYTE) UCHAR ucaData[1]; // OUTPUT DATA POINTER } ALPHA_BULKOUT_PRM, *PALPHA_BULKOUT_PRM; </pre>
NOTE	Include header : AORAlphaDD.h

5.2.2 ALPHA_BULKIN

CONTROL CODE	ALPHA_BULKIN
PROPTO-TYPE	<pre> BOOL DeviceIoControl(HANDLE hDevice, // = DEVICE HANDLE DWORD dwIoControlCode, // = ALPHA_BULKIN LPVOID lpInBuffer, // = PALPHA_BULKIN_PRM DWORD nInBufferSize, // = sizeof(ALPHA_BULKIN_PRM) LPVOID lpOutBuffer, // = POINTER FOR INPUT BUFFER DWORD nOutBufferSize, // = INPUT BUFFER SIZE (BYTE) WORD lpBytesReturned, // = POINTER FOR VARIABLES TO RECEIVE TRANSFER BYTE. LPOVERLAPPED lpOverlapped // = Overlapped POINTER); </pre>
FUNCTION	Input data from the end-point of the BULK-IN for AR-ALPHA
STRUCTURER	<pre> typedef struct _ALPHA_BULKIN_PRM { UCHAR ucEndPoint; // INPUT END-POINT ULONG ulSize; // INPUT DATA SIZE (BYTE) </pre>

	} ALPHA_BULKIN_PRM, *PALPHA_BULKIN_PRM;
REMARK	AORAlphaDD.h (INCLUDE HEDAER)

5.2.3 ALPHA_START_CAPTURE

CONTROL CODE	ALPHA_START_CAPTURE
PROTO-TYPE	<pre> BOOL DeviceIoControl(HANDLE hDevice, // = DEVICE HANDLE DWORD dwIoControlCode, // = ALPHA_START_CAPTURE LPVOID lpInBuffer, // = PALPHA_CAPTURE_PRM DWORD nInBufferSize, // = sizeof(ALPHA_CAPTURE_PRM) LPVOID lpOutBuffer, // = NULL DWORD nOutBufferSize, // =0 LPDWORD lpBytesReturned, // = POINTER FOR VARIABLES TO RECEIVE TRANSFER BYTE. LPOVERLAPPED lpOverlapped // = Overlapped POINTER); </pre>
FUNCTION	Start data acquisition from the end-point of ISOCRONOUS-IN of the AR-ALPHA.
STRUCTURER	<pre> typedef struct _ALPHA_CAPTURE_PRM { UCHAR ucIsoInEndPoint; // DATA END POINT } ALPHA_CAPTURE_PRM, *PALPHA_CAPTURE_PRM; </pre>
NOTE	INCL. HEADER AORAlphaDD.h

5.2.4 ALPHA_STOP_CAPTURE

CONTROL CODE	ALPHA_STOP_CAPTURE
PROTO-TYPE	<pre> BOOL DeviceIoControl(HANDLE hDevice, // = DEVICE HANDLE DWORD dwIoControlCode, // = ALPHA_STOP_CAPTURE LPVOID lpInBuffer, // = PALPHA_CAPTURE_PRM DWORD nInBufferSize, // = sizeof(ALPHA_CAPTURE_PRM) LPVOID lpOutBuffer, // = NULL DWORD nOutBufferSize, // =0 LPDWORD lpBytesReturned, // = POINTER FOR VARIABLES TO RECEIVE TRANSFER BYTE. LPOVERLAPPED lpOverlapped // = Overlapped POINTER); </pre>
FUNCTION	Start data acquisition from the end-point of ISOCRONOUS-IN of the AR-ALPHA.

STRUCTURER	typedef struct _ALPHA_CAPTURE_PRM { UCHAR uclsoInEndPoint; // DATA END-POINT } ALPHA_CAPTURE_PRM, *PALPHA_CAPTURE_PRM;
REMARK	INCLUDE HEADER AORAlphaDD.h

APPLICATION NOTE

CALLING PROCEDURE

Typical driver calling procedure is as follows:

- Opening DRIVER Get the device handle through CreatFile API.
- Starting isochronous reception DeviceIoControl API(ALPHA_START_CAPTURE)
- Capturer Start Send DeviceIoControl API(ALPHA_BULKOUT)
- Acquiring Captured Data Call ReadFile API to acquire captured data
- Capturer End Send DeviceIoControl API(ALPHA_BULKOUT)
- Ending isochronous reception DeviceIoControl API(ALPHA_STOP_CAPTURE)
- Closing Device CloseHandle() API to close device

NOTE:; Set size above 512x3x1024 to read with ReadFile()
 Size is defined as kMinReadSize in AORAlphaDD.h

REGISTRY INFORMATION

The registry information for the driver is as follows:

NOTE: Initial values are described in INI file.

REGISTRY PATH:

:HKEY_LOCAL_MACHINE\SYSTEM\CurrentControlSet\Services\ALPHA

Value Type	Default (hex)	DESCRIPTION
	Range (hex)	
Type	1	Service type is a kernel driver.

	Fixed Value	
Start	3	This driver will be loaded at the time of PnP.
	Fixed Value	
ErrorControl	1	Error message will be generated when driver encounter the error.
	Fixed Value	
Group	Extended Base	""Extended Base"" is a group to load at the time of boot.
	Fixed Value	
DebugInfo	101	Debugging control flag for kernel debugger.
	0~ffffff	

12. RESET

Should the AR-ALPHA appear to behave strangely, normal operation may be easily regained by resetting the microprocessor.

Before applying one of the three different levels of reset (RESET, RESET 2, RESET F), first try to turn off the power switch on the front panel. Leave it off for approximately 30 seconds. Turn the power switch back on again.

Normal operation should be restored but the last used frequency will be lost, the AR-ALPHA will display the second-last frequency used.

Should AR-ALPHA still behave strangely, try one of the following reset levels:

A) **RESET**

This initializes all parameters in the CONFIGURATION menu panel to factory default.

Turn of the power switch on the front panel. Hold the [3] key and [6] key while powering up AR-ALPHA. On the left side of the boot up screen you should briefly see "RESET".

B) **RESET 2**

This initializes everything except for the memory channels.

Turn of the power switch on the front panel. Hold the [3] key, the [6] key and the [9] key while powering up AR-ALPHA.

On the left side of the boot up screen you should briefly see "RESET 2".

C) **RESET F**

This initializes everything, all the settings and memories you saved will be ERASED.

Turn of the power switch on the front panel. Hold the [3] key, the [6] key, the [9] key and the [MONI] key while powering up AR-ALPHA.

On the left side of the boot up screen you should briefly see "RESET F".

13. FIRMWARE UPGRADE

FIRMWARE VERSION CHECK

From the main key pad, access the configuration screen by pushing the [FUNC] and [7] keys.

The configuration screen should look like this.

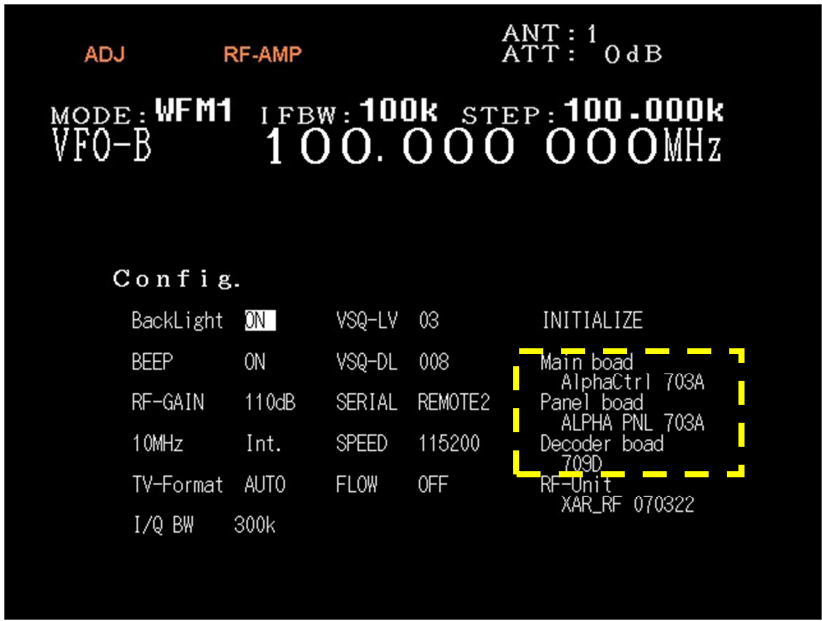

The dotted area displays the firmware versions for the main (control) board, panel board and the decoder board that can be updated by PC. (The versions displayed above might be outdated)
If a firmware newer than the version in your AR-ALPHA is available, proceed as described below.

SOFTWARE & HARDWARE REQUIRMENTS

- AOR's original software "SHBOOT".
- PC running Windows 2000 or XP SP2 or later, with a vacant serial communication port (COM port).
- Serial cable (female-female)
- 2 boot files and 3 firmware files supplied by AOR

Please inquire AOR's head-office in Japan at mail@orja.com for the latest available firmware corresponding to your hardware version. (Check the serial number at the back of the receiver)
Do not perform an update if the firmware version is already the newest available.

HOW TO ACCESS

Power OFF AR-Alpha.
Remove the 11 screws from the bottom cover to access the AR-ALPHA circuit. The photograph shows the AR-ALPHA bottom cover removed.

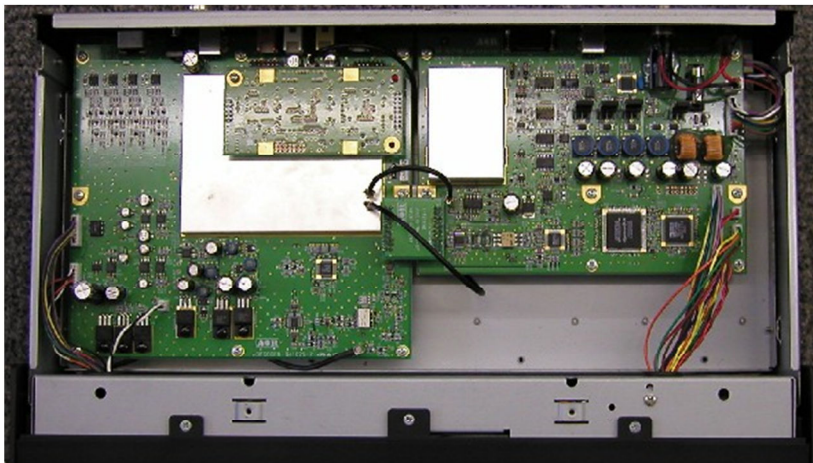

DIP SWITCHES AND JUMPERS

To update the firmware, the jumpers and DIP switches need to be repositioned. The photograph and illustration show the location of the jumpers and DIP switches, and their default (factory setting) position.

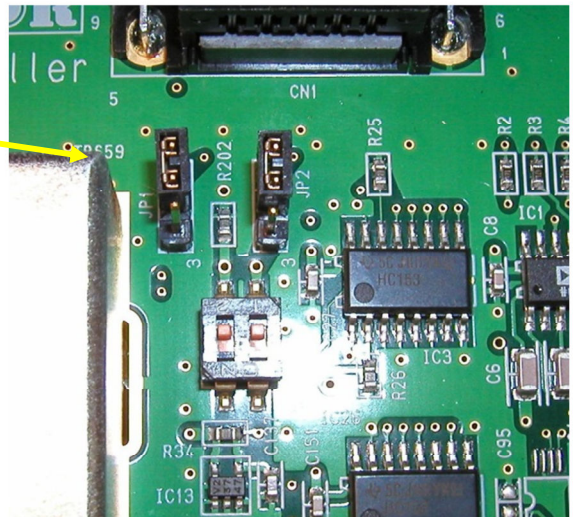
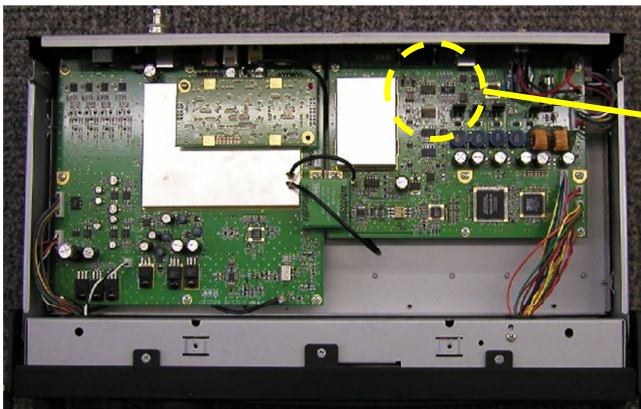

DEFAULT JUMPERS & DIP SWITCHES POSITION

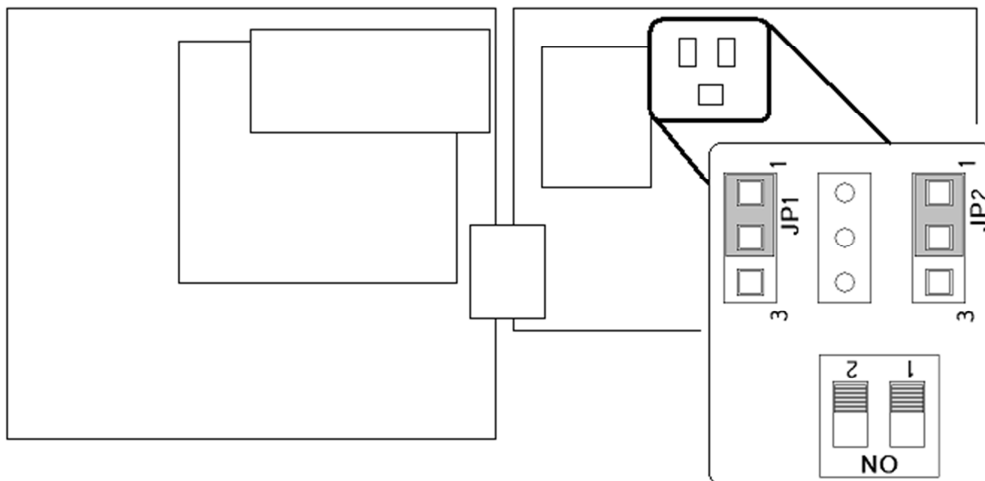

LOADING DATA

Start the flash writer program (SHBoot) by double clicking the SHboot icon. The following screen should be seen.

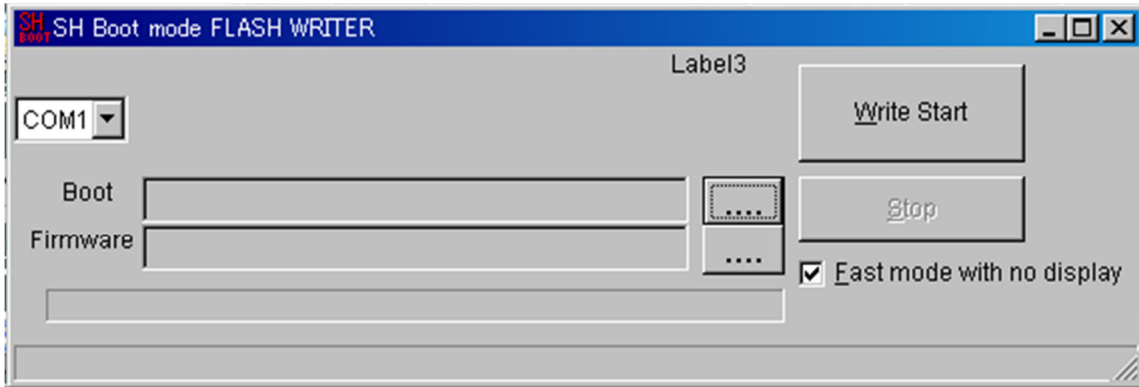

Each block must be updated one at a time.

Do not perform an update if the firmware version is already the newest available.

Proceed in the following order:

- ① Set the jumpers and dip switches properly
- ② Power on AR-ALPHA (see CAUTION remarks at the bottom of the page)
- ③ Load the BOOT file
- ④ Load the FIRMWARE
- ⑤ Click on WRITE START
- ⑥ Power OFF AR-Alpha and start again from STEP 1 if you need to update another block.

To load the data, click the button  to choose the appropriate data file as summarized in the following table.

When all updates are done, do not forget to set the jumpers and dip switches into their DEFAULT position.

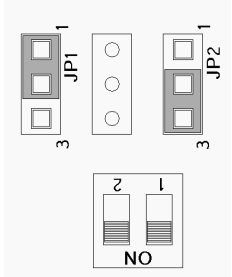

UPDATE BLOCK	DATA FILE NAME		JUMPER & DIP SWITCH
	Boot	Firmware	
PANEL BOARD	boot-ARA-PANEL.mot	ARA-PANEL_080620v806B.mot	

DECODER BOARD	boot-ARA-Controller.mot	ARA-decoder806b.mot	
MAIN (control) BOARD	boot-ARA-Controller.mot	ARA-ctrl_080620v806Aa.mot	

CAUTION

WHEN UPDATING THE PANEL BOARD AND DECODER BOARD, BE SURE TO TURN ON BOTH MAIN SWITCH (ON THE BACK) AND FRONT PANEL POWER SWITCH BEFORE LOADING THE FILES.

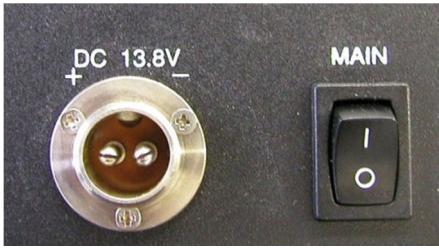
FOR MAIN BOARD, ONLY THE MAIN SWITCH (ON THE BACK) NEEDS TO BE ON.

UPDATE TYPE		
MAIN BOARD	ON WHILE LOADING	N/A
PANEL	ON WHILE LOADING	ON WHILE LOADING
DECODER	ON WHILE LOADING	ON WHILE LOADING

14.OPTIONAL ACCESSORIES

AS5001 Antenna selector



PSU-ALPHA AC adapter 100-240V



ANTENNAS

AOR ANTENNA RANGE

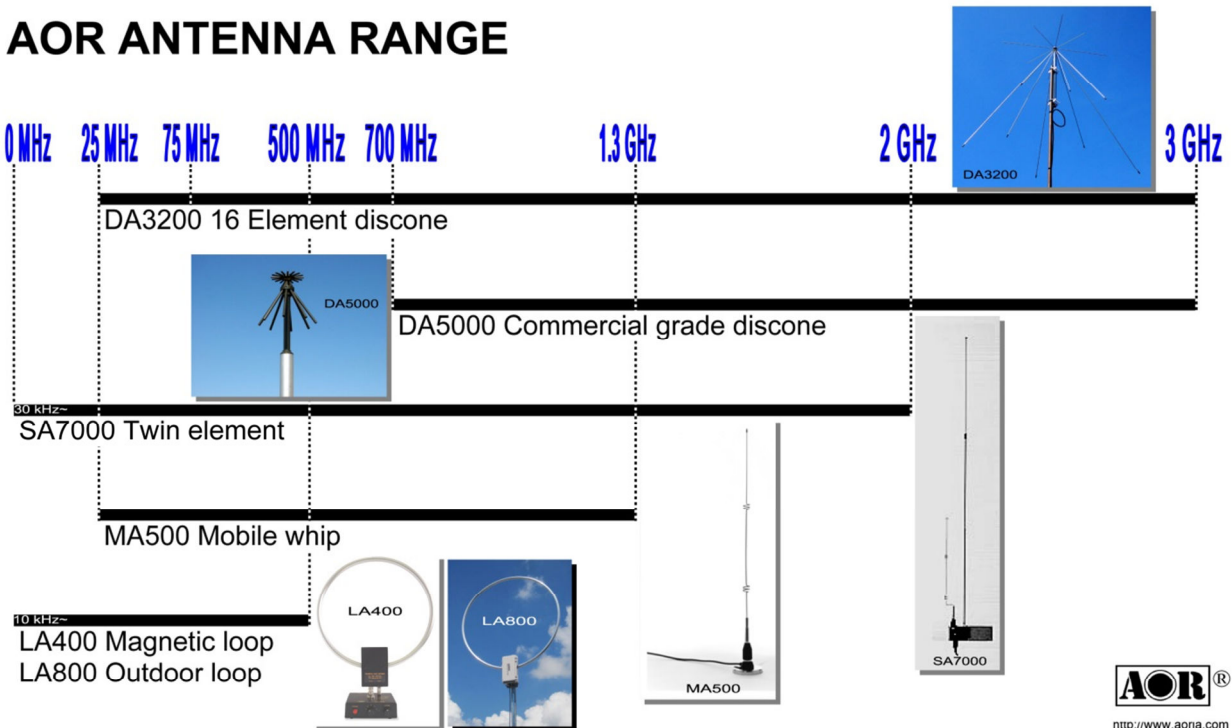

BNC connectors for MA500 and LA400/800. N connectors for DA3200, DA5000, SA7000 (SA7000 also includes BNC-N and BNC-PL259 adapters)



<http://www.aorja.com>

(March 1, 2013)

15. LIMITED WARRANTY (USA only)

AOR USA, Inc. (AOR) warrants the AR - ALPHA as described below:

AOR will repair or exchange equipment as a result of defects in parts or workmanship for a period of one year from the date of original retail purchase from an authorized AOR dealer.

Exclusions

The following items are not covered by the AOR limited warranty:

1. Products that are damaged through accident, abuse, misuse, neglect, or user modifications.
2. Problems that arise through failure to follow directions in the owner's manual.
3. Exposure of the product to adverse or severe weather conditions, including lightning, temperature extremes or water, including rainfall or immersion.
4. Exposure to toxic materials, biohazards, radioactive materials or other contamination.
5. Repairs attempted by parties other than AOR or its authorized personnel.
6. Damage that results from improper installation, including improper voltage and/or reversed polarity, or exposure of a receiver to signal levels exceeding specifications.
7. Damage resulting through the use of accessories from manufacturers other than AOR.
8. Equipment that has had serial numbers removed or altered in any way.
9. Damage that occurred as a result of shipment. Claims must be presented to the carrier.
10. AOR is not responsible for any costs arising from installation or reinstallation of the equipment, nor for any consequential (such as loss of use) damage claims.

Obtaining Warranty Service

1. You are responsible for shipping the product to AOR and any related costs.
2. Warranty claim must be accompanied by a legible copy of the original product purchase receipt.
3. You must include a description of the problem(s) encountered with the product.
4. You must include your name, a valid ground shipping address (including zip code) and telephone contact information.
5. AOR will ship the repaired (or replaced) product by ground transport.

Limitations

Any and all implied warranties, including those pertaining to merchantability and utility for a specific purpose are limited to the duration of this limited warranty.

AOR's limits on warranty pertain only to the repair or, at its option, replacement of defective products. AOR shall not be liable for any other damages, including consequential, incidental or otherwise, arising from any defect.

Some states do not allow limitations on how long an implied warranty lasts and may not allow the exclusion of incidental or consequential damages. As such, the above limitations may not apply in every case. This warranty gives you specific legal rights and you may have other rights that apply in your state.

If you have questions about this limited warranty, or the operation of your AOR product, contact AOR at

(310) 787-8615 during normal business hours (9 am ~ 5 pm Pacific Time Zone), or write to AOR, 20655 S. Western Ave., Suite 112, Torrance, CA 90501. You may also send a fax to AOR at (310) 787-8619. Additional information is available at the AOR web site: www.aorusa.com

We suggest attaching your purchase receipt to this half of the warranty card and that you keep this information in a secure location.

AOR Model Number _____

Serial Number _____

Dealer Name _____

Purchase Date _____

16. CONTROL SOFTWARE

AR-IQ

Receiver Control, I/Q Record & Playback for AR-ALPHA



Introduction

AR-IQ software allows direct control of the AR-Alpha receiver through a graphical interface. The recorded samples are acquired through the USB I/Q Port and further processed (filtered and demodulated) by the PC CPU. All commands are sent to the AR-Alpha through the receiver's remote control USB port.

AF vs. I/Q

Compared to a regular AF recording, which only allows recording one frequency at a time, I/Q recording allows you to store and playback a full 1MHz bandwidth with no loss of quality!

This 1MHz bandwidth can be anywhere within the receiving range of the AR-ALPHA, between 10kHz and 3.5GHz.

Off-line, you can listen and decode within the recorded 1MHz range, tuning any frequency as you would in real time. You can even loop a particular time frame to listen repeatedly to a signal received in difficult conditions, or search for and analyze hard to catch signals bursts.

I/Q on the move...

It is also possible to move the I/Q data to another PC and to listen/decode it off line, as long as the other PC has the AR-IQ software installed as well (see software registration chapter 5). Although AR-IQ data can be copied to any data storage device (USB key, DVD, external hard-drive, etc...), the data must be first copied to the hard drive of the other PC for AR-IQ software to work properly. It will not work if the I/Q data is read from a DVD, USB key or through a network, since the read speeds would be too slow.

16.1 Minimum system requirements

- 2.5 GHz Dual Core CPU with 1GB RAM
- Two available USB 2.0 High-Speed (480Mbit/s) ports. (Three ports if the USB-key license system is used)
- 16 bit AC-97 compatible audio board
- 1024 x768 minimum resolution video board and monitor
- 2 button wheel mouse
- 10 GB or more internal hard-disk
- Supported OS: Windows 2000 SP4, Windows XP SP2, Windows Vista, Windows 7&8

Note: The above specifications are for reference only and might vary depending on your PC system.

16.2 USB driver installation

- ◆ All following screenshots were made using Windows XP. Messages appearing on screen may differ slightly depending on which version of the Windows operating system and which driver version is used.

- ① Connect a USB cable to the **REMOTE 1** socket on the rear panel of AR-Alpha, and to a spare USB socket on the PC. (Cable type “USB-A to USB-B”)

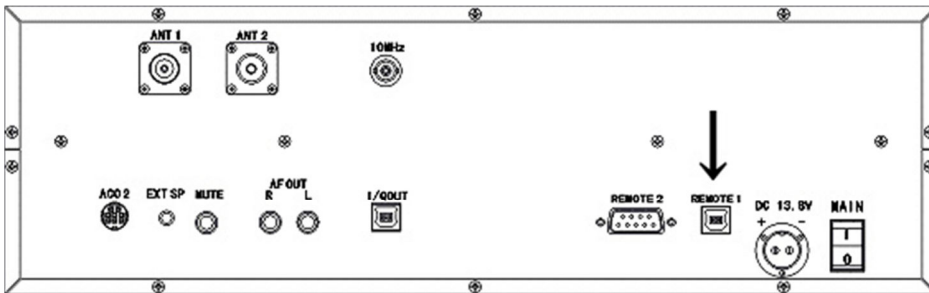

- ② Switch AR-Alpha on.

MAKE SURE THAT IN THE RECEIVER'S CONFIGURATION MENU, YOU HAVE “REMOTE 1” SELECTED FOR “SERIAL”, OTHERWISE THE USB CONNECTION WILL FAIL.

Windows detects the new hardware and begins the driver installation procedure.

- ③ Windows is asking to connect to Windows Update to search for software.

Select “NO, NOT THIS TIME” and click “Next”.



- ④ By default, Windows will select “Install the software automatically”, but you need to select “Install from a list or specific location” instead.

Then click next.

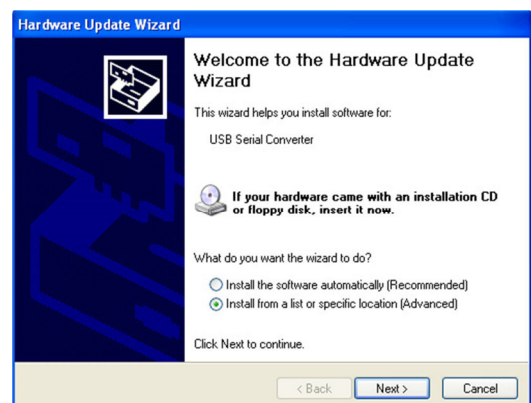

- ⑤ Locate the folder containing the USB driver by clicking on “Browse”, to find the driver location.

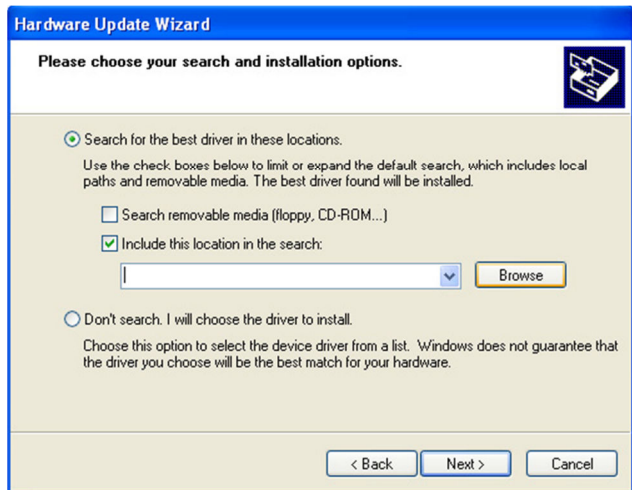

- ⑥ If you are loading the driver files from the CD supplied with the AR-ALPHA, proceed as shown by selecting the “USB driver” folder inside the CD.

Validate your selection with “OK”

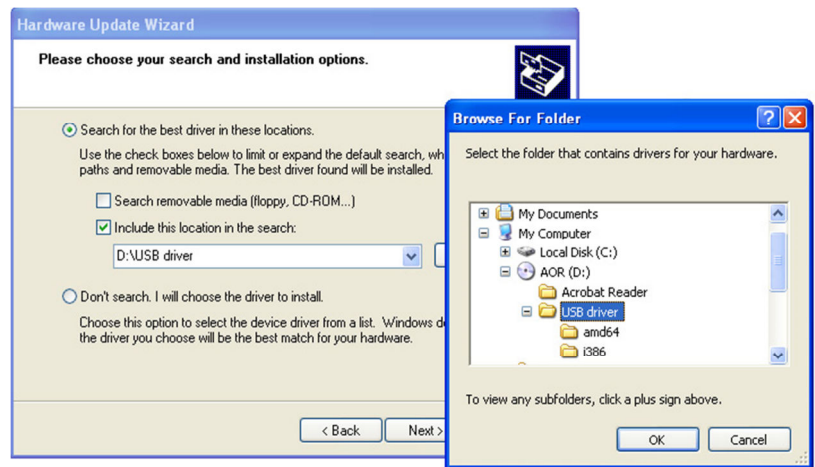

Note: A newer USB driver might be available at <http://www.ftdichip.com/ftdrivers.htm> Click “VCP Drivers”: then select the device number “FT232B”. Download the zip file and unzip it to the folder of your choice. This is then the folder you have to locate in the hardware update wizard.

- ⑦ Windows informs the user about the status of the Windows Logo testing of this USB driver.

Click “Continue Anyway” and allow the driver installation to set up automatically.



⑧ Click “Finish”.

The USB driver is now installed.



16.3 I/Q driver installation

- ◆ All following screenshots were made using Windows XP. Messages appearing on screen may differ slightly depending on which version of the Windows operating system and which driver version is used

- ① Connect the other USB cable to the I/Q OUT socket on the rear panel of AR-Alpha, and to a spare USB socket of the PC. (Cable type “USB-A to USB-B”)

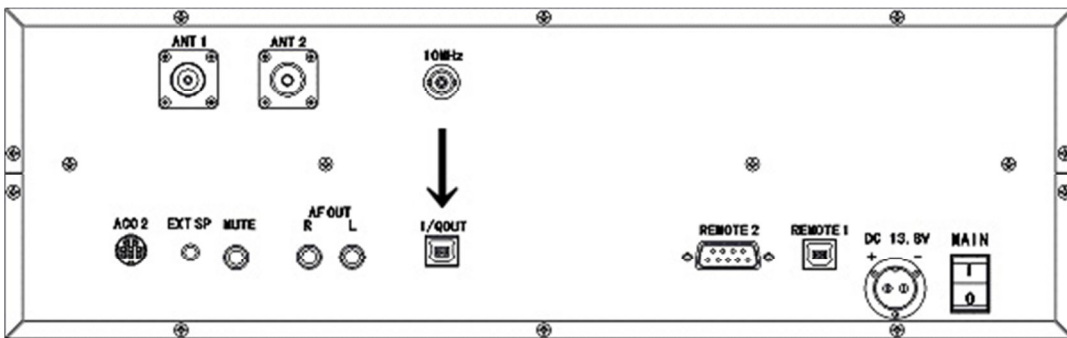

- ② Make sure AR-Alpha is switched ON. Windows detects the new hardware and begins the driver installation procedure.

Windows is asking to connect to Windows Update to search for software.

Select “NO, NOT THIS TIME” and click “Next”.



- ③ By default, Windows will select “Install the software automatically”, but you need to select “Install from a list or specific location” instead.

Click next.



- ④ Locate the folder containing the I/Q driver by clicking on “Browse”, to find the driver location.

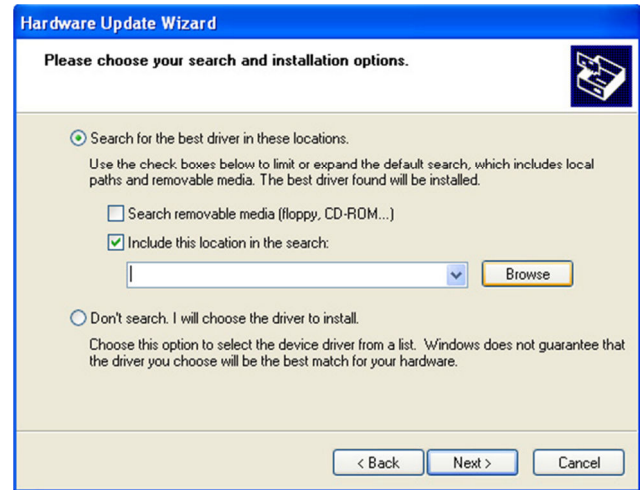

- ⑤ If you are loading the driver files from the CD supplied with the AR-ALPHA, proceed as shown by selecting the “IQ driver” folder inside the CD.

Validate your selection with “OK”

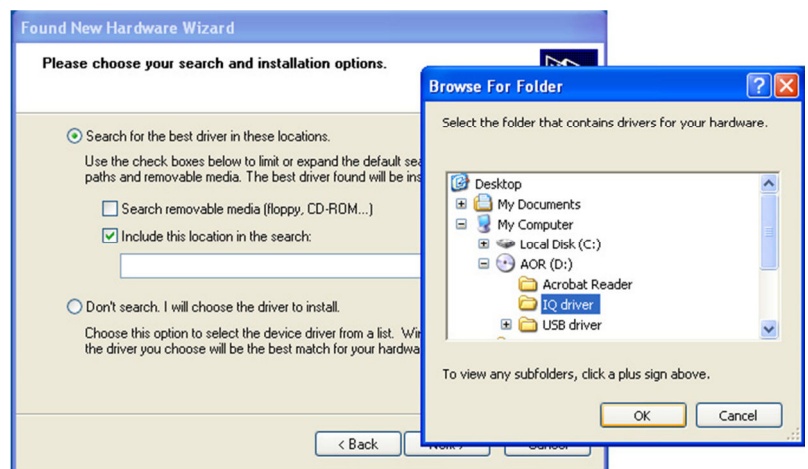

- ⑥ Click “Finish”.

The I/Q driver is now installed.

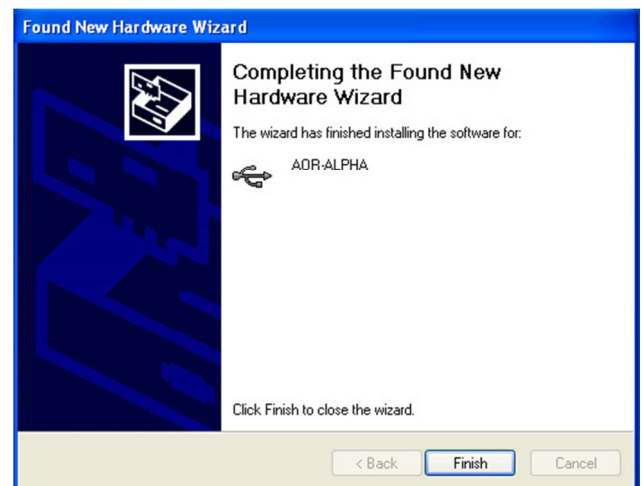

16.4 Software Installation

- ① Copy the folder “AR-IQ software v.X” (“X” being the version number) from the supplied CD to any location in your hard drive
- ② When first run, the software will ask you about the COM port to which the AR-Alpha USB Remote Control is connected. After the first run, local settings will be saved in the windows registry.

Possible error message, if the COM port number you entered is incorrect

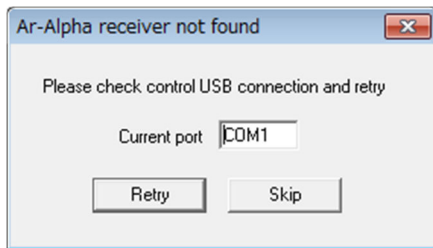

Solution: In order to find out which COM port number Windows has assigned, check the **Device Manager's "Ports (COM&LPT)"**.

USB Serial port (COM x) will be indicated. (Note: “x” varies depending on your PC configuration.)

The example screenshot here shows that COM8 has been assigned for the COM port.

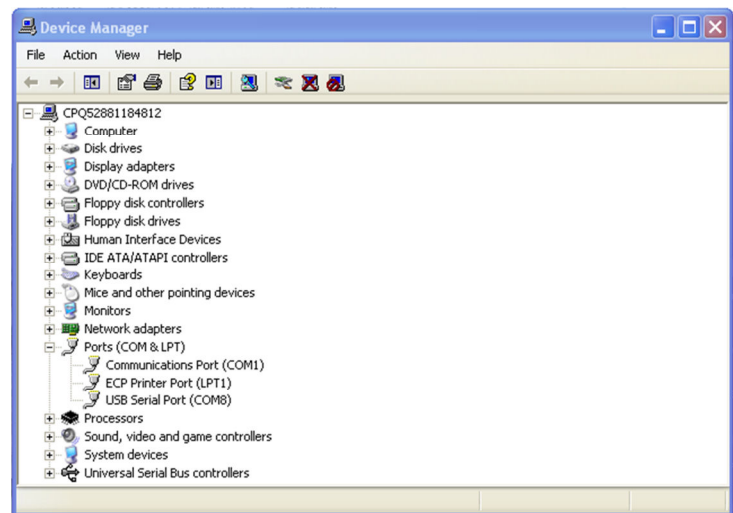

- ③ To start the software, double click the file “ar-iq.exe” located inside the folder “AR-IQ software v.X”

Registry keys not GUI editable (advanced users only)

(*HKCU\Software\Microtelecom s.r.l.\ar-iq\v1.0*)

- *AGCRiseTime_ms* Controls the response of the spike rejection filter (min=5, max=100, default=25).
- *AudioLatency* Controls the audio buffer length; lower values minimize latency, higher values are required for slower computers (min=4, max=20, default=9).
- *AutoModeCountry* Sets the region for automatic mode change (based on tuned frequency). Accepted values are 0 for USA, 1 for Japan or 2 for Europe.
- *LevelBarPos* Controls the level bar position (0=left, 1=center, 2=right).
- *MouseWheelReverse* If set to 1, inverts the mouse wheel rotation effect. Accepted values are 0, 1.
- *PowerOffOnExit* If set to 1, shuts down the receiver when the program is exited. Accepted values are 0, 1.
- *VcomPort* Sets the virtual COM port for CI-V operation (1..255).

16.5 Software registration

① Using the software on a single PC

The software is free for unlimited use on a SINGLE PC, nevertheless you need to register after 30 days of use. The registration is free as long as the software is installed only once on a single PC. The license issued as explained below, is locked to your PC's hardware ID. For this reason the software can only be used on the PC on which it has been registered to.

Your PC's hardware ID will change if you replace a major component such as motherboard, CPU, hard disk, etc... This ID change will prevent the software to recognize the PC it has been registered to and thus the software will fail to launch. Please contact us for assistance if you face this situation.

If you intend to use this software on multiple PCs, see details on the next page.

To show the registration form, click on the blue icon in the top left corner of the application

This window will pop-up.

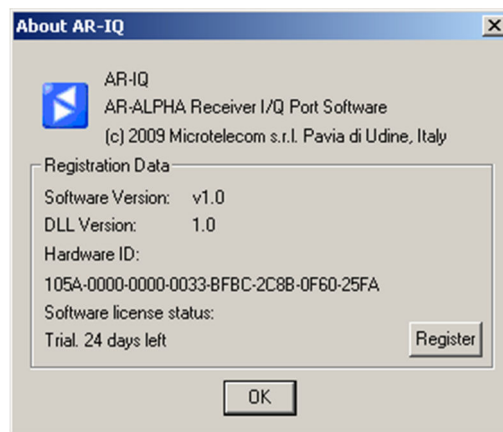

Click the "Register" button.

All fields should be filled with the requested data. Clicking on the "REQUEST LICENCE" button, an e-mail will be sent for the license generation process. Users will receive the license file in the supplied mailbox [within a few days](#). If no Internet connection is available, the "SAVE REQUEST TO FILE" button should be used, thus creating a text file (regdata.txt) that must be manually sent via email to the dealer for the activation process. After receiving a confirmation email, save the mail attachment in the same folder where the AR-IQ software is located.

In order to use this software beyond the trial period you need a valid license file.

To obtain the license file for this PC, please fill the following form with your name, your company name (if applicable) and your e-mail address.

If this PC has an internet connection click the button "Request License". This will open your default web browser and transmit the request to your dealer.

If this PC has no internet connection, click the button "Save Request to File". This will save your registration data to the file regdata.txt in the folder where you have installed this software. You will need to copy this file and send it to your dealer by email.

Once your order will be processed, you will receive the license file at your E-mail address. Copy this file in the folder where you have installed the software. This will complete the registration process.

First Name	<input type="text" value="John"/>
Last Name	<input type="text" value="Wayne"/>
Company	<input type="text" value="ACME Inc."/>
E-mail Address	<input type="text" value="john.wayne@farw.est"/>
Hardware ID	<input type="text" value="105A-0000-0000-0033-8FBC-2C8B-0F60-25FA"/>

If the registration procedure is completed correctly, the “About” dialog window should look like this.



② **Using the software on multiple PCs**



A USB-key based license system is available as an option through your local AOR dealer.

- Note:
- One USB 2.0 socket is required to use the USB-key license system, as it needs to be inserted every time the software is used.
 - This USB-key is unique and cannot be reproduced.
 - The license information data inside the USB-key is hidden on purpose and cannot be backed-up. If you lose or damage the USB-key, a new USB-key needs to be purchased.
 - Do not use this USB-key for any other purpose such as data storage. Formatting the USB-key, overwriting or deleting its content will destroy the licensing system, and another USB-key would have to be purchased.

■ Using the USB license-key for the first time:

- ① Insert the USB-key in an available USB socket of your PC. Windows will automatically install a driver, recognize it as a common USB flash drive named AR-IQ and assign a drive letter such as “D:”, “E:” etc...
- ② Inside the USB-key, locate the folder “ar-iq v.X” (“X” being the software version). The software’s executable “ar-iq.exe” is located inside this folder. The software can either be run directly from the USB-key, or from any location on your PC hard drive, providing the folder “ar-iq v.X” has been copied to that location.
(Depending on your PC’s specifications, the software might not run smoothly if run directly from the USB key.)
- ③ Double click “ar-iq.exe” to start the program.
Refer to the following chapter 6 for details on how to operate the software.

Do never record I/Q data directly to the USB-key! Chose a location on your hard drive instead.

16.6 Software functions

ATT (1)
Input signal attenuation. 0dB, 1.0dB, 20dB or Auto.

AMPLITUDE (5)
A amplitude adjustment. Main spectrum reference level and scale settings.

FREQUENCY (6)
Receiver frequency setting. Allows tuning using mouse wheel while hovering on digits. Double click to show frequency input dialog.

Span/RBW (9)
Span/resolution setting. Adjusts the main spectrum window bandwidth and resolution.

CF Step
Center frequency step. Sets the step used when clicking the left/right buttons (◀ ▶) under the main spectrum pane.

Wheel Step
Mouse wheel step setting. Sets the step used when spinning the mouse wheel.

IF FILTER (11)
Selects I/Q output bandwidth. Selecting "Center" the tuned frequency is always centered in the main spectrum view.

INPUT SELECT (13)
Selects the desired input source. Input can be either the receiver or a recorded file.

PLAYBACK/REC (14)
Controls file recording and playing. Buttons are Stop (square), Play (triangle) and Record (circle).

BW (15)
Controls maximum filter bandwidth shown in the secondary spectrum panel.

PBT, Notch, AMRej (15)
Allows selecting Passband Tuning (PBT), Notch and AM Rejection filters.

AVG (15)
Enables averaging of values shown in main and secondary spectrum windows.

NB Lev
Enables Noise Blanker. Slider position adjusts blanking level.

AGC (17)
Sets automatic gain control and its speed. SpkRej reduces spikes.

AM, SAM, CW, RTTY, LSB, USB, FM, WFM, DRM, USER (4)
Selects receiver demodulation type. DRM mode allows receiving digital transmissions (using third-party software).

Spect, Wfall, Zoom, Palette, NBW, NBN, AFC, Mono, Labels, PeakSrc, Auto (3)
Controls main spectrum/waterfall view; zoom and drawing mode and labels. NBW and NBN are noise blankers; AFC is automatic frequency control (FM only); Auto enables automatic mode selection.

FRONT-END (2)
Front-end control. Enables Preamp, allows Antenna selection.

AMPLITUDE (5)
Modifies reference level.

Waterfall control (7)
These sliders, enabled only in waterfall mode, allow to adjust speed, brightness and contrast.

FFT Resolution (9)
Allows choosing FFT sharpness/update rate.

AF, NR (10)
AF Vol allows changing the output volume; NR controls the noise reduction amount.

S-MTR (12 - pg.2)
Shows received signal power in RMS or Peak mode.

MKR (17)
Markers control. Clr clears all markers, Delta enables relative measurements.

Attenuators (1)

Attenuators allow you to attenuate the input signal by a preferred amount. Users can choose among 0, 10 and 20 dBm attenuation. The “Auto” button enables automatic attenuation, based on the current input signal level.

Front-End (2)

In the front-end sections, users can control antenna input and select preamp operation. Preamplifier is on when the button is lit. “Ant.1” and “Ant.2” buttons allow selecting the desired antenna input. If the optional AS5001 antenna switch is present, it's possible to select antenna input 3 or 4 clicking on the “Ant.Ex” button. The currently used antenna button will be lit.

Main spectrum window controls (3)

Under the main spectrum window, there are 10 buttons that allow user customization of the software. “Spect” button shows line spectrum view, while “Wfall” enables waterfall view. Users can reverse waterfall direction by clicking again on the “Wfall” button. While in waterfall mode, the “Palette” button will be selectable and clicking on it will pop-up a new window that allows palette selection among 9 predefined palettes.

“NBW” and “NBN” buttons control noise-blanking filters and operate at different stages. “NBW” enables a wideband noise blanker working on the full bandwidth range, before demodulation and any other signal processing; “NBN” enables narrow band filtering.

“Afc” enables automatic frequency control (tuning); if enabled, the demodulator will tune the frequency automatically, trying to track small frequency changes in the source signal. This operation mode is only available in FM mode.

“Mono” button is only selectable in WFM mode and forces single-channel audio decoding even if a stereo carrier is detected.

If “Labels” is selected and enabled, the main spectrum view will also show a dBm amplitude scale; moreover, a frequency and amplitude indicator will follow the mouse pointer while hovering on the main spectrum window in both spectrum and waterfall mode.

If “PeakSrc” is also selected, the indicators will snap to the highest peak close to the current mouse position. If “Auto” is enabled, the software will choose the preferred demodulator and filter settings, depending on the currently tuned frequency and area (Europe, Japan, USA).

Demodulation (4)

The software allows many demodulators, selectable by clicking on the desired button. “AM” selects amplitude modulation demodulator. Synchronous demodulation is also possible, by selecting the “SAM” button. “RTTY” and “CW” are self-explanatory; the demodulators will produce a tone when receiving signals. “LSB” and “USB” refer to lower and upper sidebands; these demodulators allow the decoding of AM signals with a suppressed sideband. “FM” and “WFM” demodulators will decode frequency-modulated signals, and in particular the “WFM” mode will allow 260 kHz wide filtering. “DRM” demodulator will output an 8 kHz IF DRM signal on a virtual audio cable (only if third-party software VAC is installed - <http://software.muzychenko.net/eng/vac.html>); for optimal DRM demodulation, it's best to set the AGC block to “Slow”. “USER” demodulation simply outputs on the VAC zero-IF I/Q samples, after filtering and normalization with current AGC settings.

Amplitude (5)

While in spectrum mode, users can select a preferred reference level and view scale, clicking on the arrows available on the right side of the “Ref Lev” and “Scale” indicators in the “AMPLITUDE” section.

Frequency and tuning (6)

This indicator always shows the current tuned frequency. If the operation mode is not set to “Center” (in the “IF FILTER” section), the AR-Alpha frequency can be different; frequency shift in this case is made by the software. The current frequency can be tuned using the mouse wheel while hovering with the pointer on the desired frequency digit. Double clicking on the frequency indicator, a dialog window will appear, allowing direct frequency input. Frequency can also be tuned dragging the main spectrum window (clicking with the left mouse button and moving the mouse left/right while on the main spectrum window).

	Main spectrum view	Secondary spectrum view	Frequency indicator
Mouse drag	If not in “Center” mode, the grey bar can be dragged on the waveform.	Fine tuning can be done dragging the waveform (a red vertical line shows current position).	No effect.
Double click	In “Center” mode, the receiver will tune to the requested frequency. Otherwise, software frequency shift will be used to tune the requested frequency.	The software will tune to the selected frequency.	The direct frequency input dialog will pop up.
Mouse wheel	Currently tuned frequency will be shifted upwards or downwards depending on wheel rotation direction and value set in the “Wheel Step” box.	Filter width (highlighted as a grey zone) will vary symmetrically.	Currently hovered frequency digit changes according to mouse wheel rotation.

Waterfall controls (7)

On the right side of the software window, there are three sliders that control waterfall appearance. From the top to bottom, the sliders control: waterfall speed, brightness and contrast. They can be operated by dragging the slider or using the mouse wheel while hovering over the controls.

Span (8)

It's possible to select the desired frequency span by clicking on the arrow buttons in the Span field. The smaller the span, the slower the main spectrum window will refresh.

FFT Resolution (9)

“Time”, “Mix” and “Freq” allow you to select the desired FFT characteristics, preferring update rate or FFT spectral resolution.

Volume control (10)

“AF Vol” controls output volume. Clicking on the button, the output can be muted; the slider controls volume output level. In “DRM” and “USER” mode there is no sound card output (all data is redirected to the Virtual Audio Cable).

IF Filter (11)

The “IF Filter” section allows selecting the AR-Alpha I/Q output bandwidth. The “Center” button forces the currently demodulated signal to be in the center of the main spectrum windows (and disables the software frequency conversion block). If not selected, all viewable frequencies are tunable without changing the AR-Alpha tuned frequency (through software frequency conversion).

S-Meter (12)

The S-Meter shows the current signal level and also provides the means to set squelch and auto mute functions. Squelch level can be enabled clicking the bar in the S1-S9 (green) zone with the left mouse button; any signal under the set value will not produce output. The Auto Mute level is set clicking in the S9 - S9+70 (red) zone; any signal higher than the limit will produce no output. Both functions can be disabled by right clicking on the limits symbols (triangles painted directly on the bars).

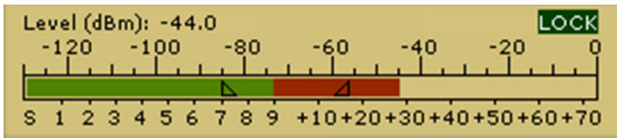

Input Select (13)

The input select section allows a choice of signal source. The “AR-Alpha” button selects real time processing; by choosing “Wav” and then “File” it’s possible to replay any previously recorded session.

Playback – record (14)

By using the “Playback/Record” section, it’s possible to control the recording and playback software features. The square button stops both playback and recording; the triangular button starts playback; the circular button starts recording, asking for path and filename before the actual start.

Note: When the USB-key license system is used and the program run directly from the USB key, be sure not to choose the USB key to store your recording data!

While playing a recorded file, a yellow progress indicator bar will fill up. Users can jump backward and forward in the recording by just clicking on the bar. It is also possible to repeat a segment, simply by highlighting it with the mouse (i.e. clicking on the beginning and holding the left mouse button down, moving the mouse pointer to the end of the desired segment and finally releasing the mouse button). The software will repeatedly decode the selected segment until another click on the bar is issued or the stop button is pressed.

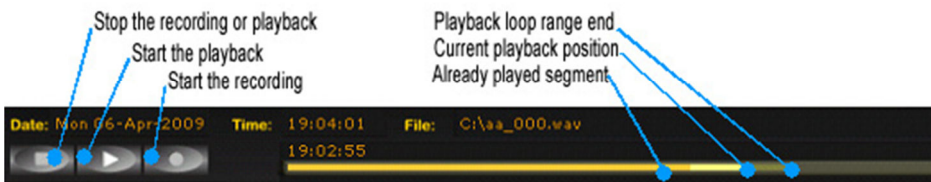

I/Q recording takes about 700MB of disk space per minute, which is 42GB per hour, or 1TB for 24 hours. Make sure you have plenty of disk space available depending of the desired length of the recording.

Secondary spectrum view (15)

In the secondary spectrum view, users can fine-tune the selected filter and enable Notch and AM Rejection filter.

Filters Bandwidth
There are 8 predefined bands. The 240 kHz filter is used in WFM demodulator mode only.

PBT
PassBand Tuning allows you to fine-tune the filter passband using the mouse wheel or dragging the filter edges (using the left mouse button). The right mouse button allows dragging both edges at the same time.

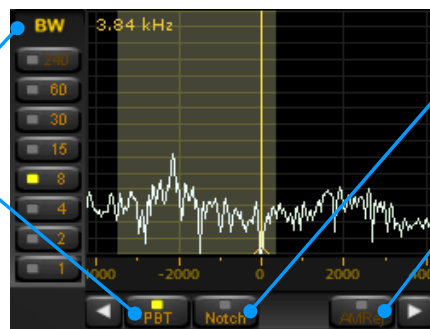

Notch Filter
If Notch is selected, double clicking on any frequency will enable the filter. Attenuation is tunable using the mouse wheel. Filter center can be dragged with the left mouse button.

AM Rejection
AM Rejection can be enabled by holding SHIFT and double clicking on the desired frequency in the secondary spectrum window. A red line will show the current setting. The filter can be disabled holding SHIFT while right clicking on the secondary spectrum window.

Averaging (16)

Main and secondary spectrum display averaging can be enabled by clicking on the button over the respective sliders. Slider positions set the number of averages used, the higher the slider position (and, as a consequence, the number of averages), the smoother the spectrum views.

AGC (17)

The automatic Gain Control block has 5 operational modes: "SpkRej" is spike rejection mode; "Fast", "Med" and "Slow" refer to the gain variation speed. By selecting "Off", the AGC processing block will be bypassed and the output level will be manually adjustable using the volume slider.

Markers (18)

The software allows placing 4 markers on the displayed frequency range. Markers can be set by right-clicking on any frequency in the main spectrum window; indicators will appear in the top right corner of the main spectrum view. "Clr" button removes all markers, while "Delta" button enables differential measures among markers, using the first one as reference.

Manufacturer: **AOR, LTD.**
2-6-4, Misuji, Taito-Ku,
Tokyo, 111-0055, Japan
URL: www.aorja.com
e-mail: mail@aorja.com

US distributor: **AOR USA, INC.**
20655 S. Western Ave. Suite 112
Torrance, CA 90501
Phone: 310-787-8615
Fax: 310-787-8619
URL: www.aorusa.com
e-mail: info@aorusa.com