

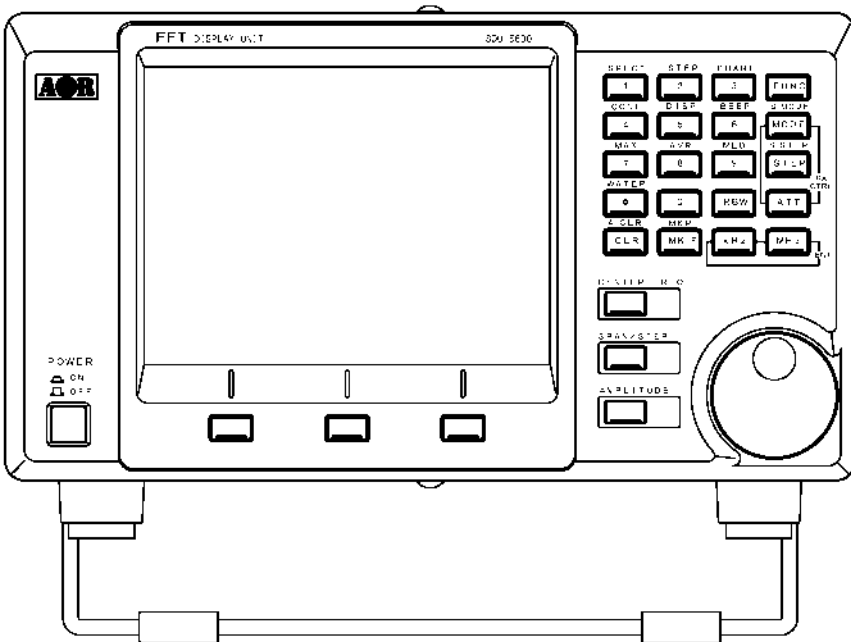

FFT spectrum display unit

SDU5600

PROFESSIONAL SPECTRUM
DISPLAY UNIT FOR USE WITH
A COMPANION RADIO



OPERATING MANUAL

Index

| | |
|---|-----------|
| Safety notices | 5 |
| SDU5600 brief circuit description | 6 |
| LCD resolution | 6 |
| Block diagram | 7 |
| Introduction | 8 |
| 1 Controls and Descriptions | 9 |
| 1.1 Front panel | 9 |
| 1.2 Rear panel | 10 |
| 2 Connection | 11 |
| 2.1 Connection with the power supply | 11 |
| 2.2 Connection with the receiver | 11 |
| 3 Preparations | 12 |
| 3.1 Configuration of the receiver | 12 |
| 3.2 Start-up | 12 |
| 4 Basics | 13 |
| 4.1 Control | 13 |
| 4.2 Display | 14 |
| 4.3 Main key layout | 15 |
| 4.4 Clear (CLR) key | 16 |
| 4.5 Default mode and clear mode | 16 |
| 4.6 When the communication with the companion receiver has failed | 16 |
| 5 Configuration of the SDU5600 | 17 |
| 5.1.1 Configuration (CONF) | 17 |
| 5.1.2 Applicable receivers | 18 |
| 5.2.1 Configuration of the receiver | 19 |
| 5.2.2 Selecting the receive frequency | 20 |
| 5.3 Setup of the monitoring mode | 22 |
| 5.4 Basic setup for each monitoring mode | 23 |
| 5.4.1 Spectrum analysers mode | 23 |
| 5.4.2 Step resolution mode | 24 |
| 5.4.3 Channel scope mode | 25 |
| 5.4.4 Common features shared by different monitoring | 26 |

| | |
|---|-----------|
| 5.5 Marker | 28 |
| 5.6 Calculation facility | 30 |
| 5.7 Waterfall display facility | 31 |
| 5.8 On/off of the display information | 32 |
| 5.9 Beep alert | 32 |
| 5.10 Factory default/reset | 32 |
| 6 Operating the SDU5600 | 33 |
| 6.1 Operate the SDU5600 with the AR5000A+3 | 33 |
| 6.2 Monitor the VHF FM band in the spectrum analyser mode | 34 |
| 6.3 Monitor the FM broadcast band in the step resolution mode | 35 |
| 6.4 Monitor the VHF air band in the channel scope mode | 36 |
| 6.5 Suitable applications of each monitoring mode | 37 |
| 7 Useful information | 38 |
| 8 SDU5600 Computer control | 39 |
| 8.1 Communication parameters and connecting lead | 39 |
| 8.2 Delimiter | 39 |
| 8.3 Basic format of the command | 40 |
| 8.4 RS232 command list | 40 |
| Spectrum analysis | 41 |
| Visual command | 43 |
| User interface | 44 |
| General information | 46 |
| Notes for programmers | 48 |
| 9 Specification | 49 |

Every effort has been made to make this manual correct and up to date. Due to continuous development of the product and by error or omission, anomalies may be found and this is acknowledged.

© This manual is protected by copyright AOR Ltd 2003. No information contained in this manual may be copied or transferred by any means without the prior written consent of AOR Ltd. AOR and the 'AOR logo' are trade marks of AOR Ltd. All other trade marks and names are acknowledged. **E&OE**

Level of risk

As there SDU5600 is powered from 12V DC, there is little chance of serious injury as long as common sense is applied.

Observe the polarity of connections if the supplied AC power unit is not being used. DC input is a nominal 12V DC wired centre positive. Reverse polarity connection will damage the SDU5600 and potentially could lead to the risk of fire or explosion under severe circumstances.

Carefully handle the AC plug of the supplied AC power unit to prevent touching the terminals when inserting or removing from the AC socket. NEVER connect the SDU5600 directly to the AC supply.

SAFETY NOTICE - Always disconnect the power supply from the AC socket when not in use.

Explanation of risk warning mark

Whenever the book symbol  is used in this operating manual, an important point is being made which may relate to risk of personal injury or damage to the unit if ignored.

When the pointing finger  is used, the associated text provides useful operational information of special note (such as a tip). No risk or personal injury or damage is associated.

Handling the SDU5600

Use a soft, dry cloth to gently wipe the SDU5600 clean, never use abrasive cleaners or organic solvents which may damage certain parts. Treat the unit with care, avoid spillage or leakage of liquids into the cabinet and power supply. Special care should be taken to avoid liquid entering around the keys, main dial or via the connection sockets. *Never push or knock the TFT LCD display screen which is very fragile and sensitive to shock.*

Special remarks

Do not use or leave the SDU5600 in direct sunlight (especially the TFT display). It is best to avoid locations where excessive heat, humidity, dust and vibration are expected. Always keep the SDU5600 free from dust and moisture.

AC adaptor (power unit)

The SDU5600 may be provided with either a suitable AC / DC power unit. The SDU5600 is designed for operation from a nominal 12V DC regulated power supply (12 to 14V is acceptable), which should be capable of supplying a minimum of 1A continuous, ideally a 2A unit should be employed.

 Note: Never connect the SDU5600 directly to an AC supply.

The DC input socket uses a mini power connector (subject to EIAJ RC-5320A) and is wired centre positive (+), the chassis of the unit is at negative ground. To minimise the potential for power cable interference, it is suggested that a ferrite clamp be fitted to the connecting cable.

Other warnings

There are no internal operator adjustments. In the unlikely event of servicing being required, please contact your dealer for technical assistance.

Should the SDU5600 appear to behave strangely, normal operation may easily be regained by resetting the microprocessor. Simply power down the SDU5600 and disconnect the power supply... leave for 30 seconds then reconnect and power-up again.

It is possible to RESET the microprocessor, please refer to section 5-10, page 32 for further information.

If used with the AR3000A, a small modification is required to the receiver in order to provide the required 10.7 MHz IF output. If using the ICOM IC-R7100, the optional ICOM CT17 (RS232/CIV) interface is required.

SDU5600 Brief circuit description

The RF signal is fed by BNC socket into the SDU at a selected frequency of either 10.7MHz or 45.05MHz depending on the radio IF frequency being used. This signal is split into two different signal paths depending upon which input frequency is selected. Both paths are buffered and have Band Pass Filters with a bandwidth of +/-5kHz to eliminate unwanted signals outside of this range.

After the BPF, both signal paths join and are amplified by a single LNA (Low Noise Amplifier). The output signal feeds a pair of Dual Balanced Mixers.

Here the input RF signal is mixed with two orthogonal sinusoidal signals produced by the DDS (Direct Digital Synthesis) section to give two resultant signals at audio frequencies (one used as real, one as imaginary). The gain of both signal paths is also controlled at this point.

The audio level signals are fed through 80kHz LPFs (Low Pass Filters) and finally converted from Analogue into Digital signals before being fed to the FPGA (Field Programmable Gate Array).

The digital signal is now processed by the DSP (Digital Signal Processor) to give an RGB Video output via the FPGA which drives a colour TFT LCD display.

The DSP is controlled by the main CPU and its EEPROM memory. The front panel keypad switches and rotary encoder are fed to the main CPU via a separate slave microprocessor on the front panel.

RS232 control and Receiver control ports connect (indirectly) to the main CPU.

A comprehensive power supply section has been used in the unit to give the required supply levels of 2.5v, 3.3v, 5v, 6v, 9.5v, 17v, -5v, -7v and -15v. The input is protected for reverse current & unwanted RF and is internally fused.

LCD resolution

The LCD provides high resolution of 320 horizontal dots from the left to right edges of screen. As a result, there are about 40 steps per graticule division with eight divisions making up the total width. The minimum displayed bandwidth is 160kHz and the maximum displayed width is 10000 kHz (10 MHz) representing ± 5 MHz.

To calculate the LCD-step, divide the SPAN bandwidth in kHz by 320. Examples are as follows:

| | |
|--------------------|------------|
| 10000 kHz (10 MHz) | 32.250 kHz |
| 5000 kHz (5 MHz) | 15.625 kHz |
| 2000 kHz (2 MHz) | 6.250 kHz |
| 1000 kHz (1 MHz) | 3.250 kHz |
| 160 kHz (0.16 MHz) | 0.500 kHz |

It is possible to force the LCD-step to equal the receive tuning step using a similar process. Multiply the receive tuning step size in kHz by 320 (dots) to obtain the required total span width in kHz.

For example, for a 5 kHz tuning and LCD step, $5 \times 320 = 1600$ kHz span

The following table presents commonly used step sizes:

| | |
|-----------------------------|---|
| 0.5 kHz (minimum step size) | 160 kHz (0.160 MHz) |
| 5 kHz | 1600 kHz (1.600 MHz) |
| 6.25 kHz | 2000 kHz (2.00 MHz) |
| 9 kHz | 2880 kHz (2.880 MHz) |
| 10 kHz | 3200 kHz (3.200 MHz) |
| 12.5 kHz | 4000 kHz (4.000 MHz) |
| 20 kHz | 6400 kHz (6.400 MHz) |
| 25 kHz | 8000 kHz (8.000 MHz) |
| 31.25 kHz | represents maximum span of 10000 kHz (10 MHz) |

SLU68602 Block Diagram

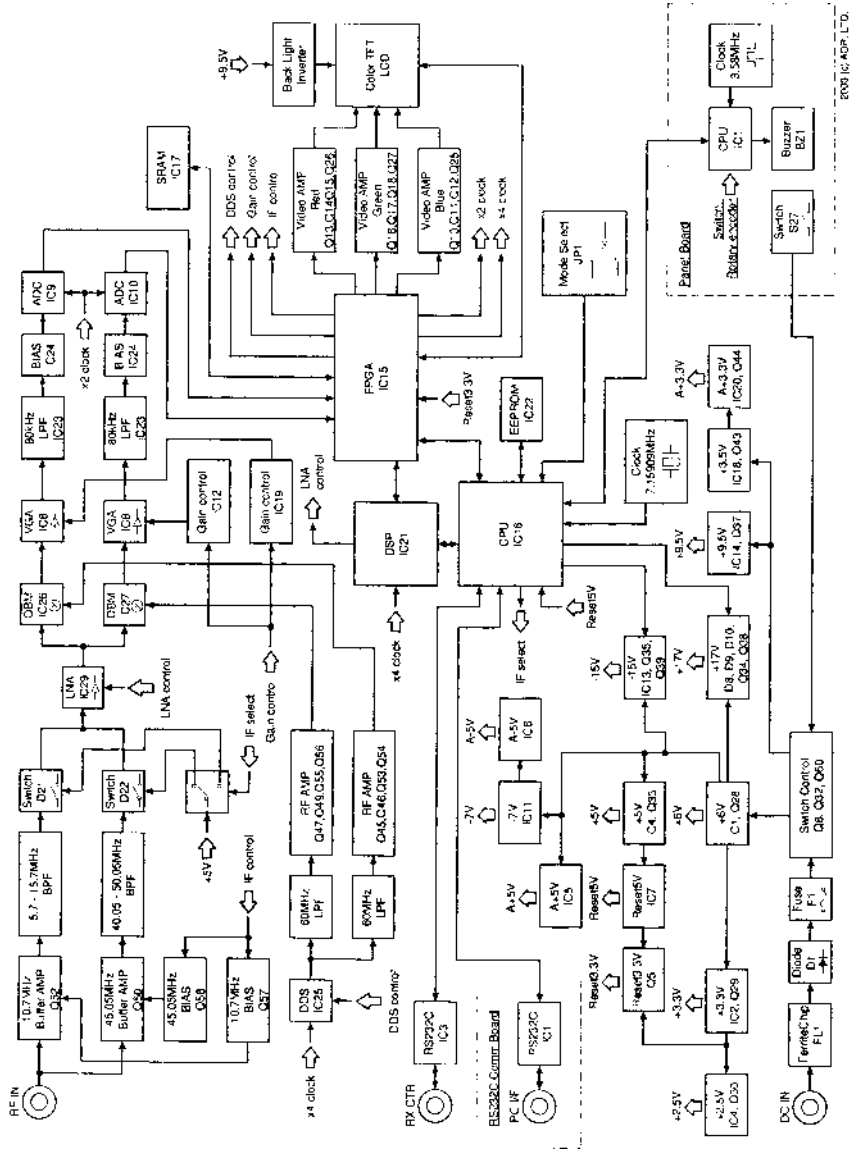

Introduction

Thank you for purchasing the SDU5600 FFT spectrum display unit. AOR was the first company in the world to market a colour spectrum display unit (SDU5000) for professionals and the top-end of hobbyist listeners. The SDU5500 followed adding sophistication and the SDU5600 is truly a successor incorporating a high resolution 5 inch (127mm) colour TFT display featuring FFT signal analysis and built-in waterfall display backed by the latest microprocessor technology to ensure high versatility and reliability. To get the best possible results, we recommended that you read this manual to fully familiarise yourself with the SDU5600.

Major features

The SDU5600 has been designed to be a highly effective spectrum monitor unit which is capable of digitally processing the IF frequency taken from a communications receiver through the use of FFT for professional quality spectrum analysis. The 5 inch TFT colour LCD screen is used to achieve the finest possible resolution.

The SDU5600 has been primarily designed to complement to the AOR AR5000 series of receivers in terms of operational features and cosmetic design. Also other types of receiver such as the AOR AR-ONE, AR3000A and AR8600MK2 and ICOM ICR8500 + ICR7100 can be used (modification and additional hardware required).

A wide variety of monitoring modes are available with the convenience of operators in mind which include **Step Resolution Mode** for general monitoring or **Channel Scope Mode** for monitoring the channelised signals. It also incorporates a **Waterfall facility** (as commercial grade spectrum analysers do), to display the changing conditions of signal spectrum with varying colours in a form of waterfall.

Following the success of its predecessors, SDU5000 and SDU5500, the new SDU5600 provides the same **AV, Peak Hold and Peak** value readings which are downloadable to the PC via a communications port. The SDU5600 can be remote controlled through the use of the communications port to further expand the range of applications for spectrum monitoring.

Supplied accessories

| | |
|-----|---|
| 1 x | SDU5600 main unit |
| 1 x | BNC RF patch lead for IF connection |
| 1 x | DB9 patch lead for serial communications - male to male |
| 1 x | Handbook |
| 1 x | AC power supply |

1 Controls and Descriptions

Control and display of the SDU5600 is via the front panel with the rear panel providing connections for the companion receiver, power and computer.

1-1 Front panel

LCD: The large high resolution 5 inch colour TFT display provides all operational information and spectrum display. The background is black with green graticule and white lettering for critical information. Menu items are varying shades of blue, the valid indicator is green with the function indicator in 'reverse lettering' yellow. The marker line is white and changes to purple when exactly positioned over a graticule line. The colours cannot be changed.

Power switch: Press once to latch the switch in, switching on the SDU5600. To switch off the SDU5600, press the switch a second time, the switch latches outward. When switched on, the LCD briefly displays the model and firmware numbers.

Tilt bail bar: A tilt bail bar is provided under the front panel (on the bottom case half) so that the SDU5600 may be tilted upward at the front to improve visibility in certain installations.

Soft function keys: Each one of these three 'soft keys' has multiple roles as indicated on the LCD screen depending on the circumstances in operation.

Special function keys: These three keys positioned to the left of the DIAL are to be used solely for specific purposes such as to enter a centre frequency, frequency span, display increment and input sensitivity.

Dial: The DIAL is a rotary control and is used to move the cursor, to make a selection or to move the marker/centre frequency.

Main keypad: Used to enter numeric information, to control the companion receiver, etc. When a valid key press is sounded, the SDU5600 will provide a high pitch 'beep' (happy), if an invalid key press is made, a low pitched 'beep' (sad) is sounded. The beep can be toggled on/off using the key sequence **FUNC + 6** (BEEP), the default is on.

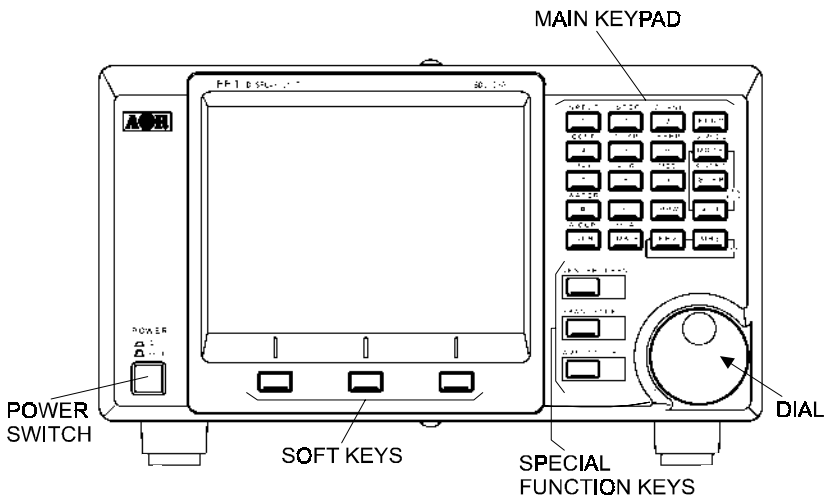

1-2 Rear panel

RF Input socket: The IF output (10.7 MHz / 45.05 MHz) from a suitable receiver such as the AR5000A should be connected to this BNC input socket using a 50 OHM patch lead constructed of quality coaxial cable such as RG58/U, UR43, UR76 etc. A suitable BNC-BNC lead is supplied.

PC I/F socket (male): A controlling computer may be connected to this 9-pin D-type male socket. Ensure this socket is only commented to a computer for hands-off operation, although it is very unlikely that incorrect connection to a computer or similar device would cause damage.

RX connection socket (female): The supplied 9-way to 9-way 'D-type' male to male lead is used to connect the SDU5600 to the AR5000A receiver. If used with another receiver, a suitable serial-adaptor or connecting cable will be required. Wiring should be as follows:

| SDU5600 9-pin male | 9-pin male (AR5000A) | 25-pin male (AR3000A) |
|--------------------|----------------------|-----------------------|
| 2 | 2 | 3 |
| 3 | 3 | 2 |
| 5 | 5 | 7 GND |
| 7 | 7 | 4 |
| 8 | 8 | 5 |

12V DC input socket: The supplied power unit is terminated with a centre positive (+) polarity. The plug specification follows EIAJ RC-5320A (Class-4).

There are four screw holes (unused), two on each side of the cabinet. They are a provision for rack mount application. Size of the screw is M4x8.

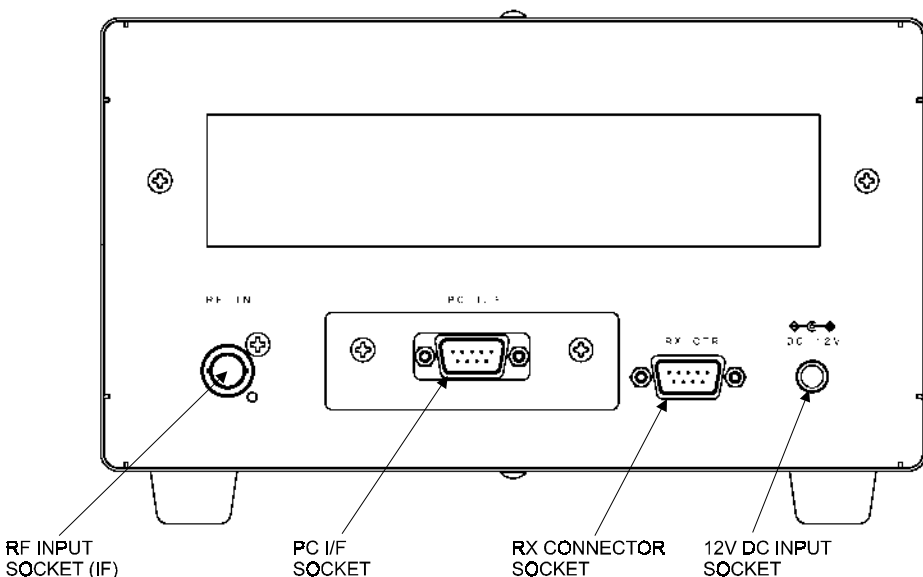

2 Connection

2-1 Connection with the power supply

Where possible, use the supplied AC/DC power unit. Make sure the main switch of the SDU5600 is in the OFF position before connecting the power supply.

2-2 Connection with the receiver

This hand book is compiled mainly referring to the AR5000A series receiver as the principal companion receiver. Any reference to other types of receiver will be made separately when and where necessary.

Make sure that both the SDU5600 and AR5000A are switched off. Perform the connection of the both units referring to the photo shown here, using the IF signal connection patch lead and RX serial connection lead. The following table shows the correct connection of each plug & socket.

| | AR5000A | SDU5600 |
|-----------------------------|---------|---------|
| IF signal patch lead | IF OUT | RF IN |
| RX serial lead | REMOTE | RX CTR |

If you wish to use a receiver other than the AR5000A proceed to connect the 10.7MHz IF output from the receiver to the **RF IN** BNC socket on the rear of the SDU5600... the AR3000A will require a modification in order to provide a suitable signal. Connect the RS232 data lead from the receiver to the **RX CTR** socket of the SDU5600, the companion receiver 'thinks' it is communicating with a computer, but is actually communicating with the SDU5600 (the ICOM ICR7100 requires the optional ICOM CT17 CIV/RS232 interface).

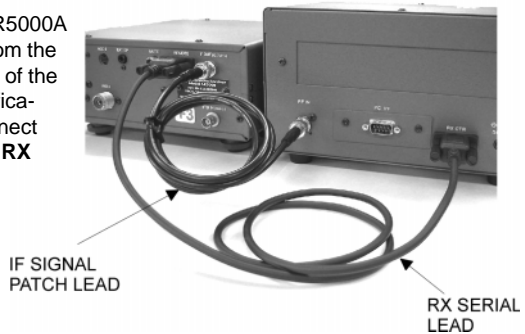

| RX Menu | Applicable receiver | Requirements |
|--------------|--|--|
| AR5000 | AR5000A+3 AR5000A AR5000+3 AR5000 | Configure the IF output |
| AR3000A | AR3000A (AR3000 not applicable) | Modifications to the IF output circuit |
| AR8600 (10M) | AR8600MK2 | Modifications to the output circuits on all modes other than WFM |
| AR8600 (45M) | AR8600MK2 | Modification of TV converter |
| AR8200 | AR8200MK2 AR8200MK3 | Modification of TV converter and use of 8200PC interface |
| AR-ONE | AR-ONE | Configure the IF output |
| RFU5600 | RFU5600 | |
| IC-R8500 | IC-R8500 | Use of batch lead with RCA/PHONO plug Configure the IF output |
| IC-R7100 | IC-R7100 | Use of batch lead with RCA/PHONO plug Use of CT-17 interface |

The SDU5600 offers a RX selection menu whereby you can select other receivers which you wish to operate with the SDU5600. The table here indicates the type of receiver in the RX selection menu, applicable receivers and other requirements.

3 Preparations

3-1 Configuration of the receiver

The SDU5600 is primarily designed to operate with the receiver at 9600bps. The companion receiver's baud rate has to be configured to the same rate. Some type of receivers may require additional modifications or interface, etc, which are explained as follows:-

AR5000 series: Configure the selection of external IF output and baud rate as per the following table (refer to pages 29 & 30 sections 6-18 & 6-19 of AR5000 English language operating manual):

| | |
|---------------------------|-------------------|
| External IF output | Select [EXT-IF 1] |
| RS232C | Select 9600bps |

After the configurations have been completed place the receiver in VFO mode.

AR3000A: The AR3000A has to be **modified by AOR** in order to produce a 10.7MHz IF output for use with the SDU5600. The remote switch on the rear panel has to be set to ON position, and baud rate needs to be 4800bps (receiver's default). A screened RS232 connecting lead configured for 9-25 pin with male-pins at both ends must be used.

AR8200MK3: Configure the baud rate to 9600bps by referring to pages 109 & 110 section 14-6 of the AR8200 English language operating manual. Place the receiver in VFO mode. For connection to the SDU5600 the 8200PC interface lead is required along with a gender changer. The AR8200MK3 has to be **modified by AOR** to produce a 10.7MHz IF output.

AR8600MK2: Configure the baud rate to 9600bps by referring to page 108 section 14-5 of AR8600 English language operating manual. Place the receiver in VFO mode. For connection to the SDU5600 the supplied connecting leads have to be used. To enable IF output in ALL MODES (rather than just WFM), refer to page 18 for further information on the **modifications required**.

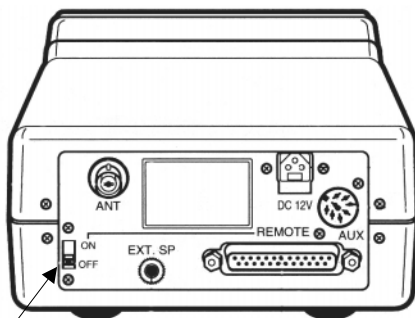

**RS232 SWITCH MUST BE ON
AR3000A REQUIRES MODIFICATION
FOR 10.7MHz IF OUTPUT**

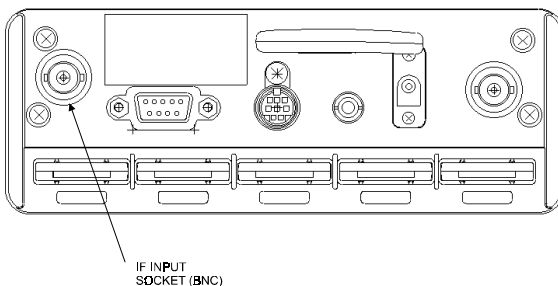

IF INPUT
SOCKET (BNC)

3-2 Start-up

ALWAYS switch the receiver on before the SDU5600 and make any necessary adjustment of communication speed and IF output (assuming the relevant modifications have been carried out and connecting leads are in place as appropriate). Then switch on the SDU5600 by depressing the POWER switch on the lower left of the front panel. The SDU5600 will power up, while the operating system powers up you may notice horizontal lines on the LCD, this is normal. The SDU5600 will briefly display the model number and firmware version called the 'opening message' before the standard display. The SDU5600 is ready for operation.

4 Basics

This section describes the front panel controls, detail of LCD display and introduces the method of operation employed by the SDU5600 prior to further configurations and monitoring operations. It is advisable that you read this section carefully before proceeding to explore the full capability of the SDU5600.

4-1 Control

Power switch: Press once to latch the switch in, switching on the SDU5600. To switch off the SDU5600, press the switch a second time, the switch latches outward. When switched on, the LCD briefly displays the model and firmware numbers.

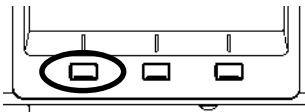
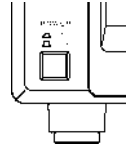

Soft function keys: Each one of these three 'soft keys' has multiple roles as indicated on the LCD screen depending on the circumstances in operation. Throughout this manual, physical keys and 'soft keys' are not differentiated when describing key sequences.

Special function keys: These three keys positioned to the left of the DIAL are to be used solely for specific purposes such as to enter a centre frequency, frequency span, display increment and input sensitivity.



Dial: The DIAL is a rotary control and is used to move the cursor, to make a selection or to move the marker/centre frequency.

Main keypad: Used to enter numeric information, to control the companion receiver, etc.

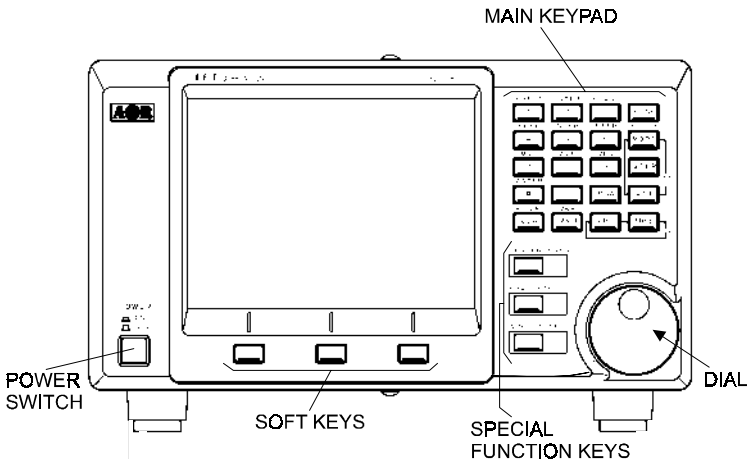

BACKUP

The SDU5600 is configurable in various ways to the requirements of the operator. All configuration data is stored into FLASH ROM when the SDU5600 is switch off. However, in the event of failed connection / communications with the companion receiver, a beep will be sounded and the SDU5600 will revert to the factory default parameters.

4-2 Display

This section explains what you can expect to see on the SDU5600's monitor screen using **Spectrum Mode** as a typical example. The screen will appear differently when switched to other operating modes.

(1) Centre frequency - CF: The **centre frequency** reading is shown in MHz, providing a minimum resolution of up to 10Hz.

(2) Frequency span - SPAN: The centre frequency appears in the middle of the display with frequency extending to the left and right. The total frequency spread from the left through centre to the right is referred to as the total SPAN and is indicated in MHz. The maximum span is 10MHz and minimum is 0.160MHz (160kHz). The horizontal scale is divided into 320 increments.

(3) Start frequency - SF: Displays the start frequency on the left of the graticule for calibration purposes. Usually the start frequency is calculated based on the centre frequency and bandwidth selected, but in certain menus can be directly programmed.

(4) End frequency - EF: Displays the end frequency on the right of the graticule for calibration purposes. Usually the end frequency is calculated based on the centre frequency and bandwidth selected, but in certain menus can be directly programmed.

(5) Resolution band width - RBW: The sampling filters may be selected from four bandwidths of 4kHz, 32kHz, 64kHz and 128kHz. The smaller bandwidths will provide greater detail of individual signals but wanted transmissions are easier to initially identify using a wider filter.



Relationship between Frequency span and Frequency step

The LCD provides high resolution of 320 steps from the left to right edges of the screen (x-axis). A frequency bandwidth represented by one step is calculated as $STEP = \frac{SPAN}{320}$, this being automatically done by the SDU5600 in the Spectrum Mode. Refer to item (6) 'Frequency step' on page 15.

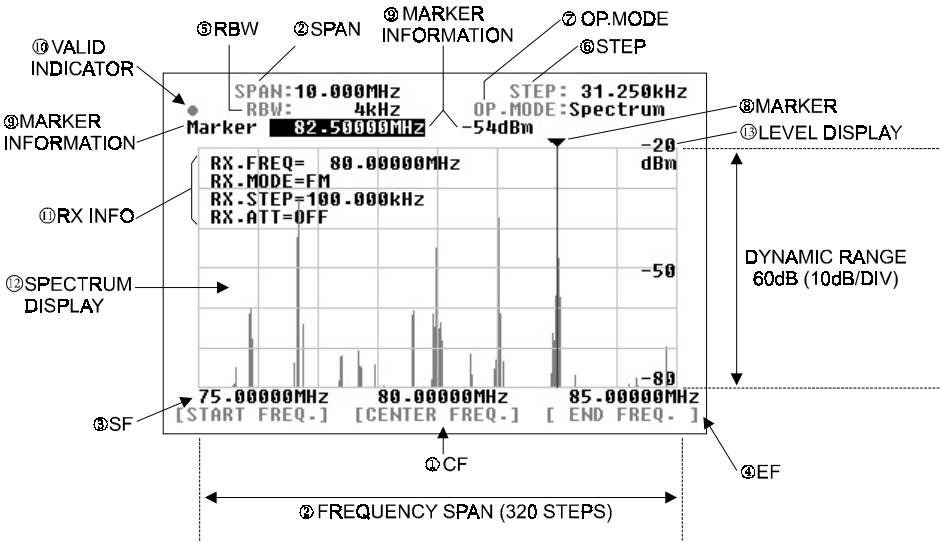

(6) Step frequency - STEP: This value is displayed in kHz and indicates how wide one step represents out of the 320 steps across the X-axis. The example of page 14 shows 31.250kHz as one step which is obtained by taking the SPAN of 10MHz and dividing it by 320, the result is 31.250kHz - since the X-axis is 10MHz wide in this example. In the **Step resolution mode**, it is possible to specify the frequency bandwidth to be 'one step' rather than an often seemingly arbitrary value.

(7) Operation mode - OP.MODE: This legend indicates which one of three operating modes is selected, there are three possibilities:

| | |
|-----------------|------------------------|
| Spectrum | Spectrum analyser mode |
| StepReso | Step resolution mode |
| Channel | Channel scope mode |

(8) Marker + (9) Marker information: The marker (8) is a vertical line drawn on the LCD which can be moved across the horizontal axis. The marker is capable of providing the instantaneous reading of information where the marker is placed such as (9) frequency or signal strength of marker location. In the marker menu, in addition to the **instantaneous reading** of marker information, the **peak search** facility is provided. Any signals which are out of scale cannot be read. It is necessary to adjust the gain for input signal level, the displayed signal appears vertically while the calibration lines of the graticule are represented horizontally.

(10) Valid indicator: This indicates which method of data input is valid. When a DOT ● is shown, the main dial is operational whereas when SQUARE ■ is displayed, entry through the keypad is operational.

(11) Receiver information: This section of the LCD provides various operating conditions of the companion receiver such as receiving frequency, modulation mode, tuning step and ATT on/off. The information can be toggle on and off via the key sequence **FUNC 5 (DISP)**

(12) Signal indicator + (13) Level indicator: The X-axis (horizontal line) indicates frequency, and Y-axis (vertical line) indicates signal strength, so the frequency spectrum of the received signal is indicated on the screen.

The Y-axis (vertical line) is split into six segments with each segment representing a 10dB. The level indicator reads the input sensitivity which is shown along the Y-axis and the level is adjustable in four levels by altering the built-in amplifier (AMPLITUDE). The X-axis is split into eight segments indicating the frequency span (bandwidth) in use. The marker is designed to move across the one segment by ONE full rotation of the main dial. To move the marker from one edge to another requires EIGHT rotations of the main dial.

4-3 Main key layout

The main key pad consists of 20 individual keys, each conveniently located for ease of operation:

- ★ Function key (**FUNC**) on the top right
- ★ Receiver control keys (**RX CTRL**) on the right
- ★ Enter key (**ENT**) on lower right
- ★ Clear key (**CLR**) on bottom left

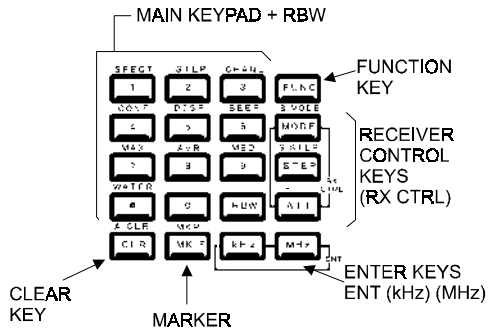

The **FUNC** key enables activation of the second function keys. When pressed the 'FUNC' legend appears in the top left corner of the LCD in reverse contrast YELLOW text.

4-4 Clear (CLR) key

The clear key (**CLR**) acts as **back-space key** to cancel each proceeding key entry of numeric information (**1 to 0, decimal-point**) during entry of the start /end frequency, entry of input sensitivity / trigger level or the marker and numeration in the calculation mode. Pressing the clear key with no proceeding key entry will abort the sequence. Pressing **A.CLR (FUNC + CLR)** will clear all proceeding numeric entries and end the sequence.

Pressing the clear key (**CLR**) repeatedly in the calculation mode, marker mode (except the instantaneous reading) and waterfall display mode will eventually return operation to the default mode, see below.

4-5 Default mode and clear mode

The SDU5600 is configurable with a wide range of parameters. It is possible to bring the SDU5600 to the default mode as described in the table by repeatedly pressing the clear key.

Definition of the default mode

| | |
|------------------|-----------------------|
| Marker mode | Instantaneous reading |
| Calculation mode | None |
| Waterfall mode | No display |

Pressing the clear key (**CLR**) will not affect the proceeding key entry in the monitoring mode (spectrum analyser mode, step resolution mode, channel scope mode), frequency span / frequency step, marker frequency and demodulation mode.

4-6 When the communication with the companion receiver has failed

The SDU5600 will try to re-establish the communication with the receiver for a couple of seconds. If unsuccessful the SDU5600 will revert itself to the default mode as 4-5.



Default mode in the monitoring mode

When the communication between the SDU5600 and the companion receiver has been disrupted while operating in the channel scope mode the SDU5600 will automatically switch itself from the **channel scope mode** to **spectrum analyser mode**, ending up in the default mode.

5. Configuration of the SDU5600

The SDU5600 is designed to configure a wide range of parameters for ease of operation.

5-1-1 Configuration (CONF)

This section explains how to configure the operating environment under which the SDU5600 is used. **Selection of the receiver, Plotting pattern** and **Frequency direction** are to be configured. Press the **FUNC** key followed by the **4** (CONF) key to assign the soft keys as the following diagram.

For **selection of the receiver** press the **RX** key.

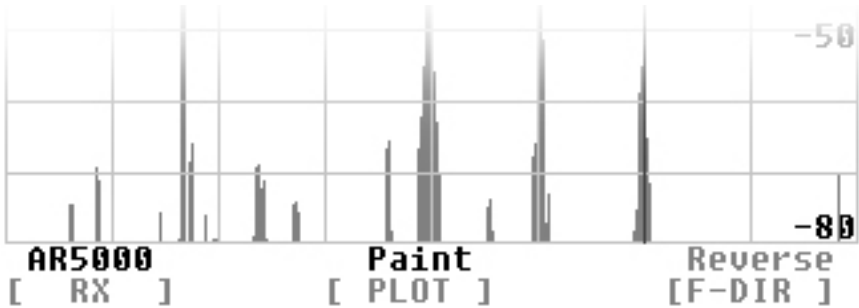

The box where the type of receiver is shown will be in reverse contrast. Rotate the main dial to scroll through applicable receivers one after another. Press the **ENT** key (**kHz** key or **MHz** key) to determine the companion receiver. There are no other features of the RX configuration menu.

For selection of the plot pattern press **PLOT** key. The present pattern is shown either as **Paint** or **Outline**. If you wish to change the pattern from the one to another press the **PLOT** key. There are no other features of the PLOT configuration menu.

This illustration shows PAINT mode:

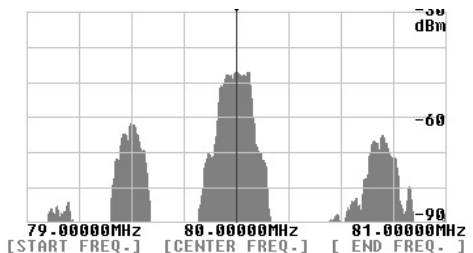

For selection of the **frequency direction** press the **F-DIR** key. The present selection is shown either as **Reverse** or **Normal**. Press the **F-DIR** key to toggle between Reverse and Normal. This configuration is valid only when the companion receiver has been selected as **Other(10M)** or **Other(45M)**, it is not applicable when a 'known' valid radio is connected. There are no other features of the F-DIR configuration menu.

This illustration shows OUTLINE mode:

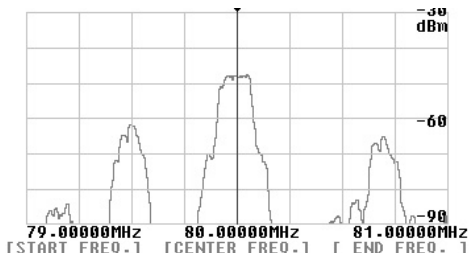

5-1-2 Applicable receivers

This is a list of compatible receivers which are selectable from the SDU5600 companion receiver menu:

| Receiver Selection menu | Applicable receiver | Remarks |
|-------------------------|-------------------------------|--|
| AR5000 | AR5000/+3 AR5000A/+3 | Use of EXT-IF port |
| AR3000A | AR3000A | 10.7MHz IF mods required Use of 4800bps |
| AR8600(10M) | AR8600MK2 | IF mods required if used in all modes |
| AR8600(45M) | AR8600MK2 | 45MHz IF mods (TV mods) required |
| AR8200 | AR8200MK3 | 45MHz IF mods (TV mods) required |
| AR-ONE | AR-ONE | |
| RFU5600 | RFU5600 | Built-in RF adaptor |
| IC-R8500 | IC-R8500 | |
| IC-R7100 | IC-R7100 | CT-17 required |
| Other(10M) | Receiver with 10.7MHz out | Frequency direction selectable |
| Other(45M) | Receiver with 45.05MHz out | Frequency direction selectable |

Non-AOR receivers are excluded from our terms and condition which are applicable to AOR receivers in respect of electrical performance and specifications.

For modifications, please contact AOR:

Japan

AOR Ltd, Tel: +81 3 3865 1695 www.aorja.com

Americas

AOR USA INC., Tel: 310 787 8615 www.aorusa.com

5-2-1 Configuration of the Receiver

This section explains how to configure the companion receiver itself. **Note that this section will not apply when Other(10M) or Other(45M) has been selected** in the receiver selection menu, or communication has not been correctly established between the SDU5600 and companion receiver.

On the right of the main keypad there are three control keys which directly affect the operation of the companion receiver, these are **MODE** (receive mode), **STEP** (tuning step) and **ATT** (attenuator). Their operation in companion with the SDU5600 is described below.

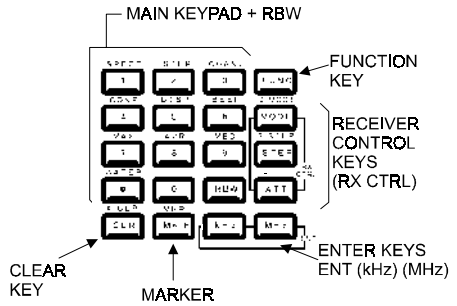

Receive (Demodulation) mode - MODE

This key is used to select the receive mode of the companion receiver (NFM, AM etc). Press the **MODE** key to activate the **RX.MODE** menu, the corresponding LCD legend flashes in reverse contrast. Rotate the main dial to scroll the various receive modes. Press the **ENT** key to accept the displayed the receive mode.

Frequency step - STEP

This key is used to select the tuning step size of the companion receiver. Press the **STEP** key to activate the **RX.STEP** menu, the corresponding LCD legend flashes in reverse contrast. Tap in the step size via the ten-keys then press the **ENT** key. **Any step size which is not supported by the companion receiver will be rejected** by the SDU5600 and the LCD will revert to the previous step size.



Attenuator - ATT

This key is used to activate or deactivate the attenuator of the companion receiver as a toggle, each push of the **ATT** key will alternate On/Off and the corresponding LCD legend **RX.ATT** will confirm the status.

AUTO mode of the companion receiver



When the companion receiver is equipped with an **auto mode** feature where the **IF filter bandwidth** and **receive mode** can be changed independently (such as the **AR5000A**), the SDU5600 cannot make changes to the IF bandwidth. For this reason, **it is suggested that auto mode be used** or the bandwidth selected manually if only one receive mode is to be used while operating with the SDU5600 in the current session.

Revert to the parameters which have been previously configured

- ★ Press **FUNC + S.MODE/MODE** to revert to the **previously selected receive mode**.
- ★ Press **FUNC + S.STEP/STEP** to revert to the **previously selected receive tuning step size**.
- ★ Note, these facilities do not operate once the SDU5600 has been switched off and on.

Value of the attenuation (amount of attenuation)

The amount of attenuation is determined by the attenuator of the companion receiver. With the AR5000 series receiver the attenuation can be manually selected from the receiver' front panel. However when the attenuator is switched on from the SDU5600's front panel it will select only the AUTO position of the receiver.

5-2-2 Selecting the receive frequency

This section will explain how to select and monitor the receive frequency of the companion receiver. It must be noted that the SDU5600 employs the following principle:

Spectrum / Step Resolution - Receive Frequency (RX.FREQ) = Centre Frequency (CF)

Method 1: While the SDU5600 is in SPECTRUM MODE (default when first switched on) or STEP RESOLUTION MODE, use the ten keys to directly enter the desired centre frequency, followed by the kHz or MHz key to complete the sequence.

Method 2: Usually the main dial changes the position of the marker, however press the **CENTRE FREQ.** soft key to display the *CF legend* in reverse contrast (as diagram below), now you can alter the centre frequency by turning the *main dial* as well as via the *keypad*. The frequency step in use is as selected by the SDU5600 (not the frequency step selected in the receiver), 20kHz in the example below. While tuning the receive frequency or CF by rotating the main dial there may be up to approx. 2 seconds of delayed response between the SDU5600 and the companion receiver.



Notes: If the companion receiver is of interactive type such as the AR5000 series the centre frequency can be operated via the receiver's tuning dial (or keypad depending on level on inter-operability). The frequency step in such use is as selected by the receiver (the diagram below shows a tuning step of 100kHz).

Receive frequency cannot be adjusted when the companion receiver has been selected as Other(10M) and Other(45M), the soft keys change colour to dark blue and the main keypad will not initiate frequency entry... producing an error beep if the feature is enabled. This is also true when communication between the SDU5600 and the companion receiver has been disrupted.

Pressing the ten keys to enter the centre frequency in the following instances will be void:

- ★ When the FUNC legend is shown in reverse contrast.
- ★ When the companion receiver has been selected as Other.
- ★ When the SDU5600 is in the marker mode following the key press of **FUNC + MK.F** keys.
- ★ While the SDU5600 is in a process of entering calculation data.

Once the entry by the ten-keys has been made, entry by the main dial is invalid. To resume the entry by the main dial press the **CLR** key once followed by the **CENTRE FREQ.** key.

Centre frequency and Receive frequency step:

- ★ The frequency step shown on the SDU5600's screen is valid when operated by the main dial.
- ★ The frequency step selected by the companion receiver is valid when the SDU5600 is being controlled by the companion receiver.

FUNC + 1
Spectrum mode

FUNC + 2
Step Resolution mode

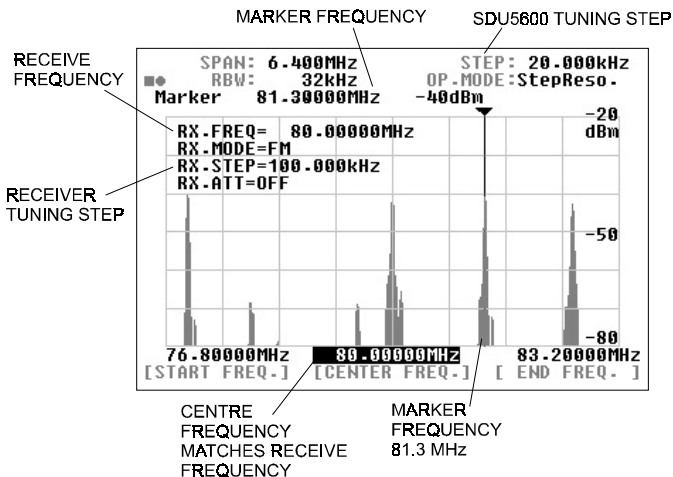

Channel scope mode

The previous page explains the receive frequency operation in the spectrum analyser mode and step resolution mode. The channel scope mode differs since it does not use the centre frequency (CF), instead the receive frequency equals the marker position:

Channel Scope Mode - Receive Frequency = Receive Marker position

In addition, by use of the marker receive key **MK.F** you can track and select any active receive frequency for monitoring within the frequency band presently shown on the screen.

FUNC + 3 selects *Channel Scope mode*

The currently selected centre frequency will become the new START frequency, the CHANNEL STEP is default 100kHz, the bandwidth is initially selected as 5MHz. You can change the start frequency, channel step and end frequency... or just press ENT three times to accept the current defaults.

Use the SDU5600 main dial to select a peak on the display to indicate the presence of an active channel, press **MK.F** to receive the new frequency. As you move the main dial again, you will note that a new yellow-outline marker appears at the current position on the display, this is the receive marker. You can toggle the display line to confirm **RECEIVE MARKER** frequency or **MARKER** frequency position using the key sequence **FUNC + MK.F** (MK.R). When **RECEIVE MARKER** is selected, a green dot ● is displayed on the LCD.

The channel scope mode cannot be selected when the companion receiver has been selected as Other(10M) or Other(45M), or the communications between the SDU5600 and the companion receiver has been disrupted.

The example of the channel scope mode here displays the following parameters:

Receive marker = 81.3MHz
 Receive frequency = 81.3MHz
 Marker position = 82.5MHz
 Start frequency = 79.0MHz
 Channel step = 25kHz
 End frequency = 83.0MHz

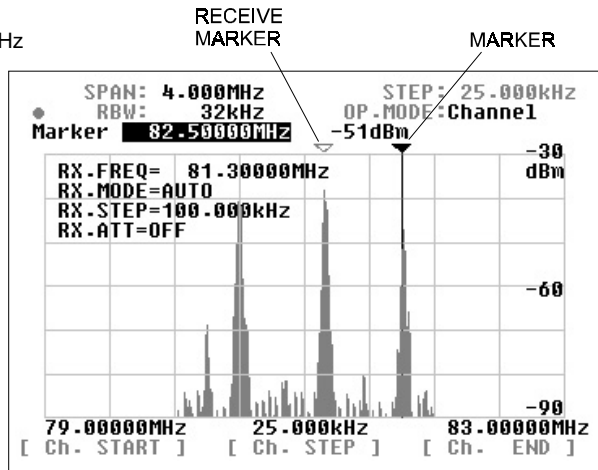

Receive marker [MK.F] key

In the spectrum analyser mode and step resolution mode press the **MK.F** key to swap the marker frequency for the centre frequency (CF). This is convenient if you wish to listen in the marker frequency immediately.

5-3 Setup of the monitoring mode

The SDU5600 is designed to provide 3 different monitoring modes such as the spectrum analyser mode, step resolution mode and channel scope mode. Choosing the most appropriate monitoring mode for your specific requirements is important to maximise performance and efficiency of the SDU5600.

Method of selecting each monitoring mode:

- Spectrum analyser mode Press **FUNC + 1** (SPECT)
- Step resolution mode Press **FUNC + 2** (STEP)
- Channel scope mode Press **FUNC + 3** (CHANL)

The **1, 2 and 3** keys are allocated with the 'second function'. The selected mode is displayed on the second line from the top-right side of the LCD as **OP.MODE**. Each mode has unique features.

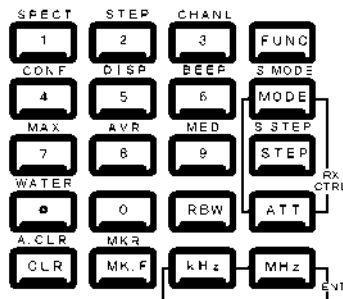

Spectrum analyser mode (SPECT)

This is most suited for general listening and to hunt for non specific signals or noise, by sweeping across the defined range of spectrum (up to a bandwidth of 10MHz).

Step resolution mode (StepReso)

This is most suited to monitor specific signals across a known relatively wide defined band where signals are allocated with a certain stepping size, for example VHF airband. The horizontal x-axis of the LCD has a resolution of 320 dots, each dot represents one step, so there are a total of 320 steps.

Channel scope mode (Channel)

This is most suited to monitor a known narrow channelised band of frequencies such as the VHF or UHF amateur band. Channel scope mode can emulate almost a real-time band scope between the start and end frequency with defined stepping size.

 When the companion receiver has been selected as **Other** the channel scope mode is disabled.

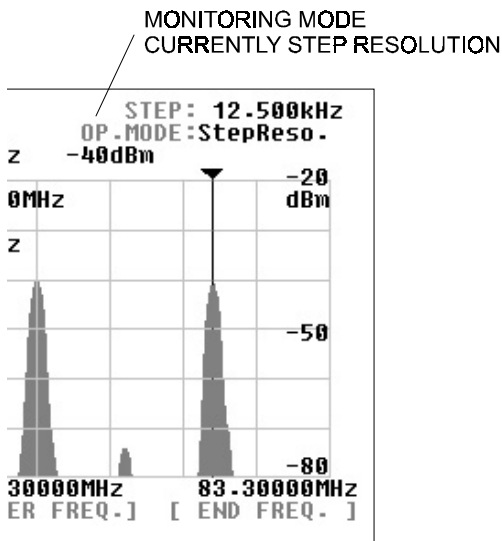

5-4 Basic setup for each monitoring mode

This section will explain how each monitoring mode has to be set up.

5-4-1 Spectrum analyser mode

Example of the screen is shown here, the parameters are as follows:

Centre frequency (CF) = 122.5MHz
 Frequency span = 10.0MHz
 Start frequency = 117.5MHz
 End frequency = 127.5MHz
 Marker frequency = 123.5MHz
 Operating step = 31.25kHz

Centre frequency (CF)

Press the **CENTRE FREQ.** key to make the centre frequency display read-out appear in reverse contrast. Enter a desired frequency via the ten-keys followed by the **kHz** or **MHz** key, this is now the centre frequency. The main dial of the SDU5600 may also be used to select a frequency, you must still use the **kHz** or **MHz** key to complete the frequency entry sequence.

Assuming that communication between the SDU5600 and the companion receiver has been correctly established, the centre frequency of the SDU5600 becomes the receive frequency of the companion receiver.

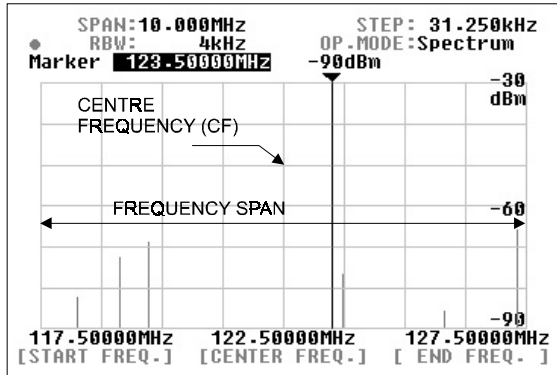

EACH INCREMENT IS DETERMINED BY THE
 BANDWIDTH DIVIDED BY HORIZONTAL
 RESOLUTION

$$10\text{MHz} / 320 = 31.25\text{kHz}$$

Frequency span (SPAN)

Press the **SPAN/STEP special key** to reverse the contrast of SPAN numeric display on the top line of the LCD.

Enter the frequency span (range / bandwidth), over which you wish to monitor using the ten-keys followed by the **kHz** or **MHz** key to confirm the entry. Once the frequency span has been entered the display step will be automatically calculated and displayed as **STEP** on the top line of the LCD to the right of the **SPAN**.

Start frequency and end frequency

The **START** and **END** frequency can be entered in the same manner as the centre frequency entry using the assigned soft keys, ten-keys and **ENT** key. The main dial is not valid for the entry.

Special key - CENTRE FREQ.

This hardware special key is a duplicate of the soft key **CENTRE FREQ.** and has identical action. Either key may be used to the same effect.

Enter key MHz/kHz

SDU5600 has TWO ENTER KEYS, either may be used to complete key sequences. When inputting frequencies, you may use kHz or MHz format. For example, ten-MegaHertz may be entered as:

1 0 MHz

or

1 0 0 0 kHz

Example of the automatic calculation of the display step

In the above illustration, the frequency SPAN is 10MHz, so the STEP (incremental resolution of the horizontal x-axis) is automatically calculated as:

$$10\text{MHz} \text{ divided by } 320 = 31.25\text{kHz}$$

5-4-2 Step resolution mode

Example of the screen is shown here, the parameters are:

Centre frequency (CF) = 122.5MHz
 Display step = 25kHz
 Frequency span = 8MHz
 Start frequency = 118.5MHz
 End frequency = 126.5MHz
 Marker frequency = 124.35MHz

In the step resolution mode, the frequency span is determined by the entry of display step size, which is OPPOSITE to the spectrum analyser mode where the display step size is determined by the entry of frequency span.

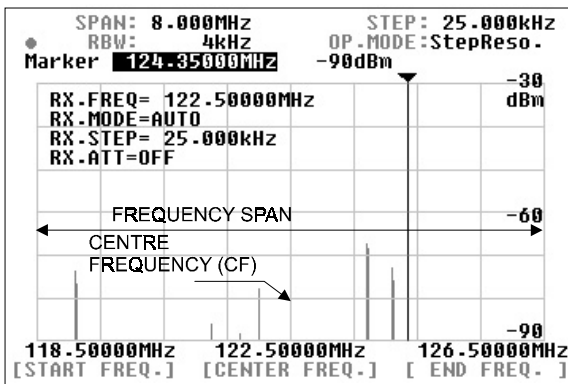

THE SPAN IS DETERMINED BY THE STEP SIZE MULTIPLIED BY HORIZONTAL RESOLUTION

$25\text{kHz} \times 320 = 8\text{MHz}$

Centre frequency (CF)

Press the **CENTRE FREQ.** key to make the centre frequency display read-out appear in reverse contrast. Enter a desired frequency via the ten-keys followed by the **kHz** or **MHz** key, this is now the centre frequency. The main dial of the SDU5600 may also be used to select a frequency, you must still use the **kHz** or **MHz** key to complete the frequency entry sequence.

Assuming that communication between the SDU5600 and the companion receiver has been correctly established, the centre frequency of the SDU5600 becomes the receive frequency of the companion receiver.

Display step (STEP)

Press the **SPAN/STEP special key** to reverse the contrast of STEP numeric display on the top line of the LCD.

Enter the frequency step size, using the ten-keys followed by the **kHz** or **MHz** key to confirm the entry. Once the frequency step has been entered, the display step will automatically calculate the SPAN and display STEP and SPAN on the top line of the display.



Note: If you select a step size which is too large, the SDU5600 will default to 31.250kHz step with span of 10MHz... and will produce an error beep (if the beep facility is enabled). If you select a step size which is too small, the SDU5600 will default to 0.500kHz step with span of 0.160MHz... and will produce an error beep (if the beep facility is enabled).

Special key - CENTRE FREQ.

This hardware special key is a duplicate of the soft key **CENTRE FREQ.** and has identical action. Either key may be used to the same effect.

Effective frequency coverage of the companion receiver

The frequency spread (both sides of the centre frequency) must be contained within the frequency coverage of the companion receiver. If exceeded, correct monitoring will be impossible.

Display frequency bandwidth is obtained by the following formulae:-

In the spectrum analyser mode: $CF \pm (\text{Frequency span divided by } 2)$

In the step resolution mode: $CF \pm (\text{Display step} \times 160)$

Example of the automatic calculation of frequency span

In the above illustration, the frequency STEP is 25kHz, so the SPAN is calculated by the SDU5600 as:

$$25\text{kHz} \times 320 = 8\text{MHz}$$

where 320 is the horizontal x-axis resolution of the LCD.

5-4-3 Channel scope mode

Example of the screen is shown here, the parameters are:

Start frequency = 118.0MHz
 Step frequency = 25kHz
 End frequency = 122.00MHz
 Frequency span = 4MHz
 Marker frequency = 121.8MHz
 Receive marker = 119.7MHz

Unlike the spectrum analyser mode or step resolution mode there is no centre frequency (CF) in the channel scope mode.

Start frequency (Ch.START)

Press the **Ch.START** key to make the start frequency read-out display appear in reverse contrast. Enter a desired frequency using the ten-keys, which is the lowest of the frequency spread you wish to monitor (start frequency), followed by **ENT** to confirm.

Step frequency (Ch.STEP)

Press the **Ch.STEP** key to make the step frequency display red-out appear in reverse contrast. Enter the desired step frequency of your choice using the ten-keys followed by **ENT** to confirm.

End frequency (Ch.END)

Press the **Ch.END** key to make the end frequency display read-out appear in reverse contrast. Enter a frequency, using the ten-keys, which is the highest of the frequency spread you wish to monitor (end frequency), followed by **ENT** to confirm.

Receive frequency (RX.FREQ)

When the channel scope mode is activated, monitoring begins on the start frequency. Rotate the main dial of the SDU5600 to move the marker onto the signal of your interest, and press the **MK.F** key. The yellow receive marker moves to the nominated position and the companion receiver monitors the wanted frequency. As the main dial of the SDU5600 is rotated, the white marker moves and the yellow receive marker is left in position to signify the current active receive frequency. To select a new frequency to monitor, simply press the **MK.F** key.

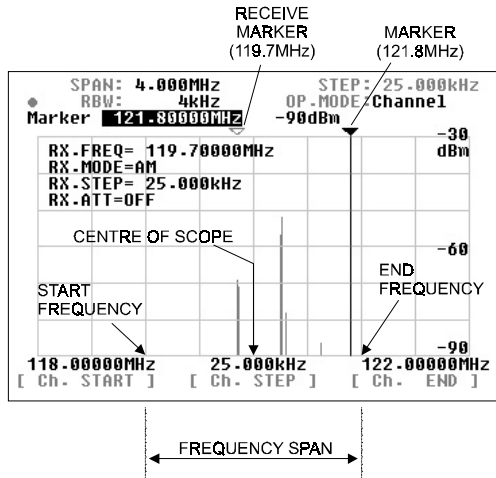

Note: The end frequency (Ch.END) is confined by the formulae:

$$(\text{Ch.START}) + [(\text{Ch.STEP}) \times 160]$$

or

$$(\text{Ch.START}) + 5\text{MHz}$$

For this reason, if you do not enter an END frequency, the SDU5600 will automatically select an appropriate end point.

Invalid entry for the end frequency will be alerted with a beep (if the feature is enabled), and the closest possible valid frequency will be automatically chosen by the SDU5600. Similarly, any invalid entry of frequency will be alerted with the beep (if the feature is enabled), and will be automatically adjusted to the nearest possible frequency by the SDU5600.

5-4-4 Common features shared by different monitoring modes

Input sensitivity (AMPLITUDE)

This feature refers to the setup of the input sensitivity level of the SDU5600 which is adjusted by the internal amplifier of the SDU5600. There are 4 different levels of input sensitivity between 0dBm and -30dBm in 10dB steps.

Press the **AMPLITUDE** special key to make the reference level display appear in reverse contrast. Enter the required sensitivity level via the ten-keys or main dial, followed by **ENT**.

For example, if -20dBm is required press **AMPLITUDE 2 MHz**. You can ignore trailing zeros '0' following 2 in this instance.

Any invalid entry will be alerted with the beep, and the nearest possible value will be automatically selected instead.

The resulting displayed signal wave on the LCD is affected by combinations of various factors such as input sensitivity of the SDU5600, attenuator position and AGC setting (where applicable) of the companion receiver. Higher input sensitivity does not always provide the best results. It is also possible to produce distorted signals due to saturation to / from the companion receiver, this may lead to a raised noise floor of the SDU5600 or spurs.

Significance of the input sensitivity (reference level)

The two plots shown here show the results from monitoring the same signal at 80.0MHz WFM but using different input sensitivity settings.

The plot on top was produced with the input sensitivity of -30dBm, the input sensitivity is too high, which results in unstable operation within the RF amplifier of the SDU5600. This has produced some ghost signals (images) separated at regular intervals.

The bottom plot was produced with the input sensitivity of -20dBm. Optimum results are obtained due to correctly selected input sensitivity.

It is important to select the input sensitivity most appropriately to ensure best results.

The AR5000 series receivers and RFU5600 feature AGC level adjustment, however AGC level cannot be adjusted remotely from the SDU5600.

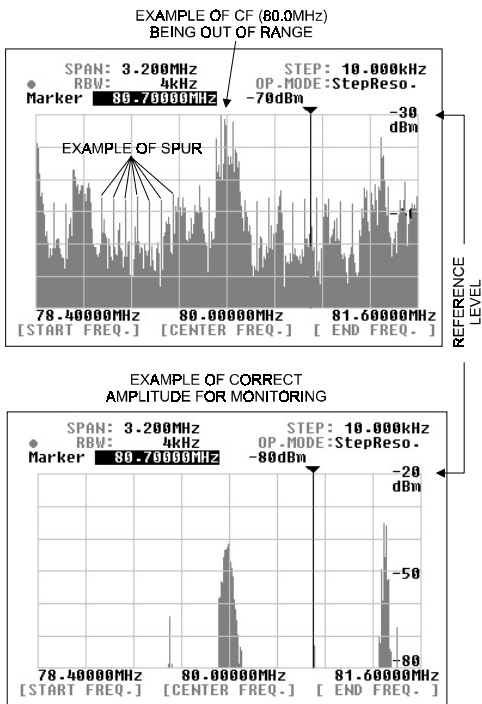

 Effective use of the attenuator of the companion receiver will be required to prevent saturation of received signal particularly when an external aerial is used.

Resolution band width (RBW)

The SDU5600 provides four selectable RBW bandwidths which are 4kHz, 32kHz, 64kHz and 128kHz.

Press the **RBW** key to make the RBW display appear in reverse contrast. Rotate the main dial to select the desired value followed by **MHz** or **kHz** to complete the selection sequence.

The two plots here show the results from monitoring the same signal (80MHz WFM) but using 4kHz and 128kHz RBW bandwidths respectively.

With the narrower RBW, the finer signal activity can be observed. With the wider RBW bandwidth the resolution becomes coarse but it can be more suited for signals with wide bandwidth such as FM broadcast signal.

The RBW should be chosen as appropriate for different monitoring requirements.

As the SDU5600 employs modern DSP/FFT techniques, there is no difference in screen update speed irrespective of which RBW has been selected. However, selection of RBW may affect the displayed signal strength.

When a signal is displayed which is much wider in bandwidth than the currently selected RBW filter, there will be some inaccuracy in the signal strength displayed. This is because the wider signal will lose some of its energy after passing through the narrower RBW filter. The same signal may produce a higher signal strength on the LCD display if it has passed through (more appropriately selected) wider RBW filter.

RBW = 4kHz

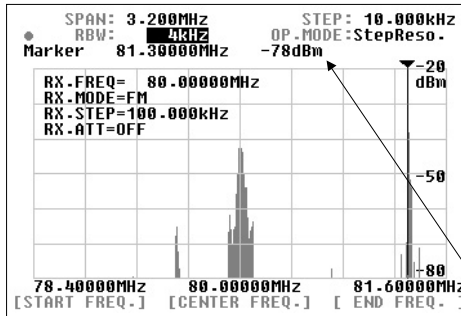

RBW = 128kHz

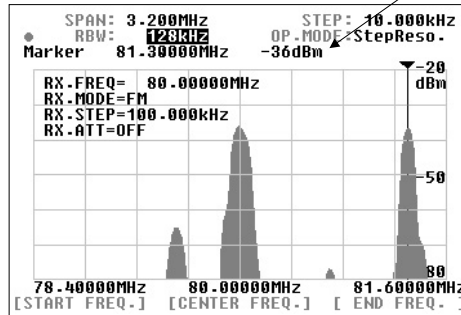

ILLUSTRATIONS SHOW THE DIFFERENCE IN HEIGHT OF THE DETECTED SIGNALS AND THEIR STRENGTH

5-5 Marker

The SDU5600 has a marker facility. The marker is often used to obtain the reading of the frequency of interest. In addition to the instantaneous reading, it provides the peak detection and continuous peak detection.

Press **FUNC + MK.F** to place the SDU5600 in to marker mode operation.

| | |
|---------------------------|---------------|
| Instantaneous reading | Marker |
| Peak detection | Peak |
| Continuous peak detection | C-Peak |

Instantaneous reading (Marker)

This feature is useful for many applications. The marker can be moved sideways by rotating the main dial.

The LCD displays the frequency and signal strength reading where the marker is positioned.

Peak detection (Peak)

This feature is used to detect the most powerful signal while sweeping the frequency spread.

Press the **PEAK** key, which in turn requests a trigger level, you need to specify what level is required. Enter the trigger level via the ten-keys. Only signals which are stronger than the trigger level you specified will then be subject to the peak detection.

The marker will be forced to the position of the strongest signal detected and end its sweep sequence.

The trigger level is selectable from -90dBm to 0dBm in 1dBm steps.

Entry is via the ten-keys and the sequence is confirmed by **ENT**

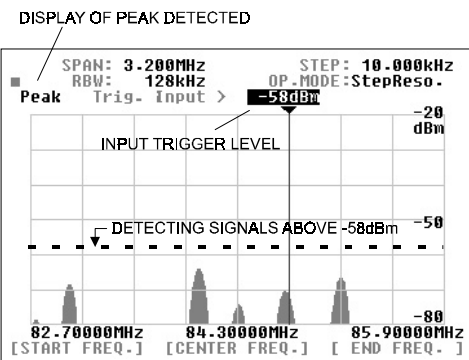
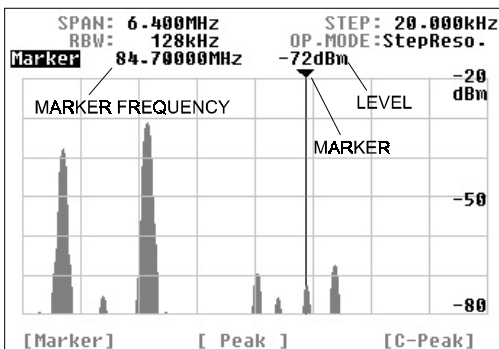
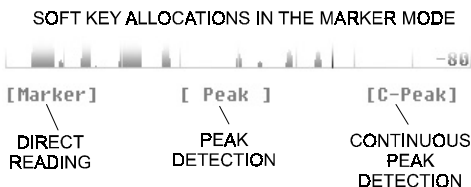

WHILE NO SIGNAL ABOVE THE TRIGGER LEVEL IS DETECTED [Trig. wait...] IS DISPLAYED

NO DOTTED LINE IS ACTUALLY DISPLAYED ON THE LCD, IT IS SHOWN HERE FOR ILLUSTRATIVE PURPOSES ONLY

Continuous peak detection (C-Peak)

This facility is designed to continue the peak signal detection process one sweep after another. Press the **C-Peak** key to activate the facility. There is no trigger level setup in the process.

To return to the instantaneous reading either from the peak detection mode or continuous peak detection mode press the **CLR** key... depending on the operating configurations a multiple press of **CLR** may be required.

DISPLAY OF CONTINUOUS PEAK DETECTION

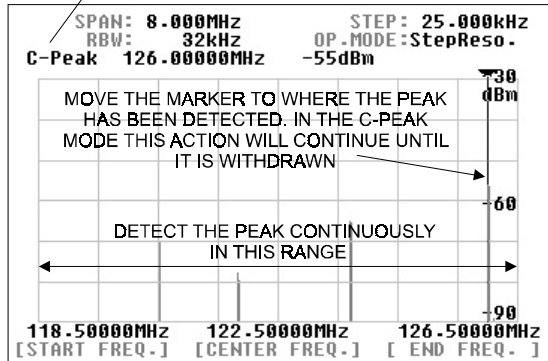

Marker receiver (MK.F)

This facility is designed to force the companion receiver to receive the signal where the marker is positioned on the screen. There are slight variations in functionality monitoring mode-by-mode.

MK-CF

In the *spectrum analyser mode* and *step resolution mode* the key it works as **MK > CF** (marker to centre frequency) which forces the marker frequency to become the centre frequency.

MK-RF

In the channel scope mode the key works as **MK > RF** (marker to receive frequency) where the companion receiver will receive the marker frequency. The start frequency, channel step and end frequency are unaffected, so will continue monitoring in the channel scope mode as configured.

MK.F **MK.F key functions**

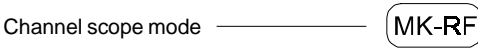
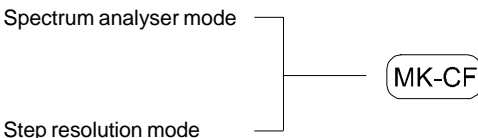

When the continuous peak detection is being used in the channel scope mode, the marker will automatically move to the strongest signal detected in the process of sweep. Press the **MK.F** key to automatically tune the companion receiver to the strongest signal instantly, so that you can monitor the active frequency.

5-6 Calculation facility

Maximum value hold (MAX)

Press the **FUNC +7** keys to activate this facility, the legend **MAX** will be displayed on the graticule section of the LCD.

Press the **CLR** key to exit from max hold.

Without the MAX feature being used, each new sweep across the frequency spread will renew the signal activities over and over. However, with the MAX feature in use each sweep will be retained as data is built-up until the process ends. This is particularly useful to detect intermittent signals which come and go over a period of time.

DISPLAY OF MAX VALUE HOLD

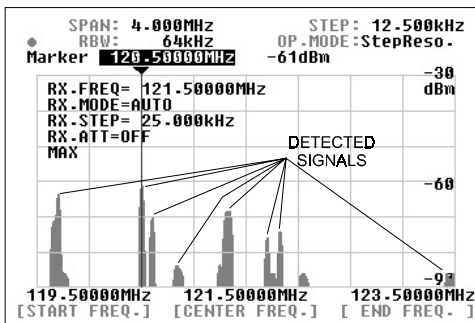

THIS EXAMPLE SHOWS THE RESULT HAVING MONITORED THE VHF AIRBAND WITH THE MAX HOLD MODE. IT IS POSSIBLE TO ANALYZE THE DETECTED SIGNALS AFTER THE SWEEP HAS FINISHED

Averaged value (AVR)

Press the **FUNC + 8** keys to activate this facility, the legend **AVR** will be displayed on the graticule section of the LCD.

You are required to enter a sampling cycle between 2 and 31 to produce averaged results.

Press the **CLR** key to exit.

This facility is designed to provide the plot pattern which has been obtained by averaging the detected signals repeated over the number of times in the sampling cycle. This facility enables the SDU5600 to produce a stable signal pattern even if each signal is fluctuating in signal strength.

DISPLAY OF AVR AND ENTRY OF 'N'

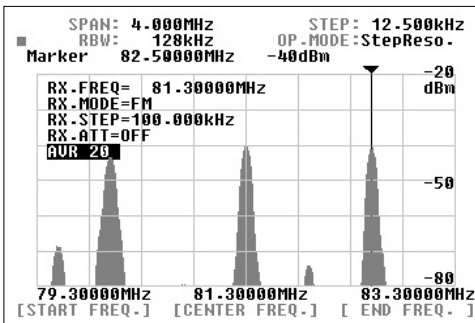

Median (MED)

Press the **FUNC + 9** keys to activate this facility, the legend **MED** will be displayed on the graticule section of the LCD. The plot is designed to provide the signal pattern based over a sampling cycle of between 2 and 4 and is useful to plot impulse noise. The sampling cycle can be entered via the ten-keys followed by **ENT** Press the **CLR** to exit.

Theory of median filter

| | |
|--------------|---------------------------------------|
| AVR | N = 31 |
| FIRST SWEEP | PLOT AS THE SWEEP PROGRESSES |
| SECOND SWEEP | (1 + 2) / 2 = A |
| THIRD SWEEP | (1 + 2 + 3) / 3 = B |
| : | : |
| 30TH SWEEP | (1 + 2 + 3 + 30) / 30 = A1 |
| 31ST SWEEP | (1 + 2 + 3 + 30 + 31) / 31 = B1 |
| 32ND SWEEP | ((B1 X 31 / 32) + 32) / 32 |

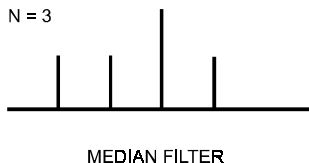

5-7 Waterfall display facility

The SDU5600 is equipped with a waterfall facility which can display the variation of signal strengths in conjunction with the time lapsed (as sweeps progress). Sixteen different colours are employed dependant on signal strength, in the shape of a waterfall.

Press the **FUNC + ●** to start the waterfall display. The bottom half of the screen will be allocated to the waterfall display and will build-up with time.

The waterfall display continues to operate being unaffected by change of the monitoring mode, calculation mode, the RBW, centre frequency, frequency span, start frequency and end frequency.

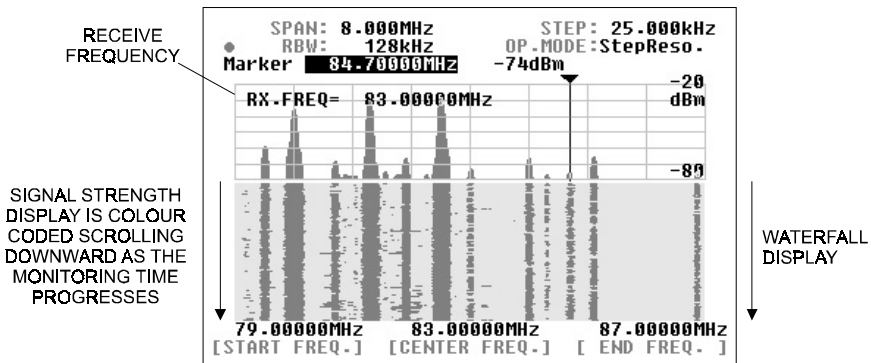

To exit from the waterfall display, repeat the key sequence **FUNC + ●**

Signal strength is represented by sixteen different colours, corresponding to the height of each signal in the vertical scale. Therefore the colour will vary when the input sensitivity (AMPLITUDE) has been altered in the course of monitoring.

Waterfall colour corresponds to the vertical height

Red
Yellow
Green
Light blue
Blue



While the waterfall display is in operation, the only parameter of the companion receiver which can be altered is the receive frequency.

To exit from the waterfall display, repeat the key sequence **FUNC + ●** or press **CLR**

5-8 On/off of the displayed information

The companion receiver parameters are usually displayed on the left side of the LCD graticule. The key sequence **FUNC + 5** (DISP) will toggle the display of the companion receiver's parameter on / off.



When the calculation mode is in use, the calculation data will be turned on or off by the same key-in sequence.

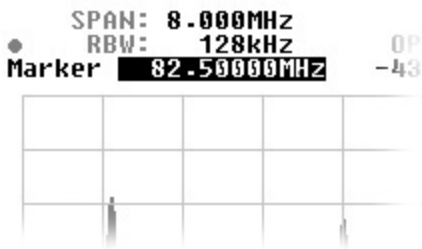

By effective use of this facility, you can view the signal activities easier on the much less cluttered display area.

5-9 Beep alert

To toggle the keypad confirmation beep on / off, use the key sequence **FUNC + 6** (BEEP).

5-10 Factory default/reset

If you wish to revert the SDU5600 to default status, power-on the SDU5600 via the main power switch while holding-in the **3** and **6** keys together until the opening message **EEPROM initialized** is displayed.

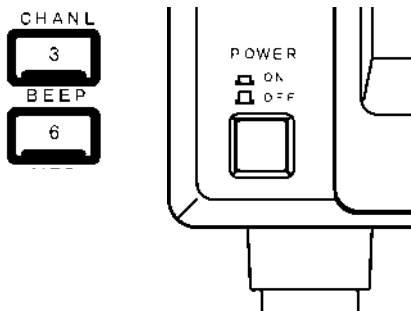

6. Operating the SDU5600

This section will provide examples of operating the SDU5600 using the AR5000A+3 as companion receiver. Refer to pages 10 to 12 of this manual for connection to the receiver.

6-1 Operate the SDU5600 with the AR5000A+3.

Turn the SDU5600 on, which is followed by the opening message to confirm for readiness.

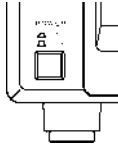

Access the configuration menu by pressing the **FUNC + 4** to select the companion receiver.

Press the **RX** key, which displays the current companion radio type above the key on the LCD in reverse contrast. Select the AR5000 (in this example) via the main dial followed by **ENT**. The communication between the two should be correctly established so that you can start monitoring.

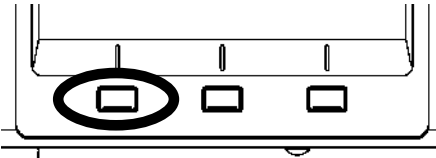

At this stage the SDU5600 is operating in the spectrum analyser mode with the centre frequency (CF) corresponding to the receive frequency of the AR5000A+3. The frequency span (visible bandwidth) is 10MHz.

Setup of the companion receiver

Continue to operate the AR5000A+3 via the SDU5600 referring to the following example:

```
RX.FREQ. = 80.00000MHz
RX.MODE  = AUTO
RX.STEP  = 100.000kHz
RX.ATT   = OFF
```

The SDU5600 can remotely operate the following functions of the companion receiver.

- ★ Receive frequency
- ★ Receive mode
- ★ Frequency step
- ★ Attenuator on/off

Other functions such as the antenna switching are not possible.

Access the configuration menu

FUNC **4**

Selection of the companion receiver soft key

RX

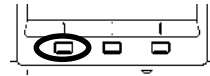

Rotate the main dial to select the companion receiver

Confirm the selection of the companion receiver

kHz or **MHz**

Enter the centre frequency CF (80MHz)

8 **0** **MHz**

Press the **MODE** key to access the receive mode menu. Select the receive mode by rotating the main dial to **AUTO** followed by **MHz**

MODE **MHz**

In this example, the **AUTO** mode will select a receive mode of **FM** and frequency step of **100kHz**.

To toggle the attenuator on/off, press the attenuator key

ATT

6-2 Monitor the VHF FM band in the spectrum analyser mode

Continue to operate the SDU5600 from section 6-1 where the SDU5600 / AR5000A+3 has been set in the spectrum monitoring mode.

The example to the right is the actual result which was obtained after monitoring the signal spectrum at the AOR headquarters in Tokyo. It indicates the input signal being saturated, resulting in some weak ghost signals appearing at regular intervals close to the floor level of the spectrum trace.

Adjust the input sensitivity (from -30 to -20)

Press the **AMPLITUDE** key to display the reference level on the LCD, which appears in reverse contrast (-30dBm). Rotate the main dial to select -20dBm which lowers the input sensitivity by 10dB followed by **ENT** (MHz or kHz)



Adjust the resolution bandwidth (from 4kHz to 128kHz)

Press the **RBW** key to display the resolution bandwidth value on the LCD, which appears in reverse contrast (4kHz). Rotate the main dial to select 128kHz followed by **ENT** (MHz or kHz)



The example on the right now shows the same result with the RBW set to 128kHz, this bandwidth is far more suitable for monitoring FM broadcast signals with wider band occupancy.

Refer to page 23, section 5-4-1 should you wish to operate the CF, frequency span, etc in the spectrum analyser mode.

EXAMPLE PRIOR TO THE INPUT SENSITIVITY BEING ALTERED

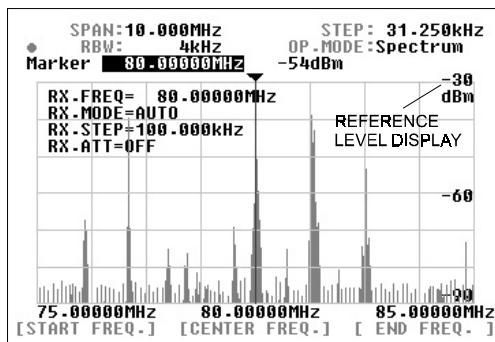

EXAMPLE AFTER THE INPUT SENSITIVITY HAS BEEN ALTERED

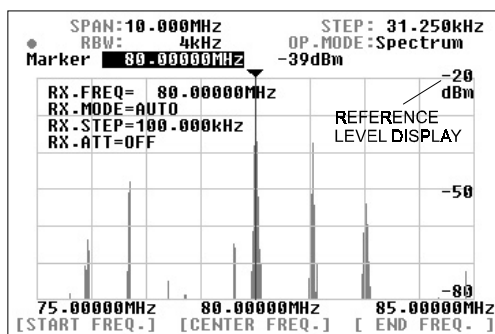

EXAMPLE OF FREQUENCY RESOLUTION BEING ALTERED

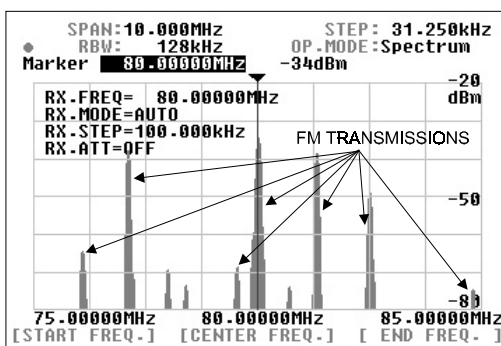

6-3 Monitor the FM broadcast band in the step resolution mode

The following information explains how to change the monitoring mode from the default of spectrum analyser mode to the step resolution mode.

Press the **FUNC + 2 (STEP)**, the SDU5600 will shift to Step Resolution mode with the legend **StepReso.** appearing on the LCD. The display step will be unchanged at this stage.

FUNC 2

You may wish to change the display step to a 25kHz in order to make the task of monitoring easier. Press the **SPAN/STEP** key, which results in the step display appearing in reverse contrast on the LCD. Type in the required step size via the ten-keys, in this example **2 5** followed by **kHz**

SPAN/STEP
 2 5 kHz



Rotate the main dial to move the marker sideways. It should be immediately noticeable that the frequencies on active signals can be found in 25kHz steps, which is much more suitable for monitoring channelised bands such as FM broadcast.

**In the step resolution mode the rule is:
 1 displayed dot = 1 displayed step**

The horizontal x-axis of the SDU5600 provides 320 dots.

Therefore in the above example, one displayed dot represents one 25kHz increment. The step resolution mode provides a kind of operating convenience where the operator can almost instinctively view activity on the band and how the activity is distributed.

The example on the right shows the signal activities observed at the AOR headquarters in Tokyo over the FM broadcast band in the step resolution mode. Refer to page 24, section 5-4-2 should you wish to operate the CF, display step, etc.

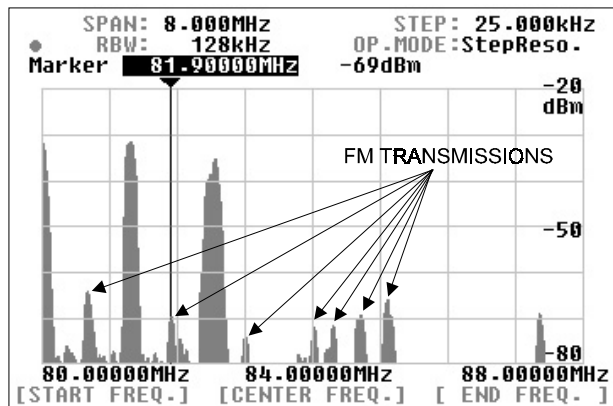

6-4 Monitor the VHF air band in the channel scope mode.

The VHF airband is allocated over the wide frequency band, It is therefore impossible to display the entire VHF airband on the SDU5600 at once. The channel scope mode however provides a very convenient method of monitoring the channelised frequency band through the use of both the marker and receive marker. Using this method, you can split the airband into small sections for quick inspection.

Change of the monitoring mode

To change to Channel Scope mode press **FUNC + 3** (CHANL). The LCD legend **OP.MODE:Channel** confirms that channel scope mode has been engaged.



The LCD legend above **[Ch.START]** will display a frequency in revers contrast, this is inviting you to key in a new start frequency via the ten-keys.

Enter a start frequency of 118MHz, if you make a mistake, press **CLR** to return to the start entry position.



The LCD entry point will move to **[Ch.STEP]**, enter a step frequency of 25kHz

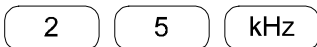

The LCD entry point will move to **[Ch. END]**, enter an end frequency of 122MHz



Note, the end frequency is always restricted under the rules:

$$(CH.START) + [(CH.STEP) \times 160]$$

and

$$(CH.START) + 5MHz$$

Any incorrect entry of the end frequency will be alerted with the beep, and it will be automatically corrected to the nearest possible frequency.

Upon the successful entry of the end frequency the companion receiver will commence receiving on the start frequency. Change the receive mode to AM for air band if required (or use AUTO mode), use the **MODE** key, main dial or SDU5600 and **MHz** key.

Rotate the main dial, which moves the marker sideways. The **receive marker** legend appears (yellow outline triangle on the LCD) to indicate the frequency which the companion receiver is actually receiving.

Press the **MK.F** key to move the receive marker to the marker position, this will move the companion receive to the new frequency where monitoring will continue.

Each time you press the **MK.F** key, the companion receiver will shift to the marker position, as you move the marker by rotating the SDU5600 main dial, two markers will be displayed on the LCD. You can change the parameters at any time by pressing the corresponding soft key under the LCD.

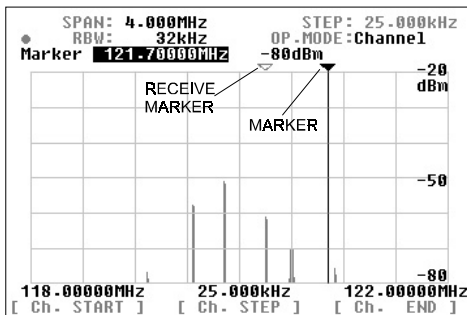

6-5 Suitable applications of each monitoring mode

A summary of the three monitoring modes and suitable applications is given here:

Spectrum analyser mode

This mode is the DEFAULT and most common monitoring mode among the three. It is suited to the monitoring of permanent or intermittent signals or noise. The CF (centre frequency) and SPAN (visible bandwidth) are the main criteria to be specified.

Step resolution mode

This mode is suited best to monitor signals which are allocated with certain intervals over the band spectrum. The STEP is the criteria to be specified in place of the SPAN, so that one dot is equal to one step on the display.

Channel scope mode

This mode is best suited to monitor known channelised frequency spectrums such as VHF airband and FM sections or broadcast and ham radio bands. The start frequency, end frequency and step have to be specified. There is no concept of CF applied to this mode. It is most convenient to follow and listen to the various signals by using both marker and receive markers.

7. Useful Information

The SDU5600 has been designed to operate with a wide-band companion receiver such as the AR5000A. Therefore, there are some differences in operating characteristics with the unit when compared with the spectrum analysers which are designed for more general testing / measuring applications. It is advisable that you take into account the following information while making yourself familiar with the SDU5600.

Signal strength

The signal strength which the SDU5600 indicates is measured at the RF input of the SDU (not the signal strength of the companion receiver at the antenna terminal). If the radio provides a gain / loss from the aerial input to IF output, the calibration of displayed signal strength will be affected. Most receivers provide a POSITIVE gain of +10dB or so. The receivers AGC and attenuator will also affect results.

Frequency characteristics of the companion receiver

The SDU5600 operates with a wide span of frequency (up to 10MHz band span). It must be noted that the companion receiver's RF circuit and / or IF filter configuration may affect the spectrum monitoring with some interference being observed. In particular, when the wider band span has been selected such as a 10MHz, the far ends of the band edges are most affected depending on characteristics of the receiver in use. The AR5000A is usable over 10MHz bandwidth, as is the AR3000A, however the output level of the AR8600/ MK2 drops beyond 4MHz or so.

Excessive input from the receiver

While receiving strong signals (e.g. broadcast station) with an external aerial connected to the companion receiver, the noise floor may appear to be incorrectly lifted due to distortion from the receiver. Use of the attenuator of the receiver may help reduce these phenomena... however, generally speaking the front end selectivity of the companion receiver is beneficial compared to a directly fed spectrum analyser.

Selection of RBW

When monitoring the signals of broader bandwidth with the narrower RBW selected, the displayed signal strength may appear reduced (less accurate) due to the fact that only part of the energy from the broader bandwidth can pass through the narrower sampling filter, resulting in loss of signal strength to some extent. When monitoring wider signals (such as FM broadcast), use a wider RBW such as 128kHz.

AGC action of the companion receiver

It must be noted that the AGC action of the companion receiver may affect the spectrum monitoring by the SDU5600. It may be observed that the overall signal strength has dropped when abrupt changes in receiving conditions have occurred (for example, when quickly tuning from a weak signal to a strong signal). This is because the input from the receiver's IF is significantly reduced by AGC action. Switching the companion receivers AGC off may eliminate this effect but the reception will become unstable and distorted with AGC off.

Image signal

Occasionally false signals (spurious image signal) can be spotted on the display, sometimes moving at random, sometimes to the opposite direction while monitoring the spectrum. This is due to the image signals which are generated by characteristics of the companion receivers superheterodyne circuit design or intermodulation products, ALL receivers will present this affect to some degree.

With the SDU5600 operating at its widest sweep range (10MHz) when coupled to an **AR5000A**, an unwanted spurious signal can be observed approximately 4.8MHz away from the centre frequency (moves slightly with AR5000A frequency). This is present at all frequencies although it will jump to the other side of the screen when the AR5000 is tuned above 1.4GHz.

The spuri appears to be leakage of the 2nd local oscillator DDS signal at 5.8MHz to 6.7MHz (hence when viewed from the IF frequency of 10.7MHz becomes 4.9 to 4.0MHz away). This is not a problem during normal receive with the AR5000A as the 10.7MHz filter removes any signal but is present at the IF output taken before the filter. It is also not a problem if the sweep width on the SDU5600 is reduced slightly.

To address this, select a bandwidth of about 9.8MHz rather than 10MHz, so the spuri drops off the edge of the display. The spuri is usually in the area of -70dBm to -60dBm.

The **AR8600/MK2** produces a 455kHz image, its a compromise of design and has to be worked around.

RF earth

Of course all electrical equipment produces some noise, especially where large displays are involved. Connecting a good RF earth to the equipment can help with general low level spuri... the AC adapter is not earthed, avoid earth loops.

Minimum frequency span

The SDU5600 has a minimum frequency span of 160kHz (0.160MHz). It is not possible to set the frequency span narrower than 160kHz.

8. SDU5600 Command List

The SDU5600 can be operated via PC using the RS232 port.

8-1 Communication parameter and connecting lead

The SDU5600 and a PC should be connected using a straight cable between the [PC I/F] socket and the serial port of the PC. The SDU5600 port is MALE, so the PC lead must have a female connector or a gender changer will have to be employed.

Communications parameters of the SDU5600

| | |
|--------------|---------|
| Baud rate | 9600bps |
| Data length | 8 bit |
| Parity | None |
| Stop bit | 2 bit |
| Flow control | RTS/CTS |

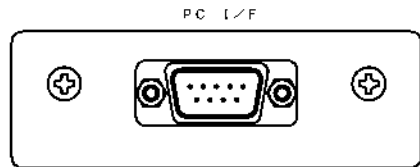

8-2 Delimiter

A brief description of delimiter and response format is given here.

Delimiter

Each command from the PC to SDU5600 is defined by:

<CR> 0x0d in 16-bit form

or

<CR><LF> 0x0d,0x0a in hexadecimal format

Note: <LF> will be ignored

Response when the command has been correct:

<SP><CR><LF> 0x20,0x0d,0x0a in hexadecimal format

Response when the command has been incorrect:

?<CR><LF> 0x3f,0x0d,0x0a in hexadecimal format

Response to the read command:

Following the output of the parameter, the correct response should read

<SP><CR><LF> 0x20,0x0d,0x0a in hexadecimal format

8-3 Basic format of the command

Each command to be sent to the SDU5600 consists of 4 letters (upper case) in ASCII code with appropriate parameters followed by <CR><LF>.

Each letter represents the following:

| | |
|---------------------------------|--|
| (1) First letter | Either W for write or R for read |
| (2) Second letter | Line of command such as S for spectrum analysis, V for visual set-up, U for user interface and I for information |
| (3 & 4) Third and Fourth letter | Categories of each line of command |

8-4 RS232 command list

Commands are divided into four categories:

S = Spectrum analysis

V = Visual command

U = User Interface

I = Information

Microsoft Windows® Hyper Terminal® may be used to control the SDU5600 or you may write your own software.

An example of command format is given here:

RSCF<CR> Response: SCF79.5<SP><CR><LF>

In this example, the centre frequency is read.

Command = Read

Category = Spectrum analysis

Type of command (abbreviation) = CF

Parameter (variable) = Not used in this example

Example of input = RSCF<CR> Response from SDU5600 = SCF79.5<SP><CR><LF>

A correct WRITE command results in the action being carried out and <CR><CR><LF> being returned. An incorrect command results in a question mark "?" followed by <CR><LF> being returned.

Spectrum analysis

Command : **WSCF** Function : **SET CENTER FREQUENCY** Command category: **WRITE**

Parameter : Min- Max (in MHz)

Example : WSCF79.5<CR><LF> Response: if correct: <SP><CR><LF>
if incorrect: ?<CR><LF>

Remarks: Frequency entry for out of receive range will be respond by ?<CR><LF>, and the command will be ignored.

Command : **RSCF** Function : **READ CENTER FREQUENCY** Command category: **READ**

Parameter : **N/A**

Example : RSC<CR><LF> Response: SCF79.5<SP><CR><LF>

Remarks: Frequency is displayed in MHz.

Command : **WSSP** Function : **SET SPAN FREQUENCY** Command category: **WRITE**

Parameter : **0.16 ~ 10 (MHz)**

Example : WSSP0.62<CR><LF> Response: if correct: <SP><CR><LF>
if incorrect: ?<CR><LF>

Remarks: Data entry for out of range will be respond by ?<CR><LF>, and the command will be ignored.

Command : **RSSP** Function : **READ SPAN FREQUENCY** Command category: **READ**

Parameter : **N/A**

Example : RSSP<CR><LF> Response: SSP0.62<SP><CR><LF>

Remarks: Frequency is displayed in MHz.

Command : **WSBW** Function : **SET RBW** Command category: **WRITE**

Parameter : **1 ~ 4**

Example : WSBW1<CR><LF> Response: if correct: <SP><CR><LF>
if incorrect: ?<CR><LF>

Remarks: Parameter vs. RBW is as follows: 1 = 4 KHz, 2 = 32 KHz, 3 = 64 KHz, 4 = 128 KHz
Data entry for out of range will be respond by ?<CR><LF>, and the command will be ignored.

Command : **RSBW** Function : **READ RBW** Command category: **READ**

Parameter : **N/A**

Example : RSBW<CR><LF> Response: SBW4<SP><CR><LF>

Remarks: Parameter vs. RBW is as follows: 1 = 4 KHz, 2 = 32 KHz, 3 = 64 KHz, 4 = 128 KHz.

Command : **WSGN** Function : **SET AMPLITUDE** Command category: **WRITE**

Parameter : **-30 ~ 0**

Example : WSGN-30<CR><LF> Response: if correct: <SP><CR><LF>
if incorrect: ?<CR><LF>

Remarks: Amplitude is set in 10 incremental. Data entry for out of range will be respond by ?<CR><LF>, and the command will be ignored.

Command : **WSCM** Function : **SET CURSOR** Command category: **WRITE**

Parameter : **1 ~ 3**

Example : WSCM3<CR><LF> Response: if correct: <SP><CR><LF>
if incorrect: ?<CR><LF>

Remarks: Parameter : **1 = MARKER, 2 = PEAK, 3 = C-PEAK** To use this command, you need to set the trigger level by using the WSTL command. Data entry for out of range will be respond by ?<CR><LF>, and the command will be ignored.

Command : **RSCM** Function : **READ CURSOR** Command category: **READ**

Parameter : **N/A**

Example : RSCM<CR><LF> Response: SCM1<SP><CR><LF>

Remarks: Parameter : **1 = MARKER, 2 = PEAK, 3 = C-PEAK**

Section 8-4

Command : **WSTL** Function : **SET PEAK TRIGGER LEVEL** Command category: **WRITE**

Parameter : **-90 ~ 0**

Example : WSTL-80<CR><LF> Response: if correct: <SP><CR><LF>
if incorrect: ?<CR><LF>

Remarks: Data entry for out of range will be respond by ?<CR><LF>, and the command will be ignored.

Command : **RSTL** Function : **READ PEAK TRIGGER LEVEL** Command category: **READ**

Parameter : **N/A**

Example : RSTL<CR><LF> Response: STL-80<SP><CR><LF>

Remarks: Read the trigger level in the Peak mode.

Command : **WSDM** Function : **SET DATA MODE** Command category: **WRITE**

Parameter : **1 ~ 4**

Example : WSDM2<CR><LF> Response: if correct: <SP><CR><LF>
if incorrect: ?<CR><LF>

Remarks: Parameter: **1 = NORMAL, 2 = AVR, 3 = MAX, 4 = MED** If AVR or MED is selected, you need to set the WSME command before executing the command. Data entry for out of range will respond by ?<CR><LF>, and the command will be ignored.

Command : **RSDM** Function : **READ DATA MODE** Command category: **READ**

Parameter : **N/A**

Example : RSDM<CR><LF> Response: SDM3<SP><CR><LF>

Remarks: Parameter: **1 = NORMAL, 2 = AVR, 3 = MAX, 4 = MED**

Command : **WSAV** Function : **SET AVR SAMPLING** Command category: **WRITE**

Parameter : **2 ~ 31**

Example : WSAV10<CR><LF> Response: if correct: <SP><CR><LF>
if incorrect: ?<CR><LF>

Remarks: Set AVR sampling and set the DATA mode to AVR. Data entry for out of range will respond by ?<CR><LF>, and the command will be ignored.

Command : **RSVA** Function : **READ AVR SAMPLING** Command category: **READ**

Parameter : **N/A**

Example : RSVA<CR><LF> Response: SAV10<SP><CR><LF>

Command : **WSME** Function : **SET MED SAMPLING** Command category: **WRITE**

Parameter : **2 ~ 4**

Example : WSME4<CR><LF> Response: if correct: <SP><CR><LF>
if incorrect: ?<CR><LF>

Remarks: Set MED sampling and set the DATA mode to MED. Data entry for out of range will respond by ?<CR><LF>, and the command will be ignored.

Command : **RSME** Function : **READ MED SAMPLING** Command category: **READ**

Parameter : **N/A**

Example : RSMED<CR><LF> Response: SMED4<SP><CR><LF>

Visual command

Command : **WVPM** Function : **SET PLOT MODE** Command category: **WRITE**

Parameter : **1 ~ 2**

Example : WVPM2<CR><LF> Response: if correct: <SP><CR><LF>
if incorrect: ?<CR><LF>

Remarks: Parameter: **1 = PAINT, 2 = OUTLINE** Data entry for out of range will be respond by ?<CR><LF>, and the command will be ignored.

Command : **RVPM** Function : **READ PLOT MODE** Command category: **READ**

Parameter : **N/A**

Example : RVPM<CR><LF> Response: VPM1<SP><CR><LF>

Remarks: Parameter: **1 = PAINT, 2 = OUTLINE**

Command : **WVDD** Function : **SET F-DIR** Command category: **WRITE**

Parameter : **1 ~ 2**

Example : WVDD2<CR><LF> Response: if correct: <SP><CR><LF>
if incorrect: ?<CR><LF>

Remarks: Parameter: **1 = NORMAL, 2 = REVERSE** Data entry for out of range will be respond by ?<CR><LF>, and the command will be ignored. This command is available only when the receiver is selected either Other(10M) or Other (45M).

Command : **RVDD** Function : **READ F-DIR** Command category: **READ**

Parameter : **N/A**

Example : RVDD<CR><LF> Response: VDD1<SP><CR><LF>

Remarks: Parameter: **1 = NORMAL, 2 = REVERSE**

Command : **WVWF** Function : **SET WATERFALL FUNCTION** Command category: **WRITE**

Parameter : **1 ~ 2**

Example : WVWF2<CR><LF> Response: if correct: <SP><CR><LF>
if incorrect: ?<CR><LF>

Remarks: Parameter: **1 = NORMAL, 2 = WATERFALL** Data entry for out of range will be respond by ?<CR><LF>, and the command will be ignored

Command : **RVWF** Function : **READ WATERFALL FUNCTION** Command category: **READ**

Parameter : **N/A**

Example : RVWF<CR><LF> Response: VWF2<SP><CR><LF>

Remarks: Parameter: **1 = NORMAL, 2 = WATERFALL**

Command : **RVIM** Function : **READ VISUAL IMAGE** Command category: **READ**

Parameter : **N/A**

Example : RVIM<CR><LF> Response: *see remarks*

Remarks: Due to the huge volume of image data, while this command is executed the communication speed will be changed to 115200bps. After data read is completed, the data speed will return to 9600 bps. A specific example of the response cannot be presented here due to its nature.

User interface

Command : **WUMD** Function : **SET RECEIVER MODE** Command category: **WRITE**

Parameter : **1 ~ 15**

Example : WUMD1<CR><LF> Response: if correct: <SP><CR><LF>
if incorrect: ?<CR><LF>

Remarks: Parameter: **1 = WFM, 2 = NFM, 3 = SFM, 4 = WAM, 5 = AM, 6 = NAM, 7 = LSB, 8 = USB, 9 = CW, 10 = AUTO, 11 = AMW, 12 = FM, 13 = FMN, 14 AMN, 15 = CWN**

Data entry for out of range or any mode that is not supported by the associated receiver will respond by ?<CR><LF>, and the command will be ignored

Command : **RUMD** Function : **READ RECEIVER MODE** Command category: **READ**

Parameter : **N/A**

Example : RUMD<CR><LF> Response: UMD1<SP><CR><LF>

Remarks: Parameter: **1 = WFM, 2 = NFM, 3 = SFM, 4 = WAM, 5 = AM, 6 = NAM, 7 = LSB, 8 = USB, 9 = CW, 10 = AUTO, 11 = AMW, 12 = FM, 13 = FMN, 14 AMN, 15 = CWN**

Command : **WUAT** Function : **SET ATT** Command category: **WRITE**

Parameter : **1 ~ 2**

Example : WUAT2<CR><LF> Response: if correct: <SP><CR><LF>
if incorrect: ?<CR><LF>

Remarks: Parameter: **1 = ON, 2 = OFF** Data entry for out of range or the attenuator function is not supported by the associated receiver, the SDU5600 will respond by ?<CR><LF>, and the command will be ignored

Command : **RUAT** Function : **READ ATT MODE** Command category: **READ**

Parameter : **N/A**

Example : RUAT<CR><LF> Response: UAT2<SP><CR><LF>

Remarks: Parameter: **1 = ON, 2 = OFF**

Command : **WUST** Function : **SET STEP FREQ.** Command category: **WRITE**

Parameter : **Size in KHz**

Example : WUST12.5<CR><LF> Response: if correct: <SP><CR><LF>
if incorrect: ?<CR><LF>

Remarks: Data entry for out of range or if the input freq. step is not supported by the associated receiver, the SDU5600 will respond by ?<CR><LF>, and the command will be ignored

Command : **RUST** Function : **READ STEP FREQ.** Command category: **READ**

Parameter : **N/A**

Example : RUST<CR><LF> Response: UST12.5<SP><CR><LF>

Remarks: Size in KHz

Command : **WURX** Function : **SELECT RECEIVER** Command category: **WRITE**

Parameter : **1 ~ 10**

Example : WURX3<CR><LF> Response: if correct: <SP><CR><LF>
if incorrect: ?<CR><LF>

Remarks: Parameter: **1 = Other (10M), 2 = Other (45M), 3 = AR5000, 4 = AR3000A, 5 = AR8600 (10M), 6 = AR8600 (45M), 7 = AR8200, 8 = AR-ONE, 9 = IC-R8500, 10 = IC-R7100, 11 = RFU5600** Data entry for out of range will respond by ?<CR><LF>, and the command will be ignored.

Command : **RURX** Function : **READ RECEIVER TYPE** Command category: **READ**

Parameter : **N/A**

Example : RURX<CR><LF> Response: URX3<SP><CR><LF>

Remarks: Parameter: **1 = Other (10M), 2 = Other (45M), 3 = AR5000, 4 = AR3000A, 5 = AR8600 (10M), 6 = AR8600 (45M), 7 = AR8200, 8 = AR-ONE, 9 = IC-R8500, 10 = IC-R7100, 11 = RFU5600**

Command : **WUMC** Function : **SET MARKER FREQ. AS RECEIVE FREQ.**

Command category: **WRITE**

Parameter : **N/A**

Example : WUMC<CR><LF> Response: if correct: <SP><CR><LF>
if incorrect: ?<CR><LF>

Remarks: This command is not available for the Other (10M) or Other (45M) receiver.

Command : **WUDS** Function : **MOVE MARKER POSITION** Command category: **WRITE**

Parameter : **1 ~ 2**

Example : WUDS2<CR><LF> Response: if correct: <SP><CR><LF>
if incorrect: ?<CR><LF>

Remarks: Parameter: **1 = 1 step left, 2 = 1 step right** Data entry for out of range will respond by ?<CR><LF>, and the command will be ignored.

Command : **WUOM** Function : **SET MONITOR MODE** Command category: **WRITE**

Parameter : **1 ~ 3**

Example : WUOM1<CR><LF> Response: if correct: <SP><CR><LF>
if incorrect: ?<CR><LF>

Remarks: Parameter: **1 = Spectrum analyzer mode, 2 = StepReso. mode, 3 = Channel mode**
Data entry for out of range will respond by ?<CR><LF>, and the command will be ignored.

Command : **RUOM** Function : **READ MONITOR MODE** Command category: **READ**

Parameter : **N/A**

Example : RUOM<CR><LF> Response: UOM1<SP><CR><LF>

Remarks: Parameter: **1 = Spectrum analyzer mode, 2 = StepReso. mode, 3 = Channel mode**

Command : **WUCS** Function : **PROGRAM CHANNEL MODE** Command category: **WRITE**

Parameter : 3 parameter entry

Example : WUCS 79.5 10 81.1<CR><LF> Response: if correct: <SP><CR><LF>
if incorrect: ?<CR><LF>

Remarks: Enter START freq. and END freq. in MHz, and STEP freq. in KHz. Enter the <SP> (Space) between each parameter. Data entry for out of range will respond by ?<CR><LF>, and the command will be ignored.

Command : **RUCS** Function : **READ CHANNEL MODE** Command category: **READ**

Parameter : **N/A**

Example : RUCS<CR><LF> Response: USCS 79.5 10 81.1<SP><CR><LF>

Remarks: Respond START freq. and END freq. in MHz, and STEP freq. in KHz. There is space between each parameter.

Command : **WUBP** Function : **SET BEEP ON/OFF** Command category: **WRITE**

Parameter : **1 ~ 2**

Example : WUBP1<CR><LF> Response: if correct: <SP><CR><LF>
if incorrect: ?<CR><LF>

Remarks: Parameter: **1 = BEEP ON, 2 = BEEP OFF**

Command : **RUBP** Function : **READ BEEP ON/OFF** Command category: **READ**

Parameter : **N/A**

Example : RUBP<CR><LF> Response: UBP1<SP><CR><LF>

Remarks: Parameter: **1 = BEEP ON, 2 = BEEP OFF**

Command : **WUBE** Function : **BEEP SETTING** Command category: **WRITE**

Parameter : **1 ~ 7**

Example : WUBE6<CR><LF> Response: if correct: <SP><CR><LF>
if incorrect: ?<CR><LF>

Remarks: Parameter: **1 = Emit “click” when key is pressed.**
2 = Emit “click” when key entry is ignored.
3 = Beep when correct entry is made.
4 = Beep when entry data is out of range.
5 = Beep when key entry is cancelled.
6 = Beep when On/Off parameter is set to ON.
7 = Beep when On/Off parameter is set to OFF.

Data entry for out of range will respond by ?<CR><LF>, and the command will be ignored.

General information

The following commands are used only during production of the SDU5600 to assist testing, and therefore, the commands are given for completeness only.

Command : **RVIM** Function : **READ VISUAL IMAGE** Command category: **READ**

Parameter : **N/A**

Example : RVIM<CR><LF> Response: *see remarks*

Remarks: When this command is sent to the SDU5600, it will respond as follows:

- 1 Respond to the command by sending <SP><CR><LF> to PC.
 2. Wait for approximately 400 mS.
 3. Change baud rate to 115200bps automatically.
 4. Output VIM (0x56, 0x49, 0x4d in hexadecimal).
 5. Output 1 dot (= 1 byte) of screen image data in 2 characters (in hexadecimal).
(Example) 0x4a data = 1A (2 byte) 0x31, 0x41 (in hexadecimal) 356 x 236 dot
(= 168032 characters)
 6. Output X (0x58 in hexadecimal).
 7. Wait for approximately 100 mS.
 8. Return baud rate to 9600 bps again.
 9. Output OK response <SP><CR><LF>.
-

Command : **RIGD** Function : **GRAPHIC DOWNLOAD** Command category: **READ**

Parameter : **N/A**

Example : RIGD<CR><LF> Response: *see remarks*

Remarks: When this command is sent to the SDU5600, it will respond as follows producing a level which corresponds to each frequency across the screen.

(Example):

```
===== Start from here =====  
IGD<SP><CR><LF>  
/<SP><CR><LF>  
F5.70000, L-90<SP><CR><LF>  
F5.73125, L-90<SP><CR><LF>  
(Some lines omitted)  
F7.73125, L-86<SP><CR><LF>  
F7.76250, L-86<SP><CR><LF>  
(Some lines omitted)  
F15.66875, L-90<SP><CR><LF>  
F15.70000, L-90<SP><CR><LF>  
/<SP><CR><LF>  
===== End =====
```

Produces a 'pair' of data values comprising of frequency and its level at MHz order which is defined (sandwiched) by // . In reality, there may be a discrepancy of +/- 1dBm between the value of the marker on the LCD and the level of the same marker which is calculated by this command.

Command : **RICD** Function : **CURSOR DOWNLOAD** Command category: **READ**

Parameter : **N/A**

Example : RICD<CR><LF> Response: *see remarks*

Remarks: Read output level of the cursor frequency.

(Example):

```
===== Start from here =====
f10.70000, l-78<SP>CR><LF>
===== End =====
```

Note: Use small F or L (not a capital) for this command. This produces the information in one line unlike the download plot information. In reality, there may be a discrepancy of +/- 1dBm between the value of the marker on the LCD and the level of the same marker which is calculated by this command.

Command : **RIFD** Function : **HIGH SPEED DATA DOWNLOAD** Command category: **READ**

Parameter : **N/A**

Example : RIFD<CR><LF> Response: *see remarks*

Remarks: Read output level on each frequency on the screen as 1 byte data.

(Example):

```
===== Start from here =====
IFD<SP><CR><LF>
<SP>CR><LF>
(Some lines omitted, these are level data area.) #%$-+#!
(Some lines omitted) <SP>
<SP>
<SP><CR><LF>
===== End =====
```

The level data per frequency will be presented in ASCII code which has been obtained by calculation of the label, 100 + 0x20.

Note: Use small F or L (not a capital) for this command. In reality, there may be a discrepancy of +/- 1dBm between the value of the marker on the LCD and the level of the same marker which is calculated by this command.

Command : **RIVE** Function : **READ FIRMWARE VERSION** Command category: **READ**

Parameter : **N/A**

Example : RIVE<CR><LF> Response: *see remarks*

Remarks: (Example):

```
===== Start from here =====
IVE<SP>Ver.<SP>007<SP>307C<SP><SP><CR><LF>
===== End =====
```

Produces the version information followed by IVE<SP>

Notes for programmers

Generally speaking the screen dump is preferable if graphic info (data) is wanted. On the other hand the array of frequency / level can better serve if numerical data is demanded. The array of frequency / level is faster in transfer time from the SDU5600 to the PC.

The SDU5600 accepts commands either from the PC or from its own front panel on a first come first serve basis. For example the PC has sent data to switch the SPAN bandwidth to 10MHz followed by data from the front panel setting the same parameter to 5MHz. The SDU5600 will perform the change to 10MHz then to 5MHz.

AOR is considering commissioning a PC control package for the SDU5600, keep an eye on the AOR web site for possible information:

www.aorja.com

www.aorusa.com

9 Specification

| | |
|------------------------|--------------------------------------|
| Input frequency | 10.7MHz / 45.05MHz selectable |
| Maximum frequency span | 10MHz |
| RBW | 4kHz, 32kHz, 64kHz, 128kHz |
| Dynamic range | 60dB |
| Input impedance | 50 OHM via BNC socket |
| Display screen | 5 inch (127mm) TFT Colour LCD |
| Communications | RS232C (2 ports) |
| Power requirement | 12DC @ 0.9A nominal, negative ground |
| Operation | 26 keys & main dial |
| Operating temperature | 0 to 50 degrees Celsius |
| Dimensions | 220(W) x 120(H) x 195(D) mm |
| Weight | 2.3kg |

Specifications subject to change without notice.
All trade marks acknowledged. E&OE.

Notes:



AOR Ltd

2-6-4 Misuji, Taito-ku, Tokyo 111, Japan.

Tel: +81 3 3865 1695 Fax: +81 3 3865 1697

post@ajorja.com www.ajorja.com

AOR USA INC.,

20655 S. Western Ave., Suite 112, Torrance, CA 90501 USA

Tel: 310 787 8615 Fax: 310 787 8619

info@aorusa.com www.aorusa.com